

# Simulink® 7 Reference

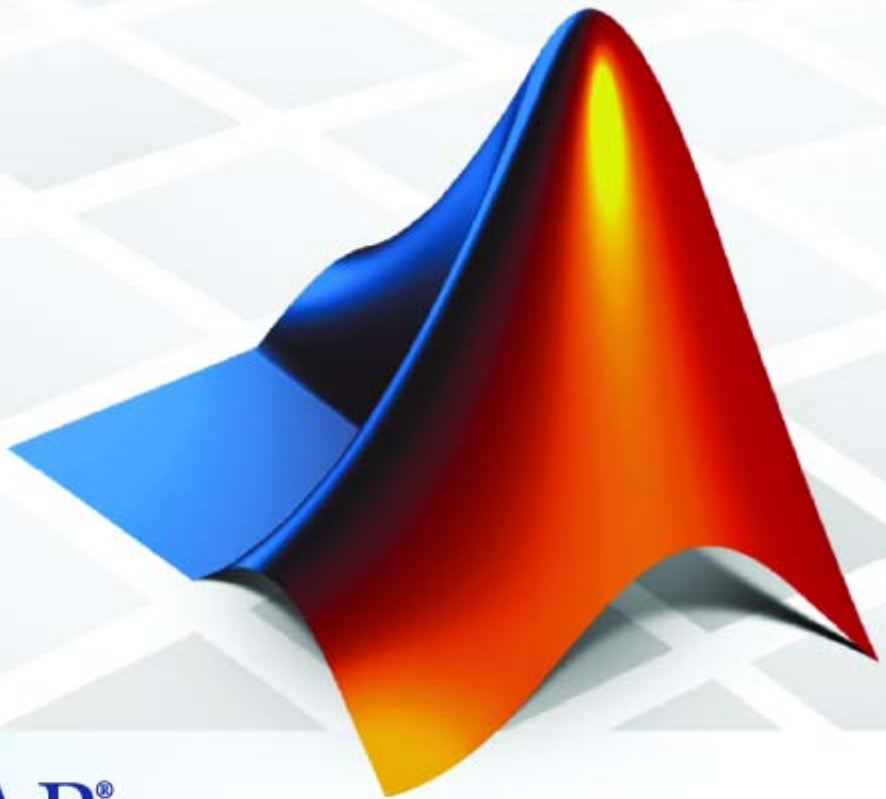

MATLAB®  
& SIMULINK®

## How to Contact The MathWorks



[www.mathworks.com](http://www.mathworks.com)  
[comp.soft-sys.matlab](mailto:comp.soft-sys.matlab)  
[www.mathworks.com/contact\\_TS.html](http://www.mathworks.com/contact_TS.html)

Web  
Newsgroup  
Technical Support



[suggest@mathworks.com](mailto:suggest@mathworks.com)  
[bugs@mathworks.com](mailto:bugs@mathworks.com)  
[doc@mathworks.com](mailto:doc@mathworks.com)  
[service@mathworks.com](mailto:service@mathworks.com)  
[info@mathworks.com](mailto:info@mathworks.com)

Product enhancement suggestions  
Bug reports  
Documentation error reports  
Order status, license renewals, passcodes  
Sales, pricing, and general information



508-647-7000 (Phone)



508-647-7001 (Fax)



The MathWorks, Inc.  
3 Apple Hill Drive  
Natick, MA 01760-2098

For contact information about worldwide offices, see the MathWorks Web site.

### *Simulink Reference*

© COPYRIGHT 2002–2007 by The MathWorks, Inc.

The software described in this document is furnished under a license agreement. The software may be used or copied only under the terms of the license agreement. No part of this manual may be photocopied or reproduced in any form without prior written consent from The MathWorks, Inc.

FEDERAL ACQUISITION: This provision applies to all acquisitions of the Program and Documentation by, for, or through the federal government of the United States. By accepting delivery of the Program or Documentation, the government hereby agrees that this software or documentation qualifies as commercial computer software or commercial computer software documentation as such terms are used or defined in FAR 12.212, DFARS Part 227.72, and DFARS 252.227-7014. Accordingly, the terms and conditions of this Agreement and only those rights specified in this Agreement, shall pertain to and govern the use, modification, reproduction, release, performance, display, and disclosure of the Program and Documentation by the federal government (or other entity acquiring for or through the federal government) and shall supersede any conflicting contractual terms or conditions. If this License fails to meet the government's needs or is inconsistent in any respect with federal procurement law, the government agrees to return the Program and Documentation, unused, to The MathWorks, Inc.

### **Trademarks**

MATLAB, Simulink, Stateflow, Handle Graphics, Real-Time Workshop, SimBiology, SimHydraulics, SimEvents, and xPC TargetBox are registered trademarks and The MathWorks, the L-shaped membrane logo, Embedded MATLAB, and PolySpace are trademarks of The MathWorks, Inc.

Other product or brand names are trademarks or registered trademarks of their respective holders.

### **Patents**

The MathWorks products are protected by one or more U.S. patents. Please see [www.mathworks.com/patents](http://www.mathworks.com/patents) for more information.

### **Revision History**

July 2002	Online only	Revised for Simulink 5 (Release 13)
April 2003	Online only	Revised for Simulink 5.1 (Release 13SP1)
April 2004	Online only	Revised for Simulink 5.1.1 (Release 13SP1+)
June 2004	Online only	Revised for Simulink 6 (Release 14)
October 2004	Online only	Revised for Simulink 6.1 (Release 14SP1)
March 2005	Online only	Revised for Simulink 6.2 (Release 14SP2)
September 2005	Online only	Revised for Simulink 6.3 (Release 14SP3)
March 2006	Online only	Revised for Simulink 6.4 (Release 2006a)
September 2006	Online only	Revised for Simulink 6.5 (Release 2006b)
March 2007	Online only	Revised for Simulink 6.6 (Release 2007a)
September 2007	Online only	Revised for Simulink 7.0 (Release 2007b)



## Blocks — By Category

**1**

---

<b>Commonly Used</b> .....	<b>1-2</b>
<b>Continuous</b> .....	<b>1-3</b>
<b>Discontinuities</b> .....	<b>1-3</b>
<b>Discrete</b> .....	<b>1-4</b>
<b>Logic and Bit Operations</b> .....	<b>1-5</b>
<b>Lookup Tables</b> .....	<b>1-7</b>
<b>Math Operations</b> .....	<b>1-8</b>
<b>Model Verification</b> .....	<b>1-10</b>
<b>Model-Wide Utilities</b> .....	<b>1-11</b>
<b>Ports &amp; Subsystems</b> .....	<b>1-11</b>
<b>Signal Attributes</b> .....	<b>1-13</b>
<b>Signal Routing</b> .....	<b>1-14</b>
<b>Sinks</b> .....	<b>1-15</b>
<b>Sources</b> .....	<b>1-15</b>
<b>User-Defined Functions</b> .....	<b>1-17</b>

<b>Additional Math &amp; Discrete</b> .....	<b>1-17</b>
Additional Discrete .....	<b>1-17</b>
Additional Math: Increment — Decrement .....	<b>1-19</b>

## Blocks — Alphabetical List

**2**

---

## Functions — By Category

**3**

---

<b>Model Construction</b> .....	<b>3-2</b>
<b>Simulation</b> .....	<b>3-6</b>
<b>Linearization and Trimming</b> .....	<b>3-7</b>
<b>Data Type</b> .....	<b>3-8</b>

## Functions — Alphabetical List

**4**

---

## Mask Icon Drawing Commands

**5**

---

<b>Command Summary</b> .....	<b>5-2</b>
<b>Mask Icon Drawing Commands — Alphabetical List</b> ..	<b>5-3</b>

## Simulink Debugger Commands

### 6

<b>Command Summary</b> .....	<b>6-2</b>
<b>Simulink Debugger Commands — Alphabetical List</b> ..	<b>6-5</b>

## Data Object Classes

### 7

<b>Class Summary</b> .....	<b>7-2</b>
<b>Classes — Alphabetical List</b> .....	<b>7-4</b>

## Model and Block Parameters

### 8

<b>Model Parameters</b> .....	<b>8-2</b>
About Model Parameters .....	<b>8-2</b>
Examples of Setting Model Parameters .....	<b>8-65</b>
<b>Common Block Parameters</b> .....	<b>8-66</b>
About Common Block Parameters .....	<b>8-66</b>
Examples of Setting Block Parameters .....	<b>8-78</b>
<b>Block-Specific Parameters</b> .....	<b>8-79</b>
<b>Mask Parameters</b> .....	<b>8-183</b>
About Mask Parameters .....	<b>8-183</b>
Setting Mask Parameters .....	<b>8-188</b>
How Masked Parameters are Stored .....	<b>8-188</b>

**9**

<b>Model File Contents</b> .....	<b>9-2</b>
About Model File Formats .....	<b>9-2</b>
Model Section .....	<b>9-4</b>
Simulink.ConfigSet Section .....	<b>9-5</b>
BlockDefaults Section .....	<b>9-5</b>
BlockParameterDefaults Section .....	<b>9-6</b>
AnnotationDefaults Section .....	<b>9-7</b>
LineDefaults Section .....	<b>9-7</b>
System Section .....	<b>9-7</b>

**Model Advisor Checks**

**10**

<b>Simulink Checks</b> .....	<b>10-2</b>
Simulink Overview .....	<b>10-3</b>
Check model, local libraries, and referenced models for known upgrade issues .....	<b>10-3</b>
Identify unconnected lines, input ports, and output ports .....	<b>10-5</b>
Check root model Inport block specifications .....	<b>10-6</b>
Check optimization settings .....	<b>10-7</b>
Check for parameter tunability information ignored for referenced models .....	<b>10-8</b>
Check for implicit signal resolution .....	<b>10-9</b>
Check for optimal bus virtuality .....	<b>10-10</b>
Check for Discrete-Time Integrator blocks with initial condition uncertainty .....	<b>10-11</b>
Identify disabled library links .....	<b>10-12</b>
Identify parameterized library links .....	<b>10-13</b>
Check for proper bus usage .....	<b>10-14</b>
Check for potentially delayed function-call subsystem return values .....	<b>10-15</b>
Identify block output signals with continuous sample time and non-floating point data type .....	<b>10-16</b>
Check for proper Merge block usage .....	<b>10-17</b>







# Blocks — By Category

---

Commonly Used (p. 1-2)	Commonly used blocks
Continuous (p. 1-3)	Define continuous states
Discontinuities (p. 1-3)	Define discontinuous states
Discrete (p. 1-4)	Define discrete states
Logic and Bit Operations (p. 1-5)	Perform logic and bit operations
Lookup Tables (p. 1-7)	Support lookup tables
Math Operations (p. 1-8)	Perform math operations
Model Verification (p. 1-10)	Perform model verification
Model-Wide Utilities (p. 1-11)	Support model-wide operations
Ports & Subsystems (p. 1-11)	Support ports and subsystems
Signal Attributes (p. 1-13)	Support signal attributes
Signal Routing (p. 1-14)	Support signal routing
Sinks (p. 1-15)	Receive output from other blocks
Sources (p. 1-15)	Input to other blocks
User-Defined Functions (p. 1-17)	Support custom functions
Additional Math & Discrete (p. 1-17)	Provide additional math and discrete support

## Commonly Used

Bus Creator	Create signal bus
Bus Selector	Select signals from incoming bus
Constant	Generate constant value
Data Type Conversion	Convert input signal to specified data type
Demux	Extract and output elements of bus or vector signal
Discrete-Time Integrator	Perform discrete-time integration or accumulation of signal
Gain	Multiply input by constant
Ground	Ground unconnected input port
Inport	Create input port for subsystem or external input
Integrator	Integrate signal
Logical Operator	Perform specified logical operation on input
Mux	Combine several input signals into vector
Outport	Create output port for subsystem or external output
Product	Multiply or divide inputs
Relational Operator	Perform specified relational operation on inputs
Saturation	Limit range of signal
Scope, Floating Scope, Signal Viewer	Display signals generated during simulation
Subsystem, Atomic Subsystem, CodeReuse Subsystem	Represent system within another system

Sum, Add, Subtract, Sum of Elements	Add or subtract inputs
Switch	Switch output between first input and third input based on value of second input
Terminator	Terminate unconnected output port
Unit Delay	Delay signal one sample period

## Continuous

Derivative	Output time derivative of input
Integrator	Integrate signal
State-Space	Implement linear state-space system
Transfer Fcn	Model linear system by transfer function
Transport Delay	Delay input by given amount of time
Variable Time Delay, Variable Transport Delay	Delay input by variable amount of time
Zero-Pole	Model system by zero-pole-gain transfer function

## Discontinuities

Backlash	Model behavior of system with play
Coulomb and Viscous Friction	Model discontinuity at zero, with linear gain elsewhere
Dead Zone	Provide region of zero output
Dead Zone Dynamic	Set inputs within bounds to zero

Hit Crossing	Detect crossing point
Quantizer	Discretize input at specified interval
Rate Limiter	Limit rate of change of signal
Rate Limiter Dynamic	Limit rising and falling rates of signal
Relay	Switch output between two constants
Saturation	Limit range of signal
Saturation Dynamic	Bound range of input
Wrap To Zero	Set output to zero if input is above threshold

## Discrete

Difference	Calculate change in signal over one time step
Discrete Derivative	Compute discrete time derivative
Discrete Filter	Model IIR and FIR filters
Discrete State-Space	Implement discrete state-space system
Discrete Transfer Fcn	Implement discrete transfer function
Discrete Zero-Pole	Model system defined by zeros and poles of discrete transfer function
Discrete-Time Integrator	Perform discrete-time integration or accumulation of signal
First-Order Hold	Implement first-order sample-and-hold
Integer Delay	Delay signal N sample periods
Memory	Output input from previous time step

Tapped Delay	Delay scalar signal multiple sample periods and output all delayed versions
Transfer Fcn First Order	Implement discrete-time first order transfer function
Transfer Fcn Lead or Lag	Implement discrete-time lead or lag compensator
Transfer Fcn Real Zero	Implement discrete-time transfer function that has real zero and no pole
Unit Delay	Delay signal one sample period
Weighted Moving Average	Implement weighted moving average
Zero-Order Hold	Implement zero-order hold of one sample period

## Logic and Bit Operations

Bit Clear	Set specified bit of stored integer to zero
Bit Set	Set specified bit of stored integer to one
Bitwise Operator	Perform specified bitwise operation on inputs
Combinatorial Logic	Implement truth table
Compare To Constant	Determine how signal compares to specified constant
Compare To Zero	Determine how signal compares to zero
Detect Change	Detect change in signal's value
Detect Decrease	Detect decrease in signal's value

Detect Fall Negative	Detect falling edge when signal's value decreases to strictly negative value, and its previous value was nonnegative
Detect Fall Nonpositive	Detect falling edge when signal's value decreases to nonpositive value, and its previous value was strictly positive
Detect Increase	Detect increase in signal's value
Detect Rise Nonnegative	Detect rising edge when signal's value increases to nonnegative value, and its previous value was strictly negative
Detect Rise Positive	Detect rising edge when signal's value increases to strictly positive value, and its previous value was nonpositive
Extract Bits	Output selection of contiguous bits from input signal
Interval Test	Determine if signal is in specified interval
Interval Test Dynamic	Determine if signal is in specified interval
Logical Operator	Perform specified logical operation on input
Relational Operator	Perform specified relational operation on inputs
Shift Arithmetic	Shift bits and/or binary point of signal



## Lookup Tables

Cosine	Implement cosine function in fixed-point using lookup table approach that exploits quarter wave symmetry
Direct Lookup Table (n-D)	Index into N-dimensional table to retrieve element, column, or 2-D matrix
Interpolation (n-D) Using PreLookup (Obsolete)	Perform high-performance constant or linear interpolation, mapping N input values to sampled representation of function in N variables via output from PreLookup Index Search block
Interpolation Using Prelookup	Use output of Prelookup block to accelerate approximation of N-dimensional function
Lookup Table	Approximate one-dimensional function
Lookup Table (2-D)	Approximate two-dimensional function
Lookup Table (n-D)	Approximate N-dimensional function
Lookup Table Dynamic	Approximate one-dimensional function using dynamically specified table
Prelookup	Compute index and fraction for Interpolation Using Prelookup block

PreLookup Index Search (Obsolete)	First stage of high-performance constant or linear interpolation that performs index search and interval fraction calculation for input on breakpoint set
Sine	Implement sine wave in fixed-point using lookup table approach that exploits quarter wave symmetry

## Math Operations

Abs	Output absolute value of input
Algebraic Constraint	Constrain input signal to zero
Assignment	Assign values to specified elements of signal
Bias	Add bias to input
Complex to Magnitude-Angle	Compute magnitude and/or phase angle of complex signal
Complex to Real-Imag	Output real and imaginary parts of complex input signal
Divide	Multiply or divide inputs
Dot Product	Generate dot product of two vectors
Gain	Multiply input by constant
Magnitude-Angle to Complex	Convert magnitude and/or a phase angle signal to complex signal
Math Function	Perform mathematical function
Matrix Concatenate, Vector Concatenate	Concatenate input signals of same data type to create contiguous output signal
MinMax	Output minimum or maximum input value

MinMax Running Resettable	Determine minimum or maximum of signal over time
Permute Dimensions	Rearrange dimensions of multidimensional array dimensions
Polynomial	Perform evaluation of polynomial coefficients on input values
Product	Multiply or divide inputs
Product of Elements	Multiply or divide inputs
Real-Imag to Complex	Convert real and/or imaginary inputs to complex signal
Reshape	Change dimensionality of signal
Rounding Function	Apply rounding function to signal
Sign	Indicate sign of input
Sine Wave Function	Generate sine wave, using external signal as time source
Slider Gain	Vary scalar gain using slider
Squeeze	Remove singleton dimensions from multidimensional signal
Sum, Add, Subtract, Sum of Elements	Add or subtract inputs
Trigonometric Function	Perform trigonometric function
Unary Minus	Negate input
Weighted Sample Time Math	Support calculations involving sample time

## Model Verification

Assertion	Check whether signal is nonzero
Check Discrete Gradient	Check that absolute value of difference between successive samples of discrete signal is less than upper bound
Check Dynamic Gap	Check that gap of possibly varying width occurs in range of signal's amplitudes
Check Dynamic Lower Bound	Check that one signal is always less than another signal
Check Dynamic Range	Check that signal falls inside range of amplitudes that varies from time step to time step
Check Dynamic Upper Bound	Check that one signal is always greater than another signal
Check Input Resolution	Check that input signal has specified resolution
Check Static Gap	Check that gap exists in signal's range of amplitudes
Check Static Lower Bound	Check that signal is greater than (or optionally equal to) static lower bound
Check Static Range	Check that signal falls inside fixed range of amplitudes
Check Static Upper Bound	Check that signal is less than (or optionally equal to) static upper bound

## Model-Wide Utilities

Block Support Table	View data type support for Simulink blocks
DocBlock	Create text that documents model and save text with model
Model Info	Display revision control information in model
Time-Based Linearization	Generate linear models in base workspace at specific times
Trigger-Based Linearization	Generate linear models in base workspace when triggered

## Ports & Subsystems

Action Port	Implement Action subsystems used by <code>if</code> and <code>switch</code> control flow statements in Simulink
Configurable Subsystem	Represent any block selected from user-specified library of blocks
Enable	Add enabling port to subsystem
Enabled and Triggered Subsystem	Represent subsystem whose execution is enabled and triggered by external input
Enabled Subsystem	Represent subsystem whose execution is enabled by external input
For Iterator Subsystem	Represent subsystem that executes repeatedly during simulation time step

Function-Call Generator	Execute function-call subsystem specified number of times at specified rate
Function-Call Subsystem	Represent subsystem that can be invoked as function by another block
If	Model if - else control flow
If Action Subsystem	Represent subsystem whose execution is triggered by If block
Inport	Create input port for subsystem or external input
Model	Include model as block in another model
Outport	Create output port for subsystem or external output
Subsystem, Atomic Subsystem, CodeReuse Subsystem	Represent system within another system
Switch Case	Implement C-like switch control flow statement
Switch Case Action Subsystem	Represent subsystem whose execution is triggered by Switch Case block
Trigger	Add trigger port to subsystem or function-call model
Triggered Subsystem	Represent subsystem whose execution is triggered by external input
While Iterator Subsystem	Represent subsystem that executes repeatedly while condition is satisfied during simulation time step

## Signal Attributes

Bus to Vector	Convert virtual bus to vector
Data Type Conversion	Convert input signal to specified data type
Data Type Conversion Inherited	Convert from one data type to another using inherited data type and scaling
Data Type Duplicate	Force all inputs to same data type
Data Type Propagation	Set data type and scaling of propagated signal based on information from reference signals
Data Type Scaling Strip	Remove scaling and map to built in integer
IC	Set initial value of signal
Probe	Output signal's attributes, including width, dimensionality, sample time, and/or complex signal flag
Rate Transition	Handle transfer of data between blocks operating at different rates
Signal Conversion	Convert signal to new type without altering signal values
Signal Specification	Specify desired dimensions, sample time, data type, numeric type, and other attributes of signal
Weighted Sample Time	Support calculations involving sample time
Width	Output width of input vector

## Signal Routing

Bus Assignment	Assign values to specified elements of bus
Bus Creator	Create signal bus
Bus Selector	Select signals from incoming bus
Data Store Memory	Define data store
Data Store Read	Read data from data store
Data Store Write	Write data to data store
Demux	Extract and output elements of bus or vector signal
Environment Controller	Create branches of block diagram that apply only to simulation or only to code generation
From	Accept input from Goto block
Goto	Pass block input to From blocks
Goto Tag Visibility	Define scope of Goto block tag
Index Vector	Switch output between different inputs based on value of first input
Manual Switch	Switch between two inputs
Merge	Combine multiple signals into single signal
Multiport Switch	Choose between multiple block inputs
Mux	Combine several input signals into vector
Selector	Select input elements from vector, matrix, or multidimensional signal
Switch	Switch output between first input and third input based on value of second input



## Sinks

Display	Show value of input
Outport	Create output port for subsystem or external output
Scope, Floating Scope, Signal Viewer Scope	Display signals generated during simulation
Stop Simulation	Stop simulation when input is nonzero
Terminator	Terminate unconnected output port
To File	Write data to file
To Workspace	Write data to workspace
XY Graph	Display X-Y plot of signals using MATLAB figure window

## Sources

Band-Limited White Noise	Introduce white noise into continuous system
Chirp Signal	Generate sine wave with increasing frequency
Clock	Display and provide simulation time
Constant	Generate constant value
Counter Free-Running	Count up and overflow back to zero after maximum value possible is reached for specified number of bits
Counter Limited	Count up and wrap back to zero after outputting specified upper limit
Digital Clock	Output simulation time at specified sampling interval

From File	Read data from MAT file
From Workspace	Read data from workspace
Ground	Ground unconnected input port
Inport	Create input port for subsystem or external input
Pulse Generator	Generate square wave pulses at regular intervals
Ramp	Generate constantly increasing or decreasing signal
Random Number	Generate normally distributed random numbers
Repeating Sequence	Generate arbitrarily shaped periodic signal
Repeating Sequence Interpolated	Output discrete-time sequence and repeat, interpolating between data points
Repeating Sequence Stair	Output and repeat discrete time sequence
Signal Builder	Create and generate interchangeable groups of signals whose waveforms are piecewise linear
Signal Generator	Generate various waveforms
Sine Wave	Generate sine wave
Step	Generate step function
Uniform Random Number	Generate uniformly distributed random numbers

## User-Defined Functions

Embedded MATLAB Function	Include MATLAB code in models that generate embeddable C code
Fcn	Apply specified expression to input
Level-2 M-File S-Function	Use Level-2 M-file S-function in model
MATLAB Fcn	Apply MATLAB function or expression to input
S-Function	Include S-function in model
S-Function Builder	Create S-function from C code that you provide

## Additional Math & Discrete

Additional Discrete (p. 1-17)	Provide additional discrete math support
Additional Math: Increment — Decrement (p. 1-19)	Increment or decrement value of signal by one

### Additional Discrete

Fixed-Point State-Space	Implement discrete-time state space
Transfer Fcn Direct Form II	Implement Direct Form II realization of transfer function
Transfer Fcn Direct Form II Time Varying	Implement time varying Direct Form II realization of transfer function
Unit Delay Enabled	Delay signal one sample period, if external enable signal is on

Unit Delay Enabled External IC	Delay signal one sample period, if external enable signal is on, with external initial condition
Unit Delay Enabled Resettable	Delay signal one sample period, if external enable signal is on, with external Boolean reset
Unit Delay Enabled Resettable External IC	Delay signal one sample period, if external enable signal is on, with external Boolean reset and initial condition
Unit Delay External IC	Delay signal one sample period, with external initial condition
Unit Delay Resettable	Delay signal one sample period, with external Boolean reset
Unit Delay Resettable External IC	Delay signal one sample period, with external Boolean reset and initial condition
Unit Delay With Preview Enabled	Output signal and signal delayed by one sample period, if external enable signal is on
Unit Delay With Preview Enabled Resettable	Output signal and signal delayed by one sample period, if external enable signal is on, with external Boolean reset
Unit Delay With Preview Enabled Resettable External RV	Output signal and signal delayed by one sample period, if external enable signal is on, with external RV reset
Unit Delay With Preview Resettable	Output signal and signal delayed by one sample period, with external Boolean reset
Unit Delay With Preview Resettable External RV	Output signal and signal delayed by one sample period, with external RV reset

## **Additional Math: Increment – Decrement**

Decrement Real World	Decrease real world value of signal by one
Decrement Stored Integer	Decrease stored integer value of signal by one
Decrement Time To Zero	Decrease real-world value of signal by sample time, but only to zero
Decrement To Zero	Decrease real-world value of signal by one, but only to zero
Increment Real World	Increase real world value of signal by one
Increment Stored Integer	Increase stored integer value of signal by one



# Blocks — Alphabetical List

---

# Abs

---

**Purpose** Output absolute value of input

**Library** Math Operations

**Description** The Abs block outputs the absolute value of the input.



For signed data types, the absolute value of the most negative value is problematic since it is not representable by the data type. In this case, the behavior of the block is controlled by the **Saturate on integer overflow** check box. If checked, the absolute value of the data type saturates to the most positive representable value. If not checked, the absolute value of the most negative value represented by the data type has no effect.

For example, suppose the block input is an 8-bit signed integer. The range of this data type is from -128 to 127, and the absolute value of -128 is not representable. If you select the **Saturate on integer overflow** check box, then the absolute value of -128 is 127. If it is not selected, then the absolute value of -128 remains at -128.

**Data Type Support** The Abs block accepts real signals of any data type supported by Simulink®, except Boolean. The Abs block supports real fixed-point data types. The block also accepts complex single and double inputs.

For a discussion on the data types supported by Simulink, see “Data Types Supported by Simulink” in the “Working with Data” chapter of the Using Simulink documentation.



## Parameters and Dialog Box

The **Main** pane of the Abs block dialog appears as follows:

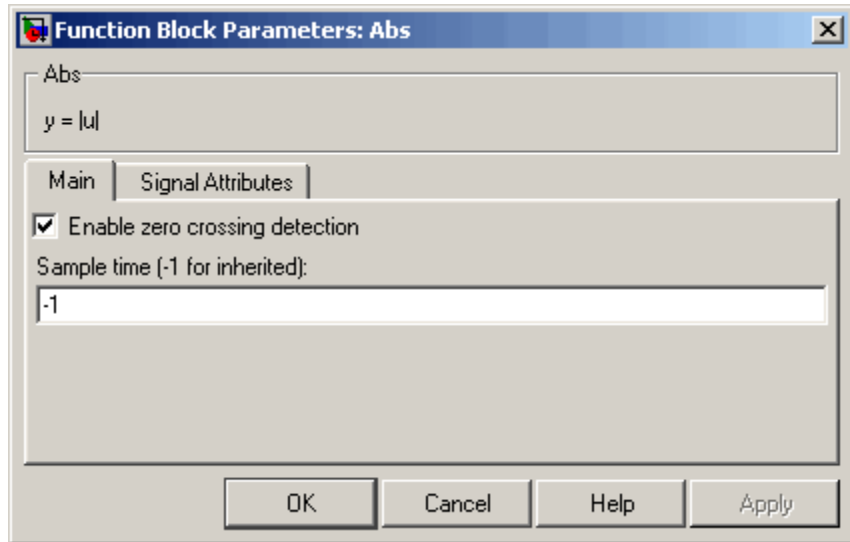

### Enable zero crossing detection

Select to enable zero crossing detection. For more information, see “Zero-Crossing Detection” in the “How Simulink Works” chapter of the Using Simulink documentation.

### Sample time (-1 for inherited)

Specify the time interval between samples. To inherit the sample time, set this parameter to -1. See Specifying Sample Time in the “How Simulink Works” chapter of the Using Simulink documentation.

The **Signal Attributes** pane of the Abs block dialog appears as follows:

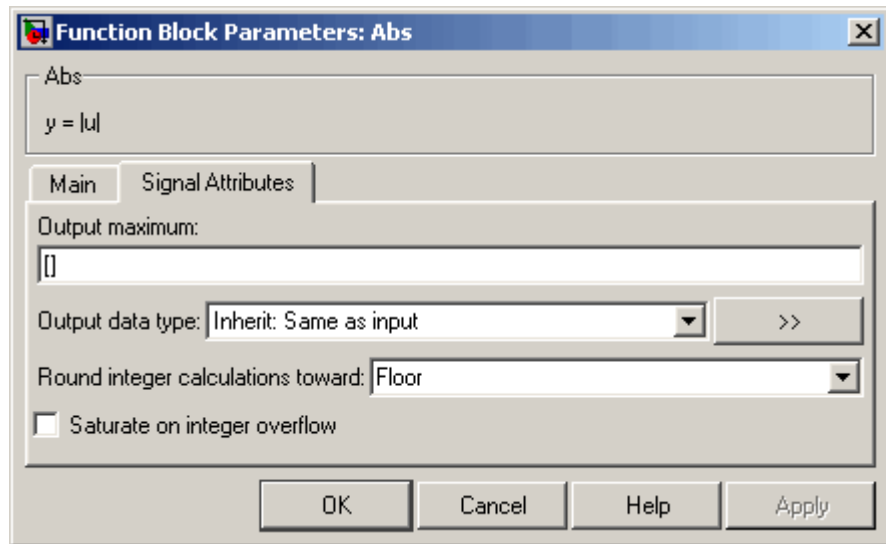

## Output maximum

Specify the maximum value that the block should output. The default value, [], is equivalent to Inf. Simulink uses this value to perform:

- Simulation range checking (see “Checking Signal Ranges”)
- Automatic scaling of fixed-point data types

## Output data type

Specify the output data type. You can set it to:

- A rule that inherits a data type, for example, Inherit: Inherit via back propagation
- The name of a built-in data type, for example, single
- The name of a data type object, for example, a Simulink.NumericType object
- An expression that evaluates to a data type, for example, float('single')

Click the **Show data type assistant** button  to display the **Data Type Assistant**, which helps you set the **Output data type** parameter.

See “Specifying Block Output Data Types” in *Using Simulink* for more information.

**Lock output scaling against changes by the autoscaling tool**

Select to lock scaling of outputs. This parameter is visible only if you enter an expression for the **Output data type** parameter.

**Round integer calculations toward**

Select the rounding mode for fixed-point operations.

**Saturate on integer overflow**

Select to have overflows saturate. If selected, the block maps signed integer input elements corresponding to the most negative value of that data type to the most positive value of that data type:

- For 8-bit integers, -128 maps to 127.
- For 16-bit integers, -32768 maps to 32767.
- For 32-bit integers, -2147483648 maps to 2147483647.

Otherwise, the block does not act on signed integer input elements corresponding to the most negative value of that data type:

- For 8-bit integers, -128 remains -128.
- For 16-bit integers, -32768 remains -32768.
- For 32-bit integers, -2147483648 remains -2147483648.

**Characteristics**

Direct Feedthrough	Yes
Sample Time	Specified in the <b>Sample time</b> parameter
Dimensionalized	Yes

# Abs

---

Multidimensionalized	Yes
Zero Crossing	Yes, if enabled

## Purpose

Implement Action subsystems used by `if` and `switch` control flow statements in Simulink

## Library

Ports & Subsystems

## Description

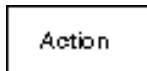

Action Port blocks implement Action subsystems used in `if` and `switch` control flow statements. The Action Port block is available in the If Action Subsystem and the Switch Case Action Subsystem. See the references for the If and Switch Case blocks for examples using Action Port blocks.

Use Action Port blocks to create Action subsystems as follows:

- 1 Place a subsystem in the system containing the If or Switch Case block.

You can use an ordinary subsystem or an atomic subsystem. In either case, the resulting Action subsystem is atomic.

- 2 Add an Action Port to the new subsystem.

This adds an input port named Action to the subsystem, which is now an Action subsystem.

Action subsystems execute their programming in response to the conditional outputs of an If or Switch Case block. Use Action subsystems as follows:

- 1 Create an Action subsystem for each output port configured for an If or Switch Case block.
- 2 Connect each output port (if, else, or elseif ports for the If block; case or default ports for the Switch Case block) to the Action port on an Action subsystem.

When the connection is made, the icon for the subsystem and the Action Port block it contains are changed to the name of the output

# Action Port

port for the If or Switch Case block (i.e., if{ }, else{ }, elseif{ }, case{ }, or default{ }).

- 3 Open the new subsystem and add the diagram that you want to execute in response to the condition this subsystem covers.

The Action Port block has only the **States when execution is resumed** parameter in its parameters dialog. If you set this field to held (the default value) for an Action Port block, the states of its Action subsystem are retained between calls even if other member Action subsystems of an if-else or switch control flow statement are called. If you set the **States when execution is resumed** field to reset, the states of a member Action subsystem are reset to initial values when it is reenabled.

---

**Note** All blocks in an Action subsystem driven by an If or Switch Case block must run at the same rate as the driving block.

---

## Data Type Support

There are no data inputs or outputs for Action Port blocks.

## Parameters and Dialog Box

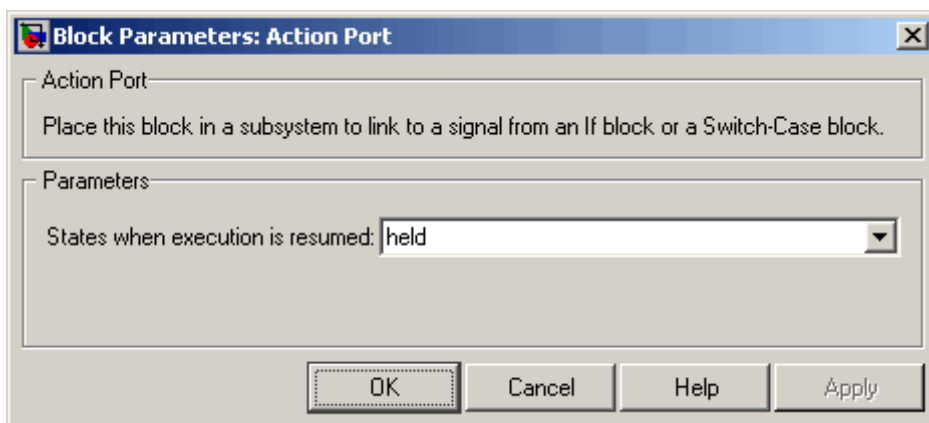

## States when execution is resumed

Specifies how to handle internal states when the subsystem of this Action Port block is reenabled.

Set this field to `held` (the default value) to make sure that the Action subsystem states retain their previous values when the subsystem is reenabled. Otherwise, set this field to `reset` if you want the states of the Action subsystem to be reinitialized when the subsystem is reenabled.

Reenablement of a subsystem occurs when it is called and the condition of the call is true after having been previously false. In the following example, the Action Port blocks for both Action subsystems A and B have the **States when execution is resumed** parameter set to `reset`.

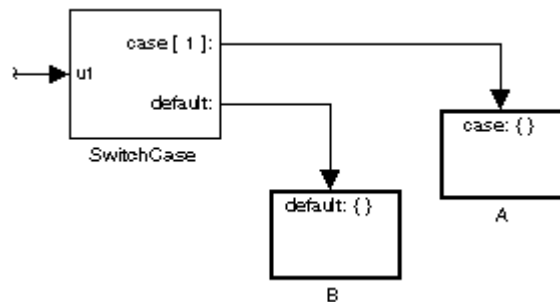

If `case[1]` is true, Action subsystem A is called. This implies that the default condition is false. When B is later called for the default condition, its states are reset. In the same way, Action subsystem A's states are reset when it is called right after Action subsystem B is called.

Repeated calls to a case's Action subsystem do not reset its states. If A is called again right after a previous call to A, this does not

## Action Port

---

reset A's states because its condition, case[1], was not previously false. The same applies to B.

### Characteristics

Sample Time	Inherited from driving If or Switch Case block
-------------	--



**Purpose** Constrain input signal to zero

**Library** Math Operations

## Description

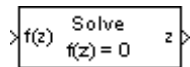

The Algebraic Constraint block constrains the input signal  $f(z)$  to zero and outputs an algebraic state  $z$ . The block outputs the value necessary to produce a zero at the input. The output must affect the input through some direct feedback path, i.e., the feedback path solely contains blocks with direct feedthrough. This enables you to specify algebraic equations for index 1 differential/algebraic systems (DAEs).

By default, the **Initial guess** parameter is zero. You can improve the efficiency of the algebraic loop solver by providing an **Initial guess** for the algebraic state  $z$  that is close to the solution value.

For example, the following model solves these equations.

$$\begin{aligned} z_2 + z_1 &= 1 \\ z_2 - z_1 &= 1 \end{aligned}$$

The solution is  $z_2 = 1$ ,  $z_1 = 0$ , as the Display blocks show.

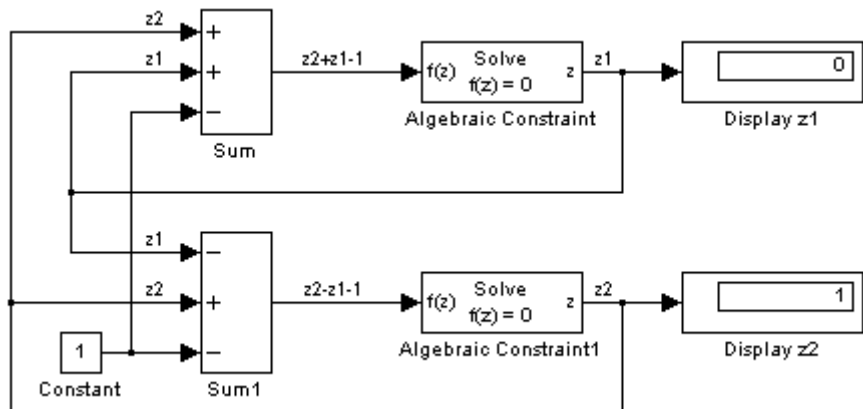

# Algebraic Constraint

## Data Type Support

The Algebraic Constraint block accepts and outputs real values of type double.

## Parameters and Dialog Box

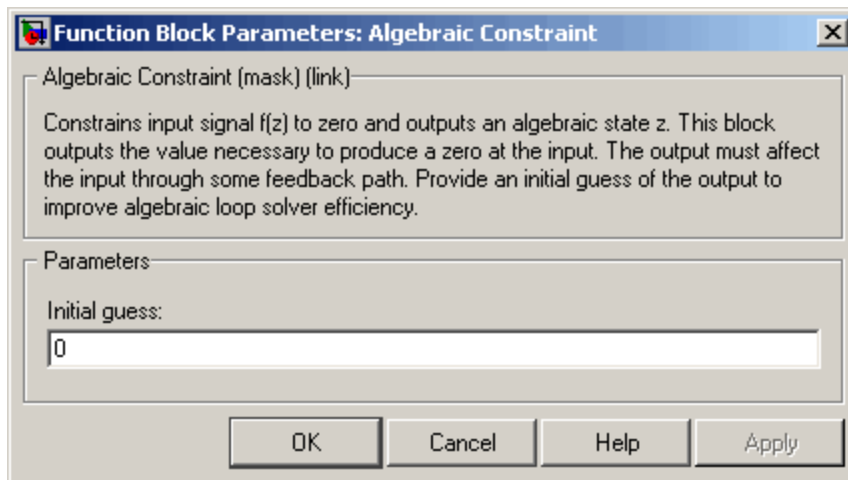

### Initial guess

An initial guess for the solution value. The default is 0.

## Characteristics

Direct Feedthrough	Yes
Sample Time	Inherited from driving block
Scalar Expansion	No
Dimensionalized	Yes
Zero-Crossing	No

**Purpose** Check whether signal is nonzero

**Library** Model Verification

## Description

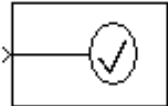

The Assertion block checks whether any of the elements of the signal at its input is nonzero. If all elements are nonzero, the block does nothing. If any element is zero, the block halts the simulation, by default, and displays an error message. The block's parameter dialog box allows you to

- Specify that the block should display an error message when the assertion fails but allow the simulation to continue.
- Specify an M-expression to be evaluated when the assertion fails.
- Enable or disable the assertion.

You can also use the **Model Verification block enabling** setting on the **Data Validity** diagnostics pane of the **Configuration Parameters** dialog box to enable or disable all Assertion blocks in a model.

The Assertion block and its companion blocks in the Model Verification library are intended to facilitate creation of self-validating models. For example, you can use model verification blocks to test that signals do not exceed specified limits during simulation. When you are satisfied that a model is correct, you can turn error checking off by disabling the verification blocks. You do not have to physically remove them from the model. If you need to modify a model, you can temporarily turn the verification blocks back on to ensure that your changes do not break the model.

## Data Type Support

The Assertion block accepts input signals of any dimensions and any data type supported by Simulink, including fixed-point data types.

For a discussion on the data types supported by Simulink, see “Data Types Supported by Simulink” in the “Working with Data” chapter of the Using Simulink documentation.

# Assertion

## Parameters and Dialog Box

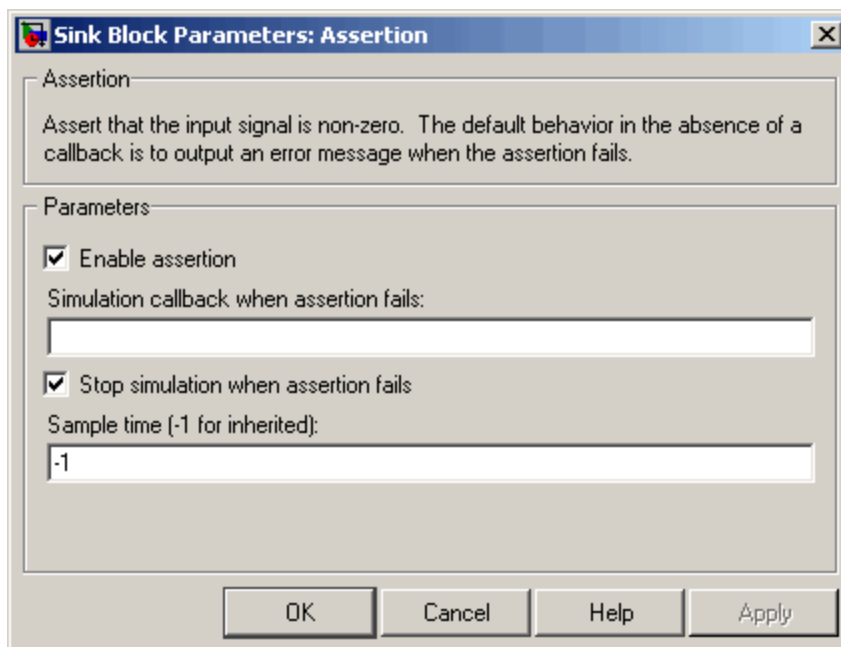

### Enable Assertion

Unchecking this option disables the Assertion block, that is, causes the model to behave as if the Assertion block did not exist. The **Model Verification block enabling** setting on the **Data Validity** diagnostics pane of the **Configuration Parameters** dialog box allows you to enable or disable all Assertion blocks in a model regardless of the setting of this option.

### Simulation callback when assertion fails

An M-expression to be evaluated when the assertion fails.

### Stop simulation when assertion fails

If checked, this option causes the Assertion block to halt the simulation when the block's input is zero and display an error message in the **Simulation Diagnostics** viewer. Otherwise, the

block displays a warning message in the MATLAB® Command Window and continues the simulation.

**Sample time (-1 for inherited)**

Specify the time interval between samples. To inherit the sample time, set this parameter to -1. See Specifying Sample Time in the “How Simulink Works” chapter of the Using Simulink documentation.

**Characteristics**

Direct Feedthrough	No
Sample Time	Inherited from driving block
Scalar Expansion	No
Dimensionalized	Yes
Zero Crossing	No

# Assignment

---

**Purpose** Assign values to specified elements of signal

**Library** Math Operations

## Description

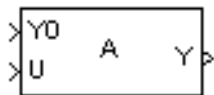

The Assignment block assigns values to specified elements of the signal. You can specify the indices of the elements to be assigned values either by entering the indices in the block's dialog box or by connecting an external indices source or sources to the block. The signal at the block's data port, labeled U, specifies values to be assigned to Y. The block replaces the specified elements of Y with elements from the data signal, leaving unassigned elements unchanged from their initial values. If the parameter **Initialize output** has a value of Initialize using input port <Y0>, the signal at the input port Y0 initializes the output. If this parameter is set to Specify size for each dimension in table, the **Output Size** parameter requires you to specify the size of the block's output signal. The parameter dialog box and the block's appearance change to reflect the number of dimensions of the output. The **Initialize output** parameter appears only if you select Index vector (port) or Starting index (port) for the **Index Option** parameter.

Based on the value you enter for the **Number of output dimensions** parameter, a table of index options is displayed. Each row of the table corresponds to one of the output dimensions in **Number of output dimensions**. For each dimension, you can define the elements of the signal to work with. Specify a vector signal as a 1-D signal and a matrix signal as a 2-D signal. When you configure the Assignment block for multidimensional signal operations, the block icon changes.

For example, assume a 5-D signal with a one-based index mode. The table in the Assignment block dialog changes to include one row for each dimension. If you define each dimension with the following entries:

- 1  
**Index Option**, select Assign all
- 2  
**Index Option**, select Index vector (dialog)

**Index**, enter [1 3 5]

- 3

**Index Option**, select Starting index (dialog)

**Index**, enter 4

- 4

**Index Option**, select Starting index (port)

- 5

**Index Option**, select Index vector (port)

The assigned values will be  $Y(1:\text{end}, [1\ 3\ 5], 4:3+\text{size}(U,3), \text{Idx4}:\text{Idx4}+\text{size}(U,4)-1, \text{Idx5})=U$ , where  $\text{Idx4}$  and  $\text{Idx5}$  are the input ports for dimensions 4 and 5.

The Assignment block's data port is labeled U. The rest of this section refers to the data port as U to simplify the explanation of the block's usage.

You can use the block to assign values to vector, matrix, or multidimensional signals.

## Iterated Assignment

You can use the Assignment block to assign values computed in a For or While Iterator loop to successive elements of a vector, matrix, or multidimensional signal in a single time step. For example, the following model uses a For Iterator block to create a vector signal each of whose elements equals  $3*i$  where  $i$  is the index of the element.

# Assignment

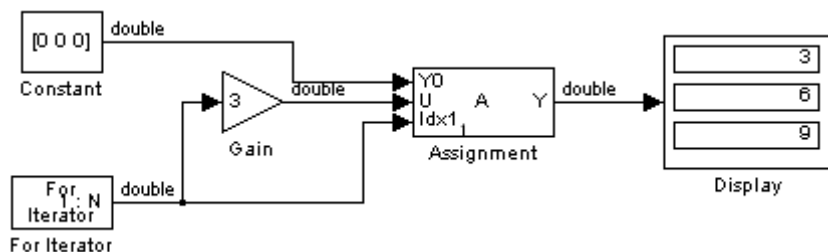

Iterated assignment uses an iterator (For or While) block to generate the indices required by the Assignment block. On the first iteration of an iterated assignment, the Assignment block copies the first input (Y0) to the output (Y) and assigns the second input (U) to the output  $Y(E_1)$ . On successive iterations, the Assignment block simply assigns the current value of U to  $Y(E_i)$ , i.e., without first copying Y0 to Y. All of this occurs in a single time step.

## Data Type Support

The data and initialization ports of the Assignment block accept signals of any data type supported by Simulink, including fixed-point data types. The external indices port accepts any built-in data type, except Boolean data types.

For a discussion on the data types supported by Simulink, see “Data Types Supported by Simulink” in the “Working with Data” chapter of the Using Simulink documentation.



## Parameters and Dialog Box

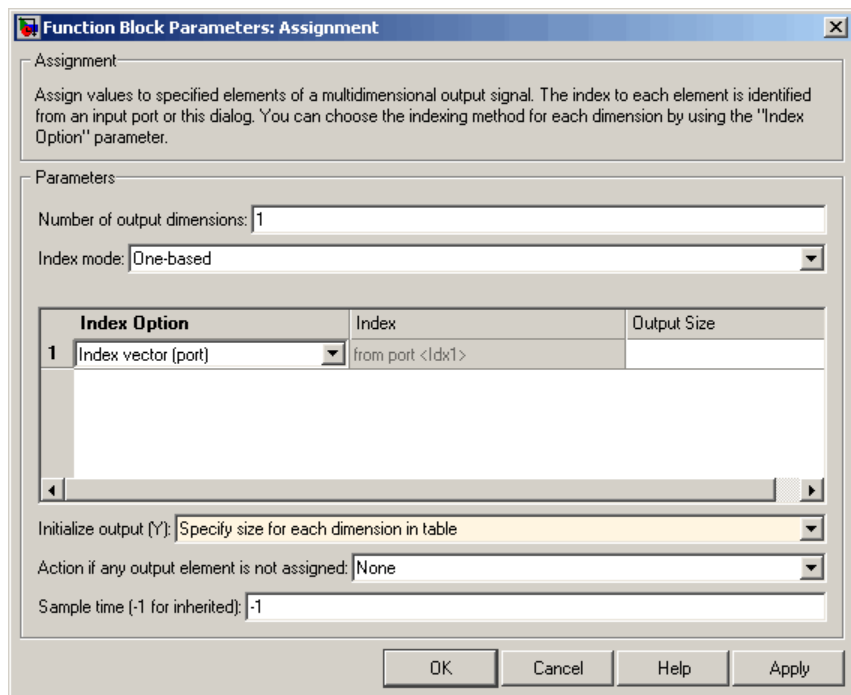

### Number of output dimensions

Enter the number of dimensions of the output signal.

### Index mode

Specifies the indexing mode: One-based or Zero-based. If One-based is selected, an index of 1 specifies the first element of the input vector, 2, the second element, and so on. If Zero-based is selected, an index of 0 specifies the first element of the input vector, 1, the second element, and so on.

### Index Option

Define, by dimension, how the elements of the signal are to be indexed. From the list, choose:

- Assign all

# Assignment

---

This is the default. No further configuration is required. All elements are assigned.

- Index vector (dialog)

Enables the **Index** column. Enter the index of the element.

- Index vector (port)

No columns are enabled. If the **Initialize output (Y)** parameter is set to Initialize using input port <Y0>, the block initializes the output port Y with the input port Y0.

If the **Initialize output (Y)** parameter is set to Specify size for each dimension in table, enter the width of the block's output signal in the **Output Size** column.

- Starting index (dialog)

Enables the **Index** column. Enter the starting index of the range of elements to be assigned values.

- Starting index (port)

No columns are enabled. If the **Initialize output (Y)** parameter is set to Initialize using input port <Y0>, initializes the output port Y with the input port Y0.

If the **Initialize output (Y)** parameter is set to Specify size for each dimension in table, enter the width of the block's output signal in the **Output Size** column.

The **Index** and **Output Size** columns are displayed as relevant.

## Index

If the **Index Option** is Index vector (dialog), enter the index of each element you are interested in.

If the **Index Option** is Starting index (dialog), enter the starting index of the range of elements to be selected. The number of elements from the starting point is determined by the size of this dimension at U.

## Output Size

Enter the width of the block output signal. If you select Specify size for each dimension in table for the **Initialize output (Y)** parameter, this column is enabled.

## Initialize output (Y)

Specify how to initialize the output signal.

- Initialize using input port <Y0>

The signal at the input port Y0 initializes the output.

- Specify size for each dimension in table

The block requires you to specify the width of the block's output signal in the **Output Size** parameter.

## Action if any output element is not assigned

Specifies whether to produce a warning or error message if you have not assigned all output element. Options include:

- Error
- Warning
- None

## Sample time (-1 for inherited)

Specify the time interval between samples. To inherit the sample time, set this parameter to -1. See "Specifying Sample Time" in the "How Simulink Works" chapter of the Using Simulink documentation.

## Characteristics

Direct Feedthrough	Yes
Sample Time	Specified by Sample time parameter
Scalar Expansion	Yes
Dimensionalized	Yes

# Assignment

---

Multidimensionalized	Yes
Zero Crossing	No

**Purpose** Model behavior of system with play

**Library** Discontinuities

**Description**



The Backlash block implements a system in which a change in input causes an equal change in output. However, when the input changes direction, an initial change in input has no effect on the output. The amount of side-to-side play in the system is referred to as the *deadband*. The deadband is centered about the output. This figure shows the block's initial state, with the default deadband width of 1 and initial output of 0.

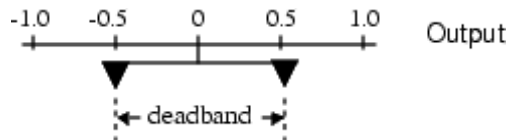

A system with play can be in one of three modes:

- Disengaged - In this mode, the input does not drive the output and the output remains constant.
- Engaged in a positive direction - In this mode, the input is increasing (has a positive slope) and the output is equal to the input *minus* half the deadband width.
- Engaged in a negative direction - In this mode, the input is decreasing (has a negative slope) and the output is equal to the input *plus* half the deadband width.

If the initial input is outside the deadband, the **Initial output** parameter value determines whether the block is engaged in a positive or negative direction, and the output at the start of the simulation is the input plus or minus half the deadband width.

For example, the Backlash block can be used to model the meshing of two gears. The input and output are both shafts with a gear on one end, and the output shaft is driven by the input shaft. Extra space

# Backlash

between the gear teeth introduces *play*. The width of this spacing is the **Deadband width** parameter. If the system is disengaged initially, the output (the position of the driven gear) is defined by the **Initial output** parameter.

The following figures illustrate the block's operation when the initial input is within the deadband. The first figure shows the relationship between the input and the output while the system is in disengaged mode (and the default parameter values are not changed).

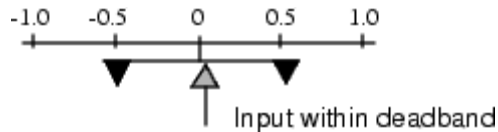

The next figure shows the state of the block when the input has reached the end of the deadband and engaged the output. The output remains at its previous value.

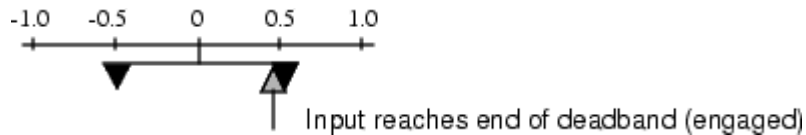

The final figure shows how a change in input affects the output while they are engaged.

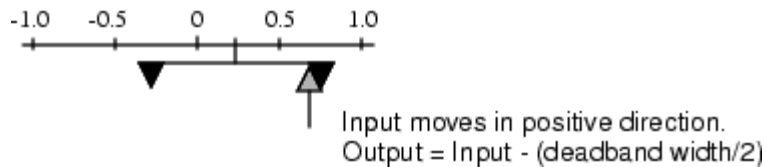

If the input reverses its direction, it disengages from the output. The output remains constant until the input either reaches the opposite end of the deadband or reverses its direction again and engages at the same end of the deadband. Now, as before, movement in the input causes equal movement in the output.

For example, if the deadband width is 2 and the initial output is 5, the output,  $y$ , at the start of the simulation is as follows:

- 5 if the input,  $u$ , is between 4 and 6
- $u + 1$  if  $u < 4$
- $u - 1$  if  $u > 6$

This sample model and the plot that follows it show the effect of a sine wave passing through a Backlash block.

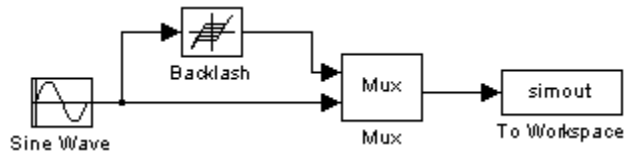

The Backlash block parameters are unchanged from their default values (the deadband width is 1 and the initial output is 0). Notice in the plotted output following that the Backlash block output is zero until the input reaches the end of the deadband (at 0.5). Now the input and output are engaged and the output moves as the input does until the input changes direction (at 1.0). When the input reaches 0, it again engages the output at the opposite end of the deadband.

# Backlash

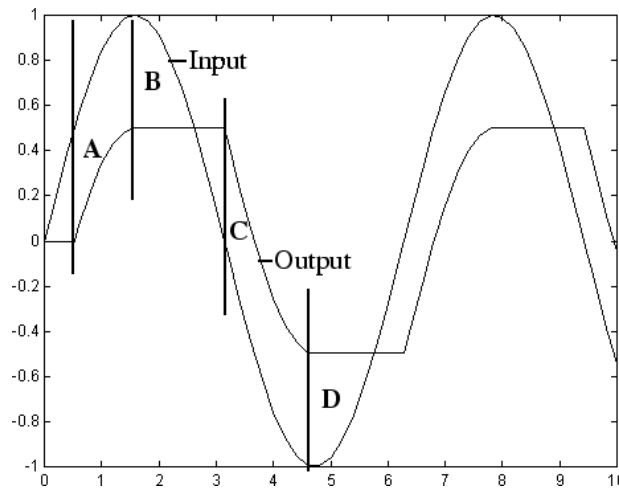

## Data Type Support

The Backlash block accepts and outputs real values of single, double, and built-in integer data types.

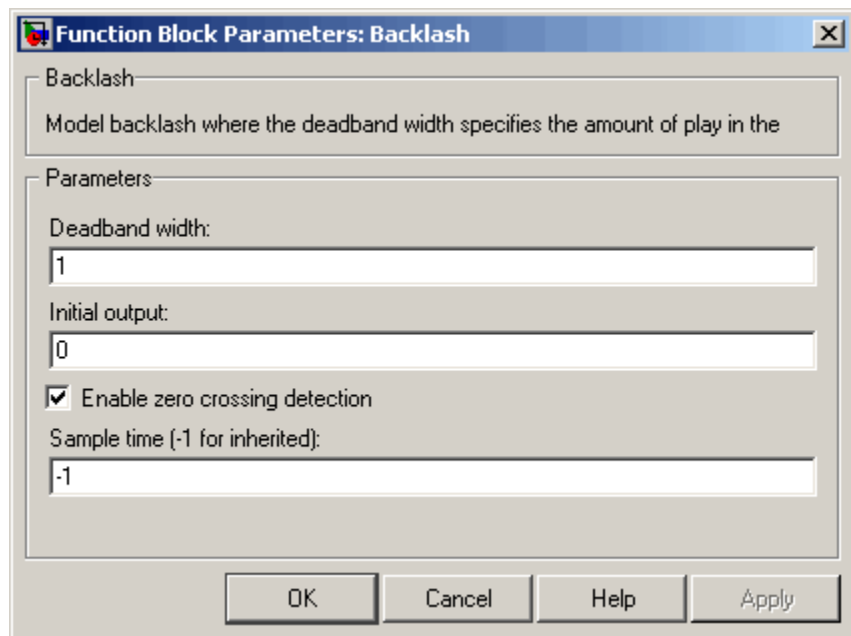

**Parameters  
and  
Dialog  
Box****Deadband width**

Specify the width of the deadband. The default is 1.

**Initial output**

Specify the initial output value. The default value is 0. This parameter is tunable. Simulink does not allow the initial output of this block to be  $\infty$  or NaN.

**Enable zero-crossing detection**

Select to enable use of zero-crossing detection to detect engagement with lower and upper thresholds. For more information, see “Zero-Crossing Detection” in the “How Simulink Works” chapter of the Using Simulink documentation.

**Sample time (-1 for inherited)**

Specify the time interval between samples. To inherit the sample time, set this parameter to -1. See “Specifying Sample Time”

# Backlash

---

in the “How Simulink Works” chapter of the Using Simulink documentation.

## Characteristics

Direct Feedthrough	Yes
Sample Time	Specified in the <b>Sample time</b> parameter
Scalar Expansion	Yes
Dimensionalized	Yes
Zero Crossing	Yes, if you select <b>Enable zero crossing detection</b>

## Purpose

Indicate unresolved reference to library block

## Description

This block indicates an unresolved reference to a library block (see “Creating a Library Link”). You can use this block’s parameter dialog box to fix the reference to point to the actual location of the library block.

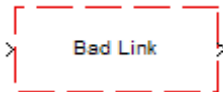

## Parameters and Dialog Box

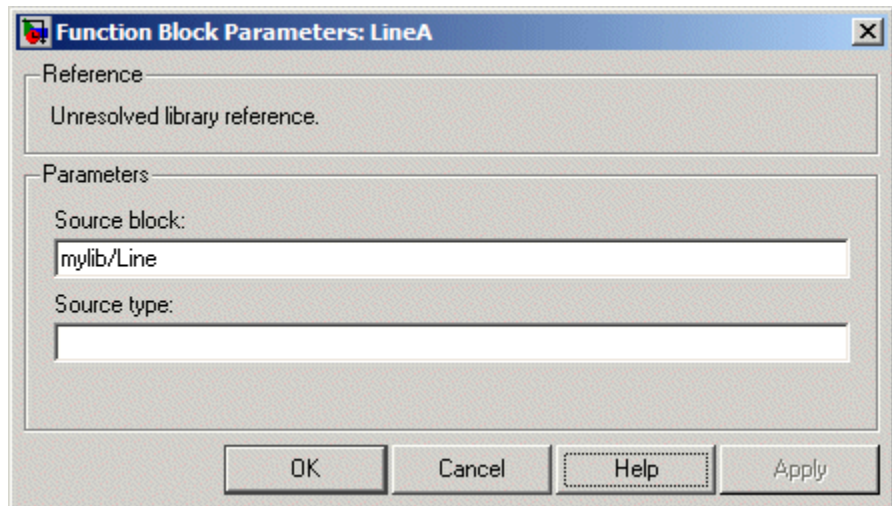

### Source block

Path of the library block that this link represents. To fix a bad link, edit this field to reflect the actual path of the library block. Then select Apply or OK to apply the fix and close the dialog box.

### Source type

Type of library block that this link represents.

# Band-Limited White Noise

---

**Purpose** Introduce white noise into continuous system

**Library** Sources

## Description



The Band-Limited White Noise block generates normally distributed random numbers that are suitable for use in continuous or hybrid systems.

The primary difference between this block and the Random Number block is that the Band-Limited White Noise block produces output at a specific sample rate, which is related to the correlation time of the noise.

Theoretically, continuous white noise has a correlation time of 0, a flat power spectral density (PSD), and a covariance of infinity. In practice, physical systems are never disturbed by white noise, although white noise is a useful theoretical approximation when the noise disturbance has a correlation time that is very small relative to the natural bandwidth of the system.

In Simulink, you can simulate the effect of white noise by using a random sequence with a correlation time much smaller than the shortest time constant of the system. The Band-Limited White Noise block produces such a sequence. The correlation time of the noise is the sample rate of the block. For accurate simulations, use a correlation time much smaller than the fastest dynamics of the system. You can get good results by specifying

$$t_c \approx \frac{1}{100 f_{\max}} \frac{2\pi}{\text{rad/sec}}$$

where  $f_{\max}$  is the bandwidth of the system in rad/sec.

## The Algorithm Used in the Block Implementation

To produce the correct intensity of this noise, the covariance of the noise is scaled to reflect the implicit conversion from a continuous PSD to a discrete noise covariance. The appropriate scale factor is  $1/tc$ , where  $tc$  is the correlation time of the noise. This scaling ensures that the response of a continuous system to the approximate white noise has the same covariance as the system would have to true white noise. Because

of this scaling, the covariance of the signal from the Band-Limited White Noise block is not the same as the **Noise power** (intensity) dialog box parameter. This parameter is actually the height of the PSD of the white noise. While the covariance of true white noise is infinite, the approximation used in this block has the property that the covariance of the block output is the **Noise Power** divided by  $tc$ .

## Data Type Support

The Band-Limited White Noise block outputs real values of type double.

## Parameters and Dialog Box

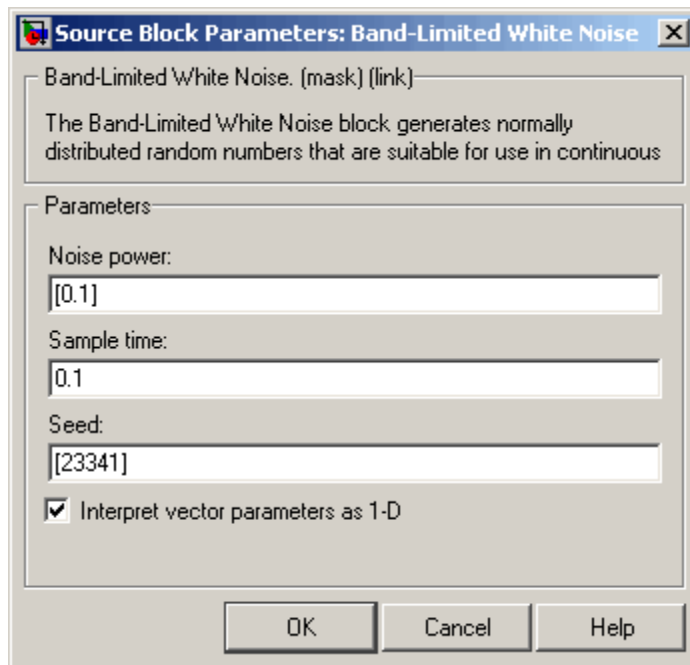

Opening this dialog box causes a running simulation to pause. See “Changing Source Block Parameters During Simulation” in the “Working with Blocks” chapter of the Using Simulink documentation.

# Band-Limited White Noise

---

## Noise power

The height of the PSD of the white noise. The default value is 0.1.

## Sample time

The correlation time of the noise. The default value is 0.1. See “Specifying Sample Time” in the “How Simulink Works” chapter of the Using Simulink documentation.

## Seed

The starting seed for the random number generator. The default value is 23341.

## Interpret vector parameters as 1-D

Output a 1-D array if the block’s parameters are vectors. Otherwise, output a 2-D array one of whose dimensions is 1. See “Determining the Output Dimensions of Source Blocks” in the “Working with Signals” chapter of the Using Simulink documentation.

## Characteristics

Sample Time	Specified in the <b>Sample time</b> parameter
Scalar Expansion	Yes, of <b>Noise power</b> and <b>Seed</b> parameters and output
Dimensionalized	Yes
Zero Crossing	No

**Purpose** Add bias to input

**Library** Math Operations

**Description** The Bias block adds a bias, or offset, to the input signal according to

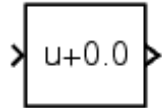

$$Y = U + Bias$$

where  $U$  is the block input and  $Y$  is the output.

### Data Type Support

The Bias block accepts and outputs real or complex values of any data type supported by Simulink, except Boolean. The Bias block supports fixed-point data types.

For a discussion on the data types supported by Simulink, see “Data Types Supported by Simulink” in the “Working with Data” chapter of the Using Simulink documentation.

### Parameters and Dialog Box

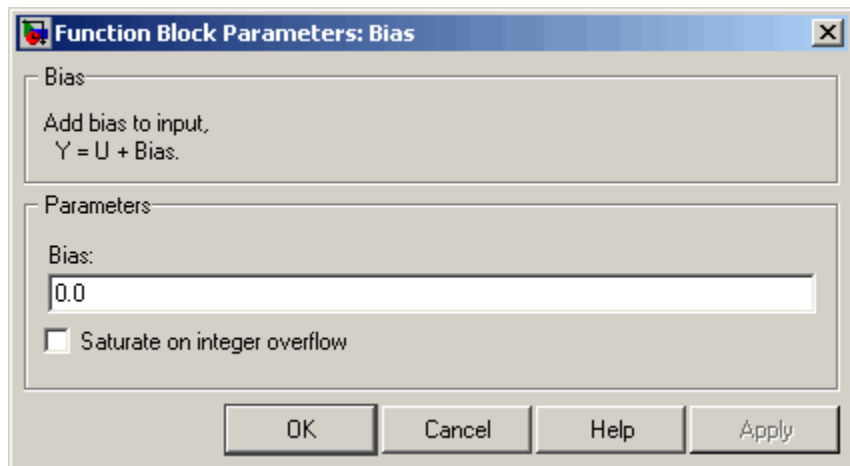

### Bias

Specify the value of the offset to add to the input signal.

## Saturate on integer overflow

If the input (and hence the output) is an integer data type (for example, `int8`) and the data type cannot accommodate the output signal, selecting this option causes the block to output the maximum value allowed by the data type. Otherwise, in this case, the block outputs the result of using twos-complement arithmetic to add the input to the output, i.e., the value is the result of adding the bias to the input modulo the maximum representable value of the data type.

## Characteristics

Direct Feedthrough	Yes
Sample Time	Inherited from the driving block
Scalar Expansion	Yes
States	0
Dimensionalized	Yes
Zero Crossing	No



**Purpose** Set specified bit of stored integer to zero

**Library** Logic and Bit Operations

**Description** The Bit Clear block sets the specified bit, given by its index, of the stored integer to zero. Scaling is ignored.



You can specify the bit to be set to zero with the **Index of bit** parameter, where bit zero is the least significant bit.

**Data Type Support** The Bit Clear block supports Simulink integer, fixed-point, and Boolean data types. True floating-point data types are not supported.

## Parameters and Dialog Box

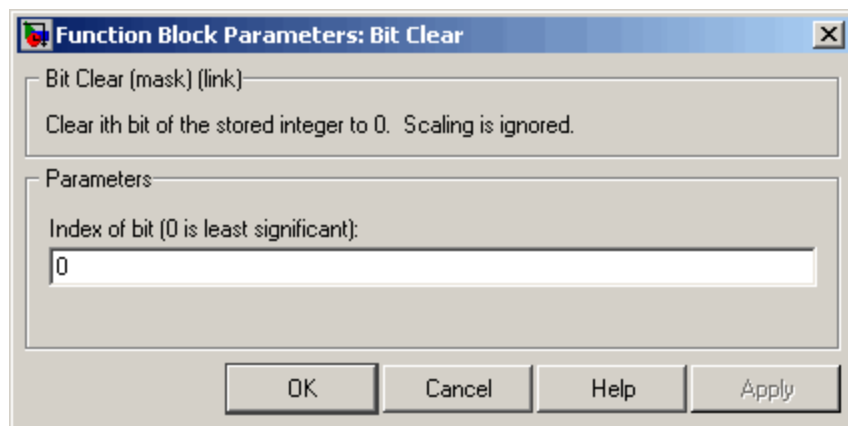

### Index of bit

Index of bit where bit 0 is the least significant bit.

## Examples

If the Bit Clear block is turned on for bit 2, bit 2 is set to 0. A vector of constants  $2.^{[0\ 1\ 2\ 3\ 4]}$  is represented in binary as [00001 00010 00100 01000 10000]. With bit 2 set to 0, the result is [00001 00010 00000 01000 10000], which is represented in decimal as [1 2 0 8 16].

# Bit Clear

---

<b>Characteristics</b>	Direct Feedthrough	Yes
	Scalar Expansion	Yes

**See Also**      Bit Set

**Purpose** Set specified bit of stored integer to one

**Library** Logic and Bit Operations

**Description** The Bit Set block sets the specified bit of the stored integer to one. Scaling is ignored.



You can specify the bit to be set to one with the **Index of bit** parameter, where bit zero is the least significant bit.

**Data Type Support** The Bit Set block supports Simulink integer, fixed-point, and Boolean data types. True floating-point data types are not supported.

## Parameters and Dialog Box

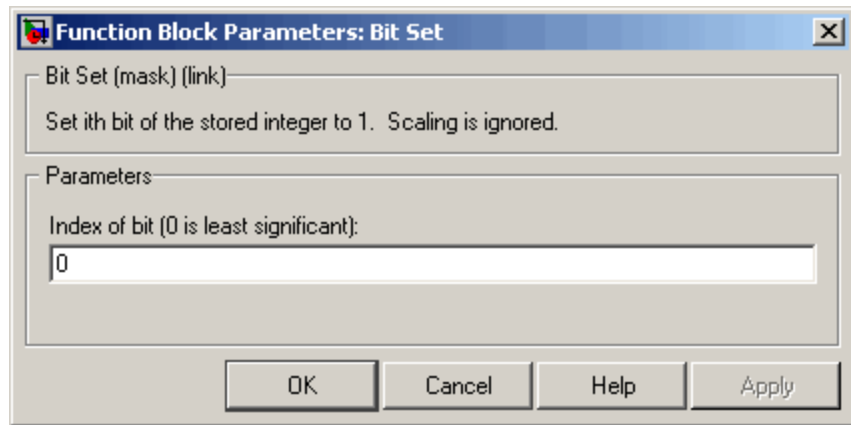

### Index of bit

Index of bit where bit 0 is the least significant bit.

**Examples** If the Bit Set block is turned on for bit 2, bit 2 is set to 1. A vector of constants  $2.^{[0\ 1\ 2\ 3\ 4]}$  is represented in binary as [00001 00010 00100 01000 10000]. With bit 2 set to 1, the result is [00101 00110 00100 01100 10100], which is represented in decimal as [5 6 4 12 20].

# Bit Set

---

<b>Characteristics</b>	Direct Feedthrough	Yes
	Scalar Expansion	Yes

**See Also**      Bit Clear

**Purpose** Perform specified bitwise operation on inputs

**Library** Logic and Bit Operations

**Description** The Bitwise Operator block performs the specified bitwise operation on its operands.

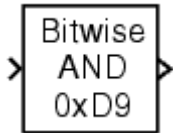

Unlike the logic operations performed by the Logical Operator block, bitwise operations treat the operands as a vector of bits rather than a single number. You select the bitwise Boolean operation from the **Operator** parameter list. The supported operations are given below.

Operation	Description
AND	TRUE if the corresponding bits are all TRUE
OR	TRUE if at least one of the corresponding bits is TRUE
NAND	TRUE if at least one of the corresponding bits is FALSE
NOR	TRUE if no corresponding bits are TRUE
XOR	TRUE if an odd number of corresponding bits are TRUE
NOT	TRUE if the input is FALSE (available only for single input)

The Bitwise Operator block does not support shift operations. For shift operations, see the Shift Arithmetic block.

The size of the output of the Bitwise Operator block depends on the number of inputs, their vector size, and the selected operator:

- The NOT operator accepts only one input, which can be a scalar or a vector. If the input is a vector, the output is a vector of the same size containing the bitwise logical complements of the input vector elements.

# Bitwise Operator

---

- For a single vector input, the block applies the operation (except the NOT operator) to all elements of the vector. If a bit mask is not specified, then the output is a scalar. If a bit mask is specified, then the output is a vector.
- For two or more inputs, the block performs the operation between all of the inputs. If the inputs are vectors, the operation is performed between corresponding elements of the vectors to produce a vector output.

When configured as a multi-input XOR gate, this block performs an addition- modulo-two operation as mandated by the IEEE Standard for Logic Elements.

If you do not select the **Use bit mask** check box, then the block can accept multiple inputs. You select the number of input ports from the **Number of input ports** parameter. The input data types must be identical.

If you select the **Use bit mask** check box, then a single input is associated with the bit mask you specify from the **Bit Mask** parameter. You specify the bit mask using any valid MATLAB expression. For example, you can specify the bit mask 00100101 as  $2^5+2^2+2^0$ . Alternatively, you can use strings to specify a hexadecimal bit mask such as {'FE73', '12AC'}. If the bit mask is larger than the input signal data type, then it is ignored.

---

**Note** The output data type, which is inherited from the driving block, should represent zero exactly. Data types that satisfy this condition include signed and unsigned integers and any floating-point data type.

---

The **Treat mask as** parameter list controls how the mask is treated. The possible values are Real World Value and Stored Integer. In terms of the general encoding scheme described in the “Scaling” section of the Simulink Fixed Point documentation, Real World Value treats

the mask as  $V = SQ + B$  where  $S$  is the slope and  $B$  is the bias. Stored Integer treats the mask as a stored integer,  $Q$ .

You can use the bit mask to perform a bit set or a bit clear on the input. To perform a bit set, set the **Operator** parameter list to OR and create a bit mask with a 1 for each corresponding input bit that you want to set to 1. To perform a bit clear, set the **Operator** parameter list to AND and create a bit mask with a 0 for each corresponding input bit that you want to set to 0.

For example, suppose you want to perform a bit set on the fourth bit of an 8-bit input vector. The bit mask would be 00010000, which you can specify as  $2^4$  in the **Bit mask** parameter. To perform a bit clear, the bit mask would be 11101111, which you can specify as  $2^7+2^6+2^5+2^3+2^2+2^1+2^0$  in the **Bit mask** parameter.

## Data Type Support

The Bitwise Operator block supports Simulink integer, fixed-point, and Boolean data types. The block does not support true floating-point data types.

# Bitwise Operator

## Parameters and Dialog Box

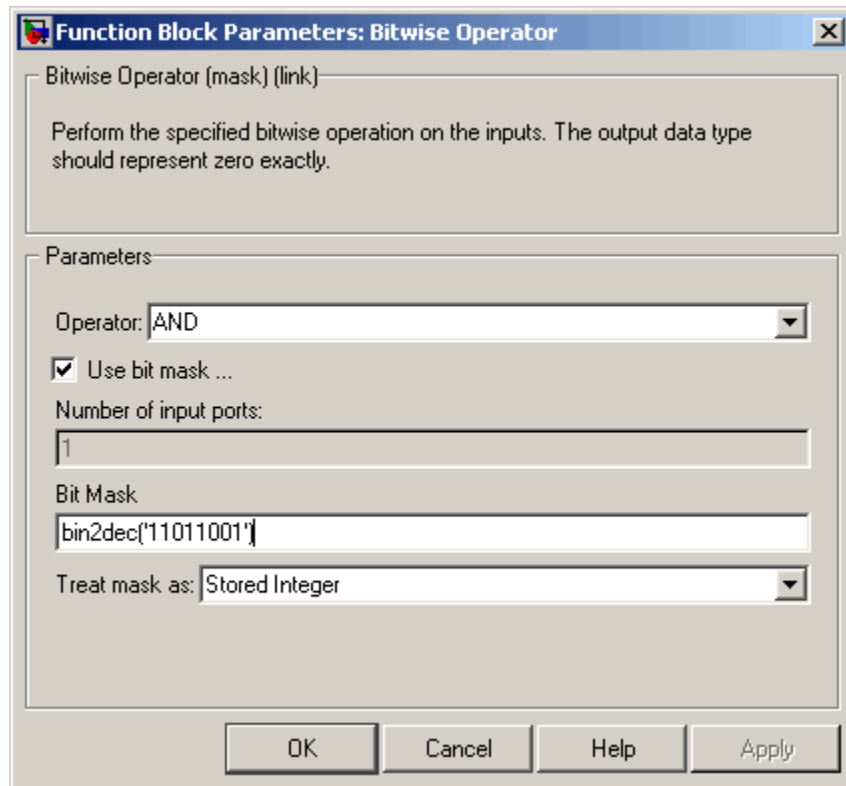

### Operator

The bitwise logical operator associated with the specified operands.

### Use bit mask

Specify if the bit mask is used (single input only).

### Number of input ports

The number of inputs.



## Bit Mask

The bit mask to associate with a single input. The **Bit Mask** parameter is converted from a double to the input data type offline using round-to-nearest and saturation.

## Treat mask as

Treat the mask as a real-world value or as a stored integer.

## Examples

To help you understand the Bitwise Operator block logic operations, consider the fixed-point model shown below.

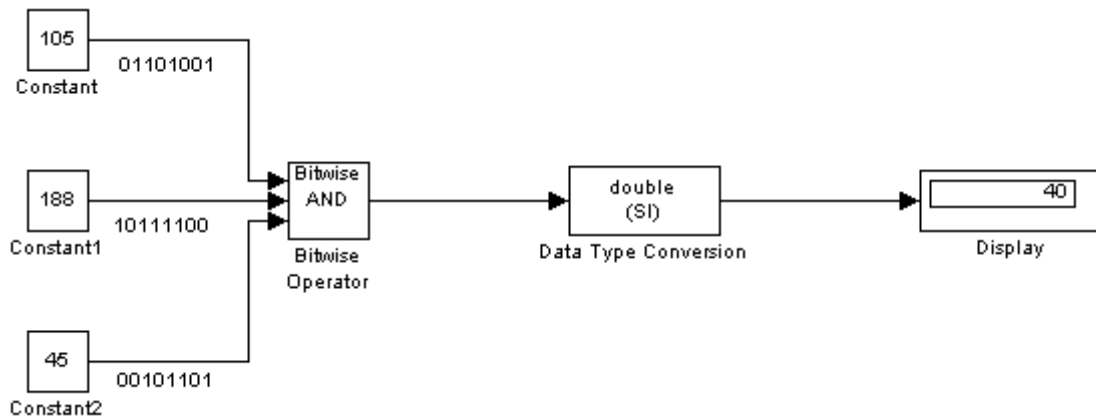

The Constant blocks are configured to output an 8-bit unsigned integer (uint(8)). The results for all logic operations are shown below.

Operation	Binary Value	Decimal Value
AND	00101000	40
OR	11111101	253
NAND	11010111	215
NOR	00000010	2

# Bitwise Operator

---

Operation	Binary Value	Decimal Value
XOR	11111000	248
NOT	N/A	N/A

## Characteristics

Direct Feedthrough	No
Scalar Expansion	Yes, of inputs
Multidimensionalized	Yes

**Purpose** View data type support for Simulink blocks

**Library** Model-Wide Utilities

**Description** The Block Support Table block enables you to access a table that summarizes the data types supported by the blocks in the Simulink libraries. Double-click the block to view the table.



**Data Type Support** Not applicable.

**Parameters and Dialog Box**

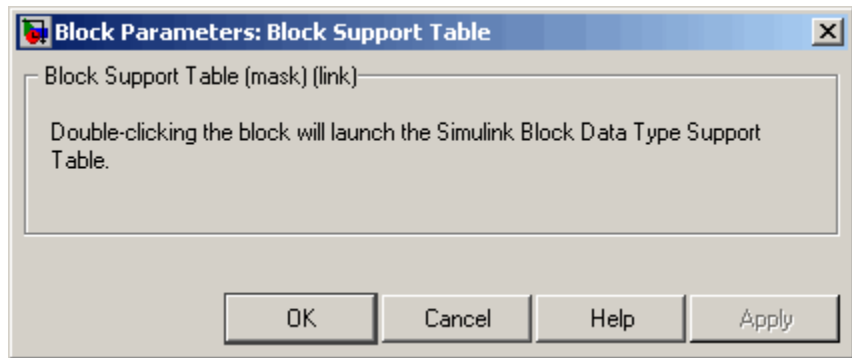

**Characteristics** Not applicable.

# Bus Assignment

---

**Purpose** Assign values to specified elements of bus

**Library** Signal Routing

## Description

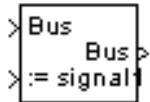

The Bus Assignment block assigns values, specified by signals connected to its assignment (`:=`) input ports, to specified elements of the bus connected to its Bus input port. Use the block's dialog box to specify the bus elements to be assigned values. The block displays an assignment input port for each bus element to be assigned a signal. The signal connected to the assignment port must have the same structure (i.e., vector, matrix, bus), data type, and numeric (i.e., real or complex) type as the bus element to which it corresponds.

---

**Note** If an associated bus object (see `Bus Creator` and `Simulink.Bus`) defines the bus to be assigned values, all of the assignment signals must have the same sample time, even if the elements of the bus object associated with the bus specify inherited sample times.

---

## Data Type Support

The bus input port of the Bus Assignment block accepts and outputs real or complex values of any data type supported by Simulink, including fixed-point data types. The assignment input ports accept the same data and numeric types as the bus elements to which they correspond.

For a discussion on the data types supported by Simulink, see “Data Types Supported by Simulink” in the “Working with Data” chapter of the Using Simulink documentation.

## Parameters and Dialog Box

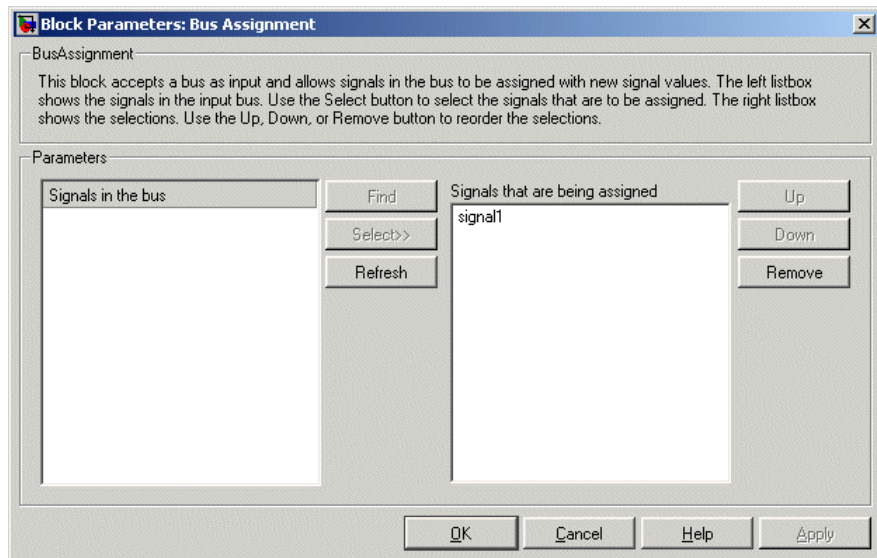

### Signals in the bus

Displays the names of the signals contained by the bus at the block's Bus input port. Click any item in the list to select it. To find the source of the selected signal, click the adjacent **Find** button. Simulink opens the subsystem containing the signal source, if necessary, and highlights the source's icon. Use the **Select>>** button to move the currently selected signal into the adjacent list of signals to be assigned values (see **Signals that are being assigned** below). To refresh the display (e.g., to reflect modifications to the bus connected to the block), click the adjacent **Refresh** button.

### Signals that are being assigned

Lists the names of bus elements to be assigned values. This block displays an assignment input port for each bus element in this list. The label of the corresponding input port contains the name of the element. You can order the signals by using the **Up**, **Down**, and **Remove** buttons. Port connectivity is maintained when the signal order is changed.

# Bus Assignment

---

Three question marks (???) before the name of a bus element indicate that the input bus no longer contains an element of that name, for example, because the bus has changed since the last time you refreshed the Bus Assignment block's input and bus element assignment lists. You can fix the problem either by modifying the bus to include a signal of the specified name or by removing the name from the list of bus elements to be assigned values.

<b>Characteristics</b>	Multidimensionalized	Yes
------------------------	----------------------	-----

**Purpose** Create signal bus

**Library** Signal Routing

## Description



The Bus Creator block combines a set of signals into a bus, i.e., a group of signals represented by a single line in a block diagram. The Bus Creator block, when used in conjunction with the Bus Selector block, allows you to reduce the number of lines required to route signals from one part of a diagram to another. This makes your diagram easier to understand.

To bundle a group of signals with a Bus Creator block, set the block's **Number of inputs** parameter to the number of signals in the group. The block displays the number of ports that you specify. Connect the signals to be grouped to the resulting input ports. The signals in the bus will be order from the top input port to the bottom input port. See “Changing the Orientation of a Block” in Using Simulink for a description of the port order for various block orientations.

You can connect any type of signal to the inputs, including other bus signals. To ungroup the signals, connect the block's output port to a Bus Selector port.

---

**Note** Simulink hides the name of a Bus Creator block when you copy it from the Simulink library to a model.

---

## Naming Signals

The Bus Creator block assigns a name to each signal on the bus that it creates. This allows you to refer to signals by name when searching for their sources (see “Browsing Bus Signals” on page 2-51) or selecting signals for connection to other blocks. The block offers two bus signal naming options. You can specify that each signal on the bus inherit the name of the signal connected to the bus (the default) or that each input signal must have a specific name.

# Bus Creator

To specify that bus signals inherit their names from input ports, select **Inherit bus signal names from input ports** from the list box on the block's parameter dialog box. The names of the inherited bus signals appear in the **Signals in bus** list box.

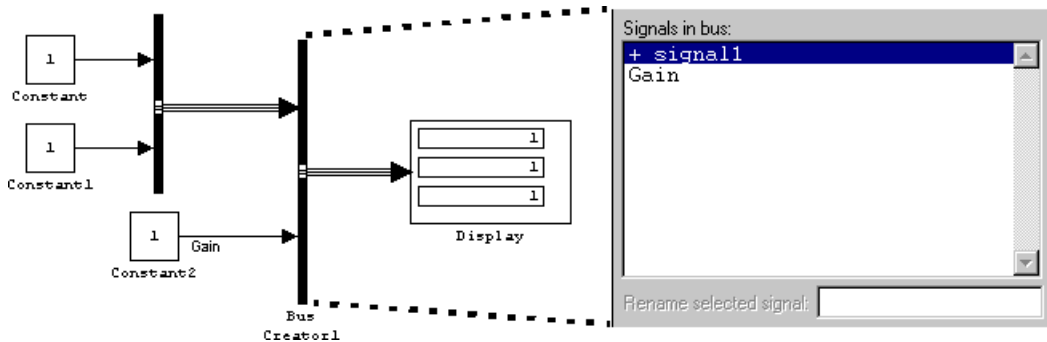

The Bus Creator block generates names for bus signals whose corresponding inputs do not have names. The names are of the form `signaln`, where `n` is the number of the port to which the input signal is connected.

You can change the name of any signal by editing its name on the block diagram or in the **Signal Properties** dialog box. If you change a name in this way while the Bus Creator block's dialog box is open, you must close and reopen the dialog box or click the **Refresh** button next to the **Signals in bus** list to update the name in the dialog box.

To specify that the bus inputs must have specific names, select **Require input signal names to match signals below** from the list box in the block's parameter dialog box. The block's parameter dialog box displays the names of the signals currently connected to its inputs, or a generated name (for example, `signal2`) for an anonymous input. You can now use the parameter dialog box to change the required names of the block's inputs.

To change the required signal name, select the signal in the **Signals in bus** list. The selected signal's name appears in the **Rename selected signal** field. Edit the name in the field and click **Apply** or **OK**.



## Browsing Bus Signals

The **Signals in bus** list on a Bus Creator block's parameter dialog box displays a list of the signals entering the block. A plus sign (+) next to a signal indicates that the signal is itself a bus. You can display its contents by clicking the plus sign. If the expanded input includes bus signals, plus signs appear next to the names of those bus signals. You can expand them as well. In this way, you can view all signals entering the block, including those entering via buses. To find the source of any signal entering the block, select the signal in the **Signals in bus** list and click the adjacent **Find** button. Simulink opens the subsystem containing the signal source, if necessary, and highlights the source's icon.

## Data Type Support

The Bus Creator block accepts and outputs real or complex values of any data type supported by Simulink, including fixed-point data types.

For a discussion on the data types supported by Simulink, refer to “Data Types Supported by Simulink” in the “Working with Data” chapter of the Using Simulink documentation.

# Bus Creator

## Parameters and Dialog Box

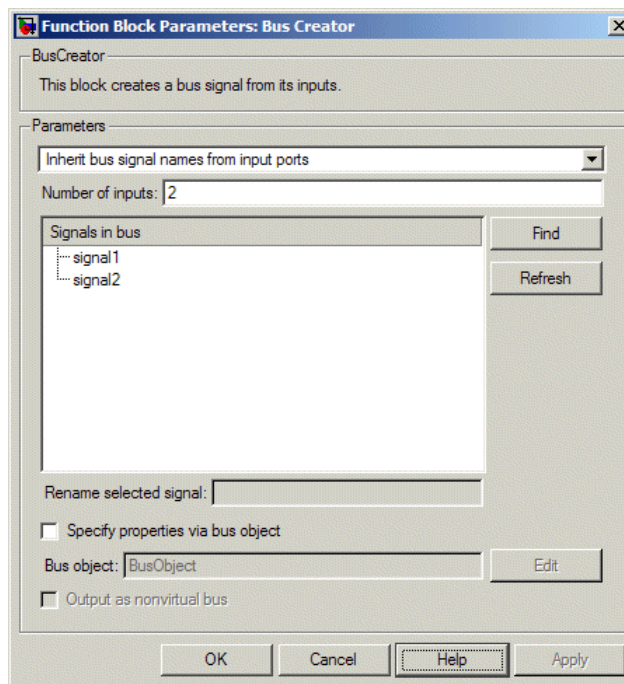

### Signal naming options

Select **Inherit bus signal names from input ports** to assign input signal names to the corresponding bus signals. Select **Require input signal names to match signals below** to specify that inputs must have the names listed in the **Signals in bus** list. Selecting this option enables the **Rename selected signal** field.

### Number of inputs

Specifies the number of input ports on this block.

### Signals in bus

The **Signals in bus list box** shows the signals in the output bus. A plus sign (+) next to a signal name indicates that the signal is itself a bus. Click the plus sign to display the subsidiary bus

signals. Click the **Refresh** button to update the list after editing the name of an input signal. Click the **Find** button to highlight the source of the currently selected signal.

### **Rename selected signal**

Lists the name of the signal currently selected in the **Signals in bus** list when you select the **Require input signal names to match signals below** option. Edit this field to change the name of the currently selected signal.

### **Specify properties via bus object**

Select this option to use a bus object to define the structure of the bus created by this block (see “Working with Data Objects” in the “Working with Data” chapter of the Using Simulink documentation and the `Simulink.Bus` class in the online Simulink reference to learn how to create bus objects).

### **Bus object**

This option is enabled only if you select the **Specify properties via bus object** option. It specifies the name of bus object used to define the structure of the bus created by this block. At the beginning of a simulation or when you update the model’s diagram, Simulink checks whether the signals connected to this Bus Creator block have the specified structure. If not, Simulink displays an error message.

---

**Note** If you select this option, all of the signals entering the Bus Creator block must have the same sample time, even if the elements of the associated bus object specify inherited sample times.

---

### **Output as nonvirtual bus**

This option is enabled only if you select the **Specify properties via bus object** option. If this option is selected, this block outputs a nonvirtual bus; otherwise, it outputs a virtual bus (see “Virtual and Nonvirtual Buses” in the “Working with Signals” chapter of

# Bus Creator

---

the Using Simulink documentation). Select this option if you want code generated from this model to use a C structure to define the structure of the bus signal output by this block.

<b>Characteristics</b>	Multidimensionalized	Yes
------------------------	----------------------	-----

**Purpose** Select signals from incoming bus

**Library** Signal Routing

**Description**



The Bus Selector block outputs a specified subset of the elements of the bus at its input. The block can output the selected elements as multiple standalone signals or as elements of a new bus. When selecting elements from the bus, each element is output from a separate port from top to bottom on the block. (See “Changing the Orientation of a Block” in Using Simulink for a description of the port order for various block orientations.)

---

**Note** Simulink hides the name of a Bus Selector block when you copy it from the Simulink library to a model.

---

**Data Type Support**

A Bus Selector block accepts and outputs real or complex values of any data type supported by Simulink, including fixed-point data types.

For a discussion on the data types supported by Simulink, see “Data Types Supported by Simulink” in the “Working with Data” chapter of the Using Simulink documentation.

# Bus Selector

## Parameters and Dialog Box

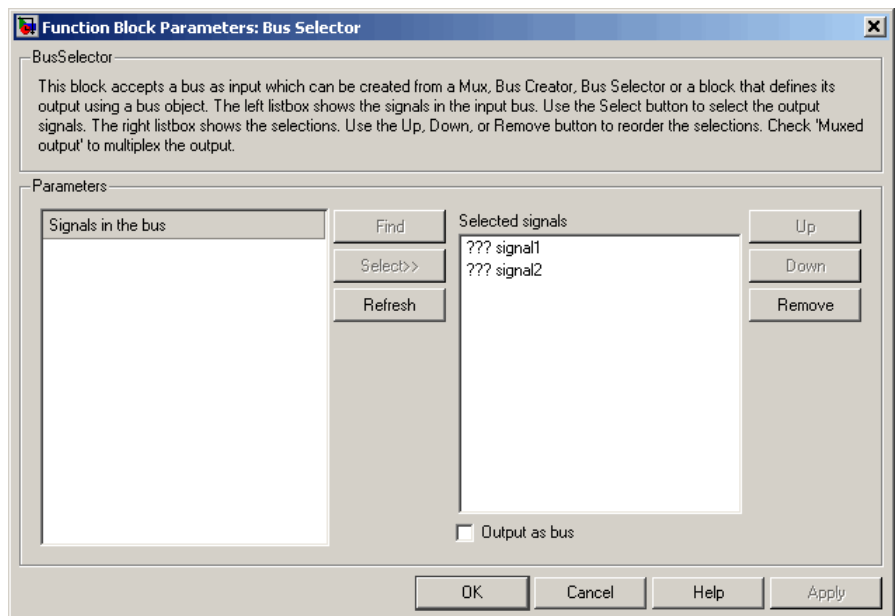

### Signals in the bus

The **Signals in the bus** list shows the signals in the input bus. Use the **Select>>** button to select output signals. To find the source of any signal entering the block, select the signal in the **Signals in the bus** list and click the adjacent **Find** button. Simulink opens the subsystem containing the signal source, if necessary, and highlights the source's icon. To refresh the display (e.g., to reflect modifications to the bus connected to the block), click the adjacent **Refresh** button.

### Selected signals

The **Selected signals** list box shows the output signals. You can order the signals by using the **Up**, **Down**, and **Remove** buttons. Port connectivity is maintained when the signal order is changed.

If an output signal listed in the **Selected signals** list box is not an input to the Bus Selector block, the signal name is preceded by three question marks (???).

### **Output as bus**

If selected, this option causes the block to output the selected elements as a bus. Otherwise, the block outputs the elements as standalone signals, each from its own output port and labeled with the corresponding element's name.

<b>Characteristics</b>	Multidimensionalized	Yes

# Bus to Vector

---

**Purpose** Convert virtual bus to vector

**Library** Signal Attributes

## Description



The Bus to Vector block converts a virtual bus signal to a vector signal. The input bus signal must consist of scalar, 1-D, or either row or column vectors having the same data type, signal type, and sampling mode. If the input bus contains row or column vectors, this block outputs a row or column vector, respectively; otherwise, it outputs a 1-D array.

Use the Bus to Vector block only to replace an implicit bus-to-vector conversion with an equivalent explicit conversion. See “Bus signal treated as vector” and “Correcting Buses Used as Muxes” for more information.

---

**Note** Simulink hides the name of a Bus to Vector block when you copy it from the Simulink library to a model.

---

## Data Type Support

The Bus to Vector block accepts and outputs real or complex values of any data type supported by Simulink, including fixed-point data types.

For a discussion of the data types supported by Simulink, refer to “Data Types Supported by Simulink” in the “Working with Data” chapter of the Simulink documentation.



## Parameters and Dialog Box

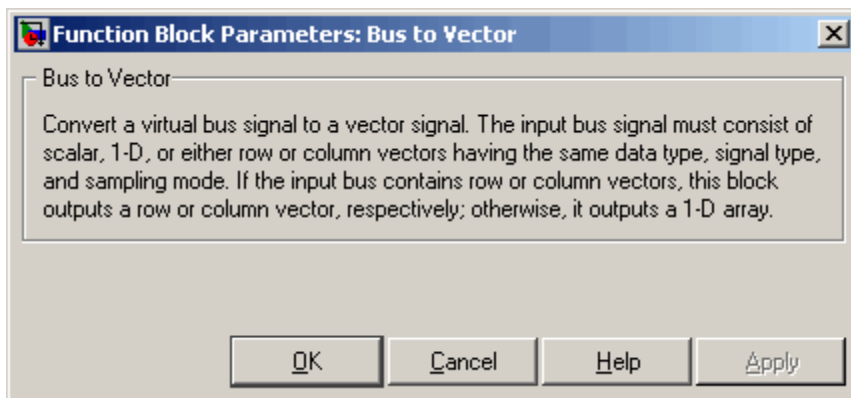

This block has no user-accessible parameters.

## Characteristics

Multidimensionalized	Yes
----------------------	-----

# Check Discrete Gradient

---

## Purpose

Check that absolute value of difference between successive samples of discrete signal is less than upper bound

## Library

Model Verification

## Description

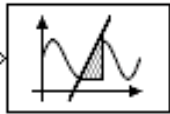

The Check Discrete Gradient block checks each signal element at its input to determine whether the absolute value of the difference between successive samples of the element is less than an upper bound. The block's parameter dialog box allows you to specify the value of the upper bound (1 by default). If the verification condition is true, the block does nothing. Otherwise, the block halts the simulation, by default, and displays an error message in the Simulation Diagnostics Viewer.

The **Model Verification block enabling** setting under **Debugging** on the **Data Validity** diagnostics pane of the **Configuration Parameters** dialog box lets you enable or disable all model verification blocks, including Check Discrete Gradient blocks, in a model.

The Check Discrete Gradient block and its companion blocks in the Model Verification library are intended to facilitate creation of self-validating models. For example, you can use model verification blocks to test that signals do not exceed specified limits during simulation. When you are satisfied that a model is correct, you can turn error checking off by disabling the verification blocks. You do not have to physically remove them from the model. If you need to modify a model, you can temporarily turn the verification blocks back on to ensure that your changes do not break the model.

## Data Type Support

The Check Discrete Gradient block accepts single, double, int8, int16, and int32 input signals of any dimensions.

## Parameters and Dialog Box

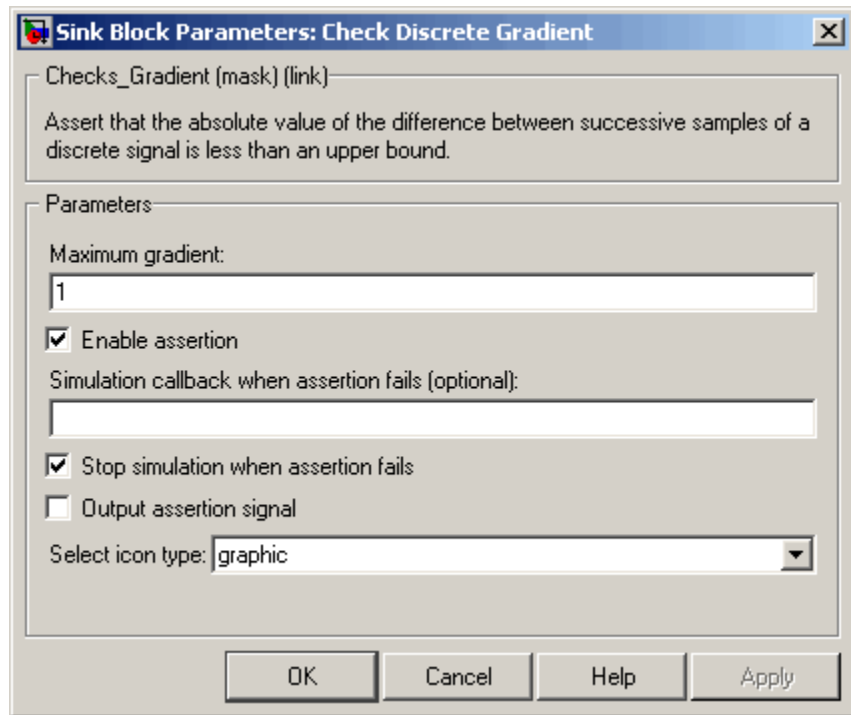

### Maximum gradient

Upper bound on the gradient of the discrete input signal.

### Enable assertion

Unchecking this option disables the Check Discrete Gradient block, that is, causes the model to behave as if the block did not exist. The **Model Verification block enabling** setting under **Debugging** on the **Data Validity** diagnostics pane of the **Configuration Parameters** dialog box allows you to enable or disable all model verification blocks in a model, including Check Discrete Gradient blocks, regardless of the setting of this option.

### Simulation callback when assertion fails

An M-expression to be evaluated when the assertion fails.

# Check Discrete Gradient

---

## Stop simulation when assertion fails

If checked, this option causes the Check Discrete Gradient block to halt the simulation when the block's output is zero and display an error message in Simulink's **Simulation Diagnostics** viewer. Otherwise, the block displays a warning message in the MATLAB Command Window and continues the simulation.

## Output assertion signal

If checked, this option causes the Check Discrete Gradient block to output a Boolean signal that is true (1) at each time step if the assertion succeeds and false (0) if the assertion fails. The data type of the output signal is Boolean if you have selected the Implement logic signals as boolean data option on the **Simulation and code generation** optimization pane of Simulink's **Configuration Parameters** dialog box. Otherwise the data type of the output signal is double.

## Select icon type

Type of icon used to display this block in a block diagram: either graphic or text. The graphic option displays a graphical representation of the assertion condition on the icon. The text option displays a mathematical expression that represents the assertion condition. If the icon is too small to display the expression, the text icon displays an exclamation point. To see the expression, enlarge the block.

## Characteristics

Direct Feedthrough	No
Sample Time	Inherited from driving block
Scalar Expansion	No
Dimensionalized	Yes
Zero Crossing	No

## Purpose

Check that gap of possibly varying width occurs in range of signal's amplitudes

## Library

Model Verification

## Description

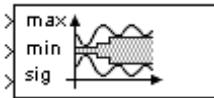

The Check Dynamic Gap block checks that a gap of possibly varying width occurs in the range of a signal's amplitudes. The test signal is the signal connected to the input labeled *sig*. The inputs labeled *min* and *max* specify the lower and upper bounds of the dynamic gap, respectively. If the verification condition is true, the block does nothing. If not, the block halts the simulation, by default, and displays an error message.

The Check Dynamic Gap block and its companion blocks in the Model Verification library are intended to facilitate creation of self-validating models. For example, you can use model verification blocks to test that signals do not exceed specified limits during simulation. When you are satisfied that a model is correct, you can turn error checking off by disabling the verification blocks. You do not have to physically remove them from the model. If you need to modify a model, you can temporarily turn the verification blocks back on to ensure that your changes do not break the model.

## Data Type Support

The Check Dynamic Gap block accepts input signals of any dimensions and of any data type supported by Simulink. All three input signals must have the same dimension and data type. If the inputs are nonscalar, the block checks each element of the input test signal to the corresponding elements of the reference signals.

For a discussion on the data types supported by Simulink, see “Data Types Supported by Simulink” in the “Working with Data” chapter of the Using Simulink documentation.

# Check Dynamic Gap

## Parameters and Dialog Box

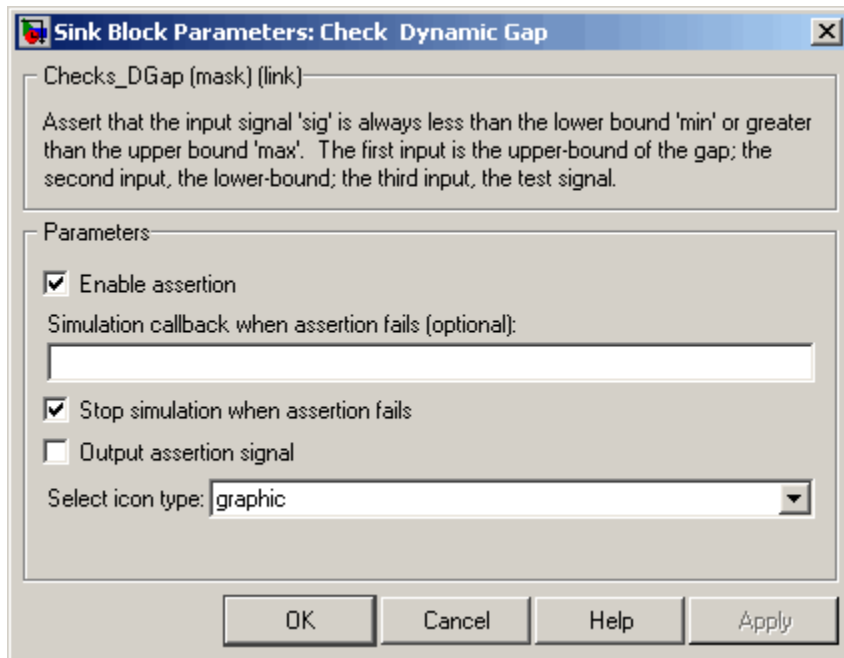

### Enable assertion

Unchecking this option disables the Check Dynamic Gap block, that is, causes the model to behave as if the block did not exist. The **Model Verification block enabling** setting under **Debugging** on the **Data Validity** diagnostics pane of the **Configuration Parameters** dialog box allows you to enable or disable all model verification blocks in a model, including Check Dynamic Gap blocks, regardless of the setting of this option.

### Simulation callback when assertion fails

An M-expression to be evaluated when the assertion fails.

### Stop simulation when assertion fails

If checked, this option causes the Check Dynamic Gap block to halt the simulation when the block's output is zero and display an error message in the **Simulation Diagnostics** viewer.

Otherwise, the block displays a warning message in the MATLAB Command Window and continues the simulation.

## Output assertion signal

If checked, this option causes the Check Dynamic Gap block to output a Boolean signal that is true (1) at each time step if the assertion succeeds and false (0) if the assertion fails. The data type of the output signal is Boolean if you have selected the Implement logic signals as boolean data option on the **Simulation and code generation** optimization pane of the **Configuration Parameters** dialog box. Otherwise the data type of the output signal is double.

## Select icon type

Type of icon used to display this block in a block diagram: either graphic or text. The graphic option displays a graphical representation of the assertion condition on the icon. The text option displays a mathematical expression that represents the assertion condition. If the icon is too small to display the expression, the text icon displays an exclamation point. To see the expression, enlarge the block.

## Characteristics

Direct Feedthrough	No
Sample Time	Inherited from driving block
Scalar Expansion	No
Dimensionalized	Yes
Zero Crossing	No

# Check Dynamic Lower Bound

---

**Purpose** Check that one signal is always less than another signal

**Library** Model Verification

## Description

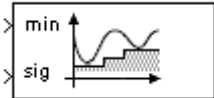

The Check Dynamic Lower Bound block checks that the amplitude of a reference signal is less than the amplitude of a test signal at the current time step. The test signal is the signal connected to the input labeled *sig*. If the verification condition is true, the block does nothing. If not, the block halts the simulation, by default, and displays an error message.

The Check Dynamic Lower Bound block and its companion blocks in the Model Verification library are intended to facilitate creation of self-validating models. For example, you can use model verification blocks to test that signals do not exceed specified limits during simulation. When you are satisfied that a model is correct, you can turn error checking off by disabling the verification blocks. You do not have to physically remove them from the model. If you need to modify a model, you can temporarily turn the verification blocks back on to ensure that your changes do not break the model.

## Data Type Support

The Check Dynamic Lower Bound block accepts input signals of any data type supported by Simulink. The test and the reference signals must have the same dimensions and data type. If the inputs are nonscalar, the block checks each element of the input test signal to the corresponding elements of the reference signal.

For a discussion on the data types supported by Simulink, see “Data Types Supported by Simulink” in the “Working with Data” chapter of the Using Simulink documentation.



## Parameters and Dialog Box

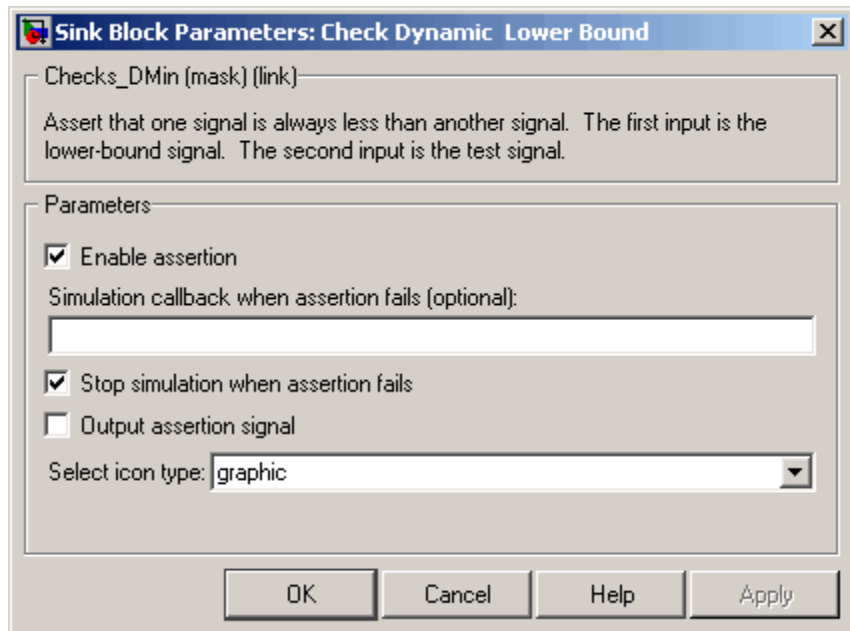

### Enable assertion

Unchecking this option disables the Check Dynamic Lower Bound block, that is, causes the model to behave as if the block did not exist. The **Model Verification block enabling** setting under **Debugging** on the **Data Validity** diagnostics pane of the **Configuration Parameters** dialog box allows you to enable or disable all model verification blocks, including Check Dynamic Lower Bound blocks, in a model regardless of the setting of this option.

### Simulation callback when assertion fails

An M-expression to be evaluated when the assertion fails.

### Stop simulation when assertion fails

If checked, this option causes the Check Dynamic Lower Bound block to halt the simulation when the block's output is zero and display an error message in the **Simulation Diagnostics** viewer.

# Check Dynamic Lower Bound

---

Otherwise, the block displays a warning message in the MATLAB Command Window and continues the simulation.

## Output assertion signal

If checked, this option causes the Check Dynamic Lower Bound block to output a Boolean signal that is true (1) at each time step if the assertion succeeds and false (0) if the assertion fails. The data type of the output signal is Boolean if you have selected the Implement logic signals as boolean data option on the **Simulation and code generation** optimization pane of the **Configuration Parameters** dialog box. Otherwise the data type of the output signal is double.

## Select icon type

Type of icon used to display this block in a block diagram: either graphic or text. The graphic option displays a graphical representation of the assertion condition on the icon. The text option displays a mathematical expression that represents the assertion condition. If the icon is too small to display the expression, the text icon displays an exclamation point. To see the expression, enlarge the block.

## Characteristics

Direct Feedthrough	No
Sample Time	Inherited from driving block
Scalar Expansion	No
Dimensionalized	Yes
Zero Crossing	No

**Purpose** Check that signal falls inside range of amplitudes that varies from time step to time step

**Library** Model Verification

## Description

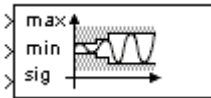

The Check Dynamic Range block checks that a test signal falls inside a range of amplitudes at each time step. The width of the range can vary from time step to time step. The input labeled *sig* is the test signal. The inputs labeled *min* and *max* are the lower and upper bounds of the valid range at the current time step. If the verification condition is true, the block does nothing. If not, the block halts the simulation, by default, and displays an error message.

The Check Dynamic Range block and its companion blocks in the Model Verification library are intended to facilitate creation of self-validating models. For example, you can use model verification blocks to test that signals do not exceed specified limits during simulation. When you are satisfied that a model is correct, you can turn error checking off by disabling the verification blocks. You do not have to physically remove them from the model. If you need to modify a model, you can temporarily turn the verification blocks back on to ensure that your changes do not break the model.

## Data Type Support

The Check Dynamic Range block accepts input signals of any dimensions and of any data type supported by Simulink. All three input signals must have the same dimension and data type. If the inputs are nonscalar, the block checks each element of the input test signal to the corresponding elements of the reference signals.

For a discussion on the data types supported by Simulink, see “Data Types Supported by Simulink” in the “Working with Data” chapter of the Using Simulink documentation.

# Check Dynamic Range

## Parameters and Dialog Box

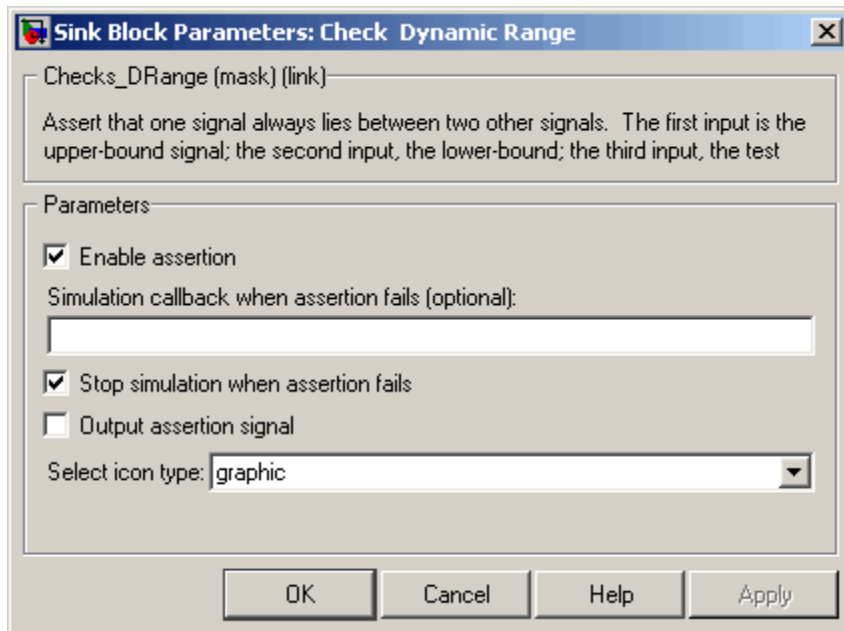

### Enable assertion

Unchecking this option disables the Check Dynamic Range block, that is, causes the model to behave as if the block did not exist. The **Model Verification block enabling** setting under **Debugging** on the **Data Validity** diagnostics pane of the **Configuration Parameters** dialog box allows you to enable or disable all model verification blocks in a model, including Check Dynamic Range blocks, regardless of the setting of this option.

### Simulation callback when assertion fails

An M-expression to be evaluated when the assertion fails.

### Stop simulation when assertion fails

If checked, this option causes the Check Dynamic Range block to halt the simulation when the block's output is zero and display an error message in the **Simulation Diagnostics** viewer.

Otherwise, the block displays a warning message in the MATLAB Command Window and continues the simulation.

## Output assertion signal

If checked, this option causes the Check Dynamic Range block to output a Boolean signal that is true (1) at each time step if the assertion succeeds and false (0) if the assertion fails. The data type of the output signal is Boolean if you selected the Implement logic signals as boolean data option on the **Simulation and code generation** optimization pane of the **Configuration Parameters** dialog box. Otherwise the data type of the output signal is double.

## Select icon type

Type of icon used to display this block in a block diagram: either graphic or text. The graphic option displays a graphical representation of the assertion condition on the icon. The text option displays a mathematical expression that represents the assertion condition. If the icon is too small to display the expression, the text icon displays an exclamation point. To see the expression, enlarge the block.

## Characteristics

Direct Feedthrough	No
Sample Time	Inherited from driving block
Scalar Expansion	No
Dimensionalized	Yes
Zero Crossing	No

# Check Dynamic Upper Bound

---

**Purpose** Check that one signal is always greater than another signal

**Library** Model Verification

## Description

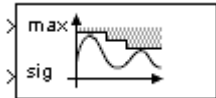

The Check Dynamic Upper Bound block checks that the amplitude of a reference signal is greater than the amplitude of a test signal at the current time step. The test signal is the signal connected to the input labeled *sig*. If the verification condition is true, the block does nothing. If not, the block halts the simulation, by default, and displays an error message.

The Check Dynamic Upper Bound block and its companion blocks in the Model Verification library are intended to facilitate creation of self-validating models. For example, you can use model verification blocks to test that signals do not exceed specified limits during simulation. When you are satisfied that a model is correct, you can turn error-checking off by disabling the verification blocks. You do not have to physically remove them from the model. If you need to modify a model, you can temporarily turn the verification blocks back on to ensure that your changes do not break the model.

## Data Type Support

The Check Dynamic Upper Bound block accepts input signals of any dimensions and of any data type supported by Simulink. The test and the reference signals must have the same dimensions and data type. If the inputs are nonscalar, the block compares each element of the input test signal to the corresponding elements of the reference signal.

For a discussion on the data types supported by Simulink, see “Data Types Supported by Simulink” in the “Working with Data” chapter of the Using Simulink documentation.

## Parameters and Dialog Box

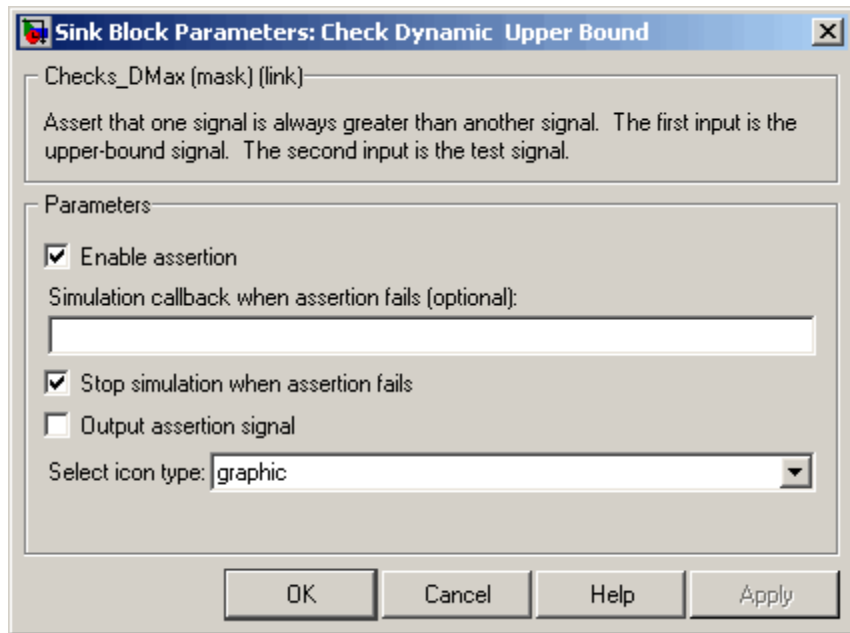

### Enable assertion

Unchecking this option disables the Check Dynamic Upper Bound block, that is, causes the model to behave as if the block did not exist. The **Model Verification block enabling** setting under **Debugging** on the **Data Validity** diagnostics pane of the **Configuration Parameters** dialog box allows you to enable or disable all model verification blocks, including Check Dynamic Upper Bound blocks, in a model regardless of the setting of this option.

### Simulation callback when assertion fails

An M-expression to be evaluated when the assertion fails.

### Stop simulation when assertion fails

If checked, this option causes the Check Dynamic Upper Bound block to halt the simulation when the block's output is zero and display an error message in the **Simulation Diagnostics** viewer.

# Check Dynamic Upper Bound

---

Otherwise, the block displays a warning message in the MATLAB Command Window and continues the simulation.

## Output assertion signal

If checked, this option causes the Check Dynamic Upper Bound block to output a Boolean signal that is true (1) at each time step if the assertion succeeds and false (0) if the assertion fails. The data type of the output signal is Boolean if you have selected the Implement logic signals as boolean data option on the **Simulation and code generation** optimization pane of the **Configuration Parameters** dialog box. Otherwise the data type of the output signal is double.

## Select icon type

Type of icon used to display this block in a block diagram: either graphic or text. The graphic option displays a graphical representation of the assertion condition on the icon. The text option displays a mathematical expression that represents the assertion condition. If the icon is too small to display the expression, the text icon displays an exclamation point. To see the expression, enlarge the block.

## Characteristics

Direct Feedthrough	No
Sample Time	Inherited from driving block
Scalar Expansion	No
Dimensionalized	Yes
Zero Crossing	No



## Purpose

Check that input signal has specified resolution

## Library

Model Verification

## Description

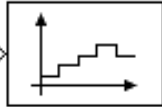

The Check Input Resolution block checks whether the input signal has a specified scalar or vector resolution (see Resolution). If the resolution is a scalar, the input signal must be a multiple of the resolution within a 10e-3 tolerance. If the resolution is a vector, the input signal must equal an element of the resolution vector. If the verification condition is true, the block does nothing. If not, the block halts the simulation, by default, and displays an error message.

The Check Input Resolution block and its companion blocks in the Model Verification library are intended to facilitate creation of self-validating models. For example, you can use model verification blocks to test that signals do not exceed specified limits during simulation. When you are satisfied that a model is correct, you can turn error checking off by disabling the verification blocks. You do not have to physically remove them from the model. If you need to modify a model, you can temporarily turn the verification blocks back on to ensure that your changes do not break the model.

## Data Type Support

The Check Input Resolution block accepts input signals of data type `double` and of any dimension. If the input signal is nonscalar, the block checks the resolution of each element of the input test signal.

For a discussion on the data types supported by Simulink, see “Data Types Supported by Simulink” in the “Working with Data” chapter of the Using Simulink documentation.

# Check Input Resolution

## Parameters and Dialog Box

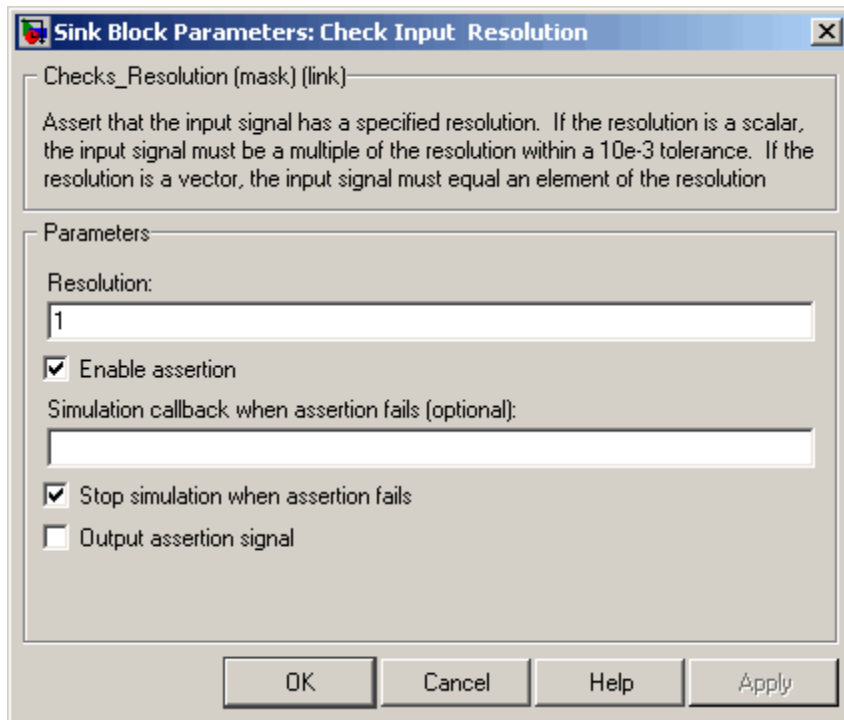

### Resolution

Resolution that the input signal must have.

### Enable assertion

Unchecking this option disables the Check Input Resolution block, that is, causes the model to behave as if the block did not exist. The **Model Verification block enabling** setting under **Debugging** on the **Data Validity** diagnostics pane of the **Configuration Parameters** dialog box allows you to enable or disable all model verification blocks in a model, including Check Input Resolution blocks, regardless of the setting of this option.

### Simulation callback when assertion fails

An M-expression to be evaluated when the assertion fails.

## Stop simulation when assertion fails

If checked, this option causes the Check Input Resolution block to halt the simulation when the block's output is zero and display an error message in the **Simulation Diagnostics** viewer. Otherwise, the block displays a warning message in the MATLAB Command Window and continues the simulation.

## Output assertion signal

If checked, this option causes the Check Input Resolution block to output a Boolean signal that is true (1) at each time step if the assertion succeeds and false (0) if the assertion fails. The data type of the output signal is Boolean if you have selected the Implement logic signals as boolean data option on the **Simulation and code generation** optimization pane of the **Configuration Parameters** dialog box. Otherwise the data type of the output signal is double.

## Characteristics

Direct Feedthrough	No
Sample Time	Inherited from driving block
Scalar Expansion	No
Dimensionalized	Yes
Zero Crossing	No

# Check Static Gap

---

**Purpose** Check that gap exists in signal's range of amplitudes

**Library** Model Verification

## Description

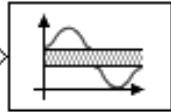

The Check Static Gap block checks that each element of the input signal is less than (or optionally equal to) a static lower bound or greater than (or optionally equal to) a static upper bound at the current time step. If the verification condition is true, the block does nothing. If not, the block halts the simulation, by default, and displays an error message.

The Check Static Gap block and its companion blocks in the Model Verification library are intended to facilitate creation of self-validating models. For example, you can use model verification blocks to test that signals do not exceed specified limits during simulation. When you are satisfied that a model is correct, you can turn error checking off by disabling the verification blocks. You do not have to physically remove them from the model. If you need to modify a model, you can temporarily turn the verification blocks back on to ensure that your changes do not break the model.

## Data Type Support

The Check Static Gap block accepts input signals of any dimensions and of any data type supported by Simulink.

For a discussion on the data types supported by Simulink, see “Data Types Supported by Simulink” in the “Working with Data” chapter of the Using Simulink documentation.

## Parameters and Dialog Box

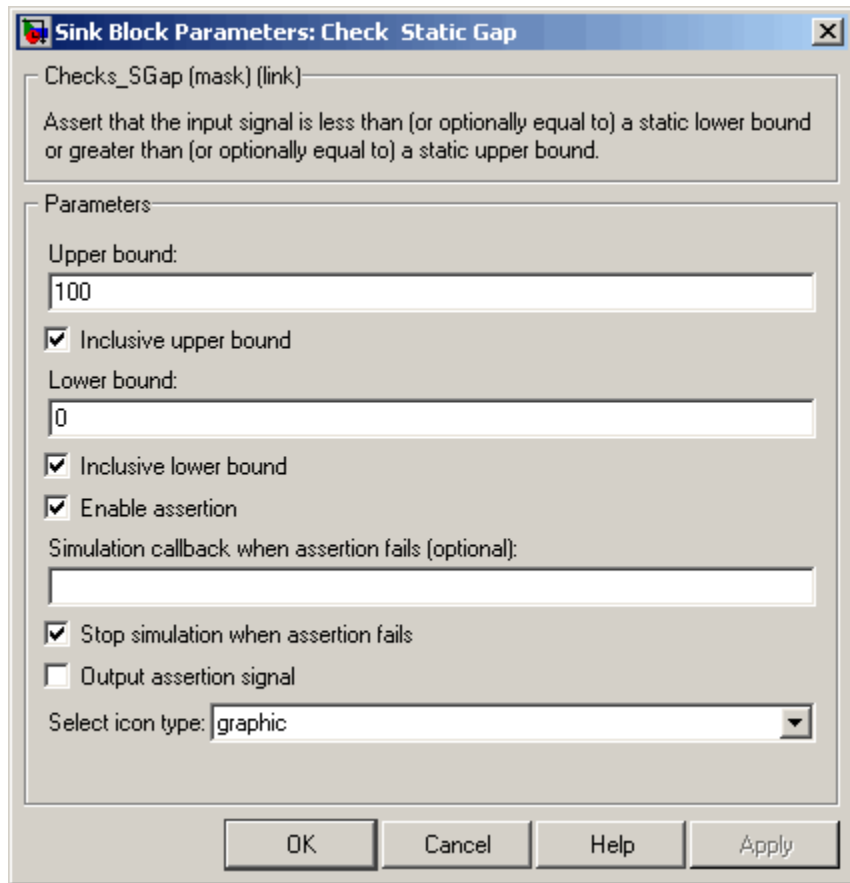

### Upper bound

Upper bound of the gap in the input signal's range of amplitudes.

### Inclusive upper bound

If checked, this option specifies that the gap includes the upper bound.

### Lower bound

Lower bound of the gap in the input signal's range of amplitudes.

# Check Static Gap

---

## **Inclusive lower bound**

If checked, this option specifies that the gap includes the lower bound.

## **Enable assertion**

Unchecking this option disables the Check Static Gap block, that is, causes the model to behave as if the block did not exist. The **Model Verification block enabling** setting under **Debugging** on the **Data Validity** diagnostics pane of the **Configuration Parameters** dialog box allows you to enable or disable all model verification blocks in a model, including Check Static Gap blocks, regardless of the setting of this option.

## **Simulation callback when assertion fails**

An M-expression to be evaluated when the assertion fails.

## **Stop simulation when assertion fails**

If checked, this option causes the Check Static Gap block to halt the simulation when the block's output is zero and display an error message in the **Simulation Diagnostics** viewer. Otherwise, the block displays a warning message in the MATLAB Command Window and continues the simulation.

## **Output assertion signal**

If checked, this option causes the Check Static Gap block to output a Boolean signal that is true (1) at each time step if the assertion succeeds and false (0) if the assertion fails. The data type of the output signal is Boolean if you have selected the Implement logic signals as boolean data option on the **Simulation and code generation** optimization pane of the **Configuration Parameters** dialog box. Otherwise the data type of the output signal is double.

## **Select icon type**

Type of icon used to display this block in a block diagram: either graphic or text. The graphic option displays a graphical representation of the assertion condition on the icon. The text option displays a mathematical expression that represents the assertion condition. If the icon is too small to display the

expression, the text icon displays an exclamation point. To see the expression, enlarge the block.

## Characteristics

Direct Feedthrough	No
Sample Time	Inherited from driving block
Scalar Expansion	No
Dimensionalized	Yes
Zero Crossing	No

# Check Static Lower Bound

---

**Purpose** Check that signal is greater than (or optionally equal to) static lower bound

**Library** Model Verification

## Description

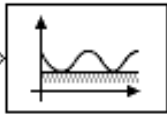

The Check Static Lower Bound block checks that each element of the input signal is greater than (or optionally equal to) a specified lower bound at the current time step. The block's parameter dialog box allows you to specify the value of the lower bound and whether the lower bound is inclusive. If the verification condition is true, the block does nothing. If not, the block halts the simulation, by default, and displays an error message.

The Check Static Lower Bound block and its companion blocks in the Model Verification library are intended to facilitate creation of self-validating models. For example, you can use model verification blocks to test that signals do not exceed specified limits during simulation. When you are satisfied that a model is correct, you can turn error checking off by disabling the verification blocks. You do not have to physically remove them from the model. If you need to modify a model, you can temporarily turn the verification blocks back on to ensure that your changes do not break the model.

## Data Type Support

The Check Static Lower Bound block accepts input signals of any dimensions and of any data type supported by Simulink.

For a discussion on the data types supported by Simulink, see “Data Types Supported by Simulink” in the “Working with Data” chapter of the Using Simulink documentation.



## Parameters and Dialog Box

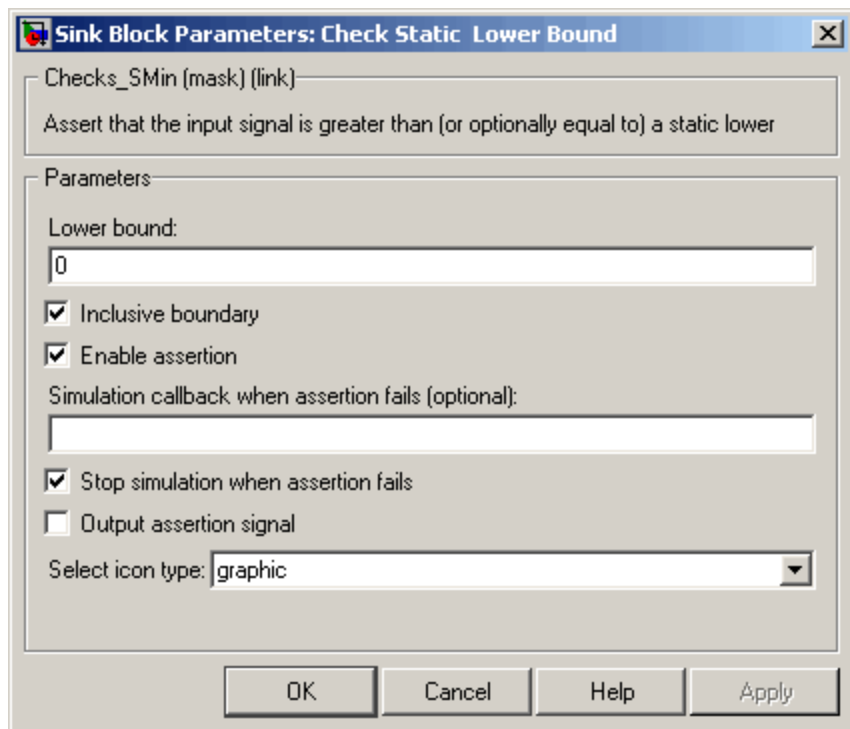

### Lower bound

Lower bound on the range of amplitudes that the input signal can have.

### Inclusive boundary

Checking this option makes the range of valid input amplitudes include the lower bound.

### Enable assertion

Unchecking this option disables the Check Static Lower Bound block, that is, causes the model to behave as if the block did not exist. The **Model Verification block enabling** setting under **Debugging** on the **Data Validity** diagnostics pane of the **Configuration Parameters** dialog box allows you to enable or

# Check Static Lower Bound

---

disable all model verification blocks in a model, including Check Static Lower Bound blocks, regardless of the setting of this option.

## Simulation callback when assertion fails

An M-expression to be evaluated when the assertion fails.

## Stop simulation when assertion fails

If checked, this option causes the Check Static Lower Bound block to halt the simulation when the block's output is zero and display an error message in the **Simulation Diagnostics** viewer. Otherwise, the block displays a warning message in the MATLAB Command Window and continues the simulation.

## Output assertion signal

If checked, this option causes the Check Static Lower Bound block to output a Boolean signal that is true (1) at each time step if the assertion succeeds and false (0) if the assertion fails. The data type of the output signal is Boolean if you have selected the Implement logic signals as boolean data option on the **Simulation and code generation** optimization pane of the **Configuration Parameters** dialog box. Otherwise the data type of the output signal is double.

## Select icon type

Type of icon used to display this block in a block diagram: either graphic or text. The graphic option displays a graphical representation of the assertion condition on the icon. The text option displays a mathematical expression that represents the assertion condition. If the icon is too small to display the expression, the text icon displays an exclamation point. To see the expression, enlarge the block.

## Characteristics

Direct Feedthrough	No
Sample Time	Inherited from driving block
Scalar Expansion	No

## Check Static Lower Bound

---

Dimensionalized	Yes
Zero Crossing	No

# Check Static Range

---

**Purpose** Check that signal falls inside fixed range of amplitudes

**Library** Model Verification

## Description

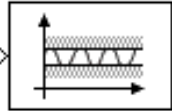

The Check Static Range block checks that each element of the input signal falls inside the same range of amplitudes at each time step. The block's parameter dialog box allows you to specify the upper and lower bounds of the valid amplitude range and whether the range includes the bounds. If the verification condition is true, the block does nothing. If not, the block halts the simulation, by default, and displays an error message.

The Check Static Range block and its companion blocks in the Model Verification library are intended to facilitate creation of self-validating models. For example, you can use model verification blocks to test that signals do not exceed specified limits during simulation. When you are satisfied that a model is correct, you can turn error checking off by disabling the verification blocks. You do not have to physically remove them from the model. If you need to modify a model, you can temporarily turn the verification blocks back on to ensure that your changes do not break the model.

## Data Type Support

The Check Static Range block accepts input signals of any dimensions and of any data type supported by Simulink.

For a discussion on the data types supported by Simulink, see “Data Types Supported by Simulink” in the “Working with Data” chapter of the Using Simulink documentation.

## Parameters and Dialog Box

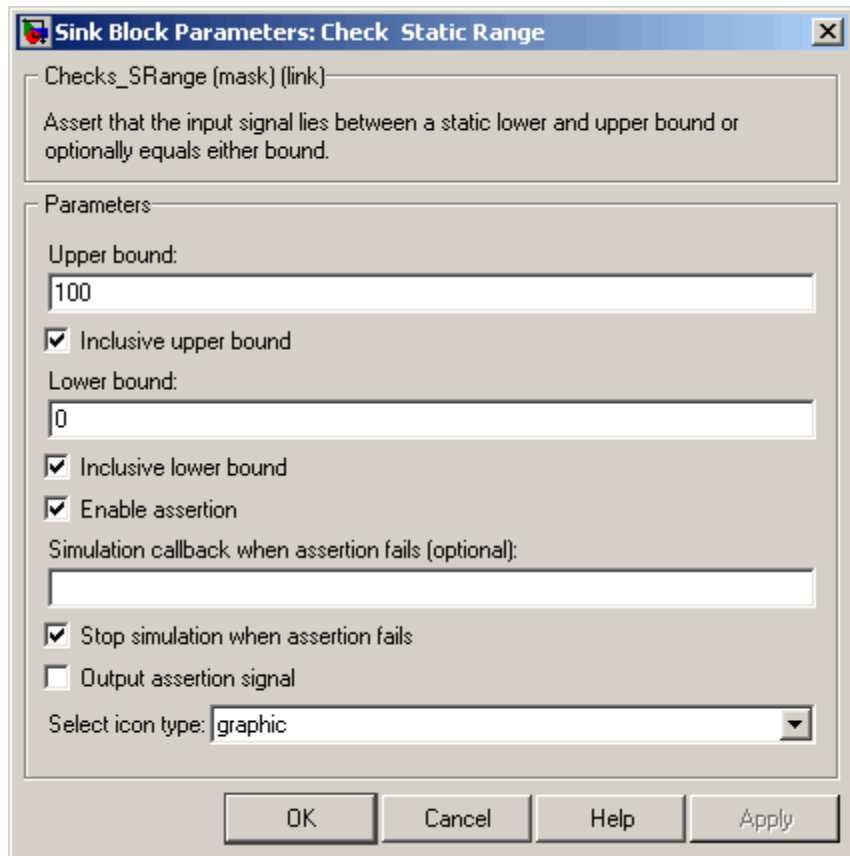

### Upper bound

Upper bound of the range of valid input signal amplitudes.

### Inclusive upper bound

Checking this option specifies that the valid signal range includes the upper bound.

### Lower bound

Lower bound of the range of valid input signal amplitudes.

# Check Static Range

---

## **Inclusive lower bound**

Checking this option specifies that the valid signal range includes the lower bound.

## **Enable assertion**

Unchecking this option disables the Check Static Range block, that is, causes the model to behave as if the block did not exist. The **Model Verification block enabling** setting under **Debugging** on the **Data Validity** diagnostics pane of the **Configuration Parameters** dialog box allows you to enable or disable all model verification blocks in a model, including Check Static Range blocks, regardless of the setting of this option.

## **Simulation callback when assertion fails**

An M-expression to be evaluated when the assertion fails.

## **Stop simulation when assertion fails**

If checked, this option causes the Check Static Range block to halt the simulation when the block's output is zero and display an error message in the **Simulation Diagnostics** viewer. Otherwise, the block displays a warning message in the MATLAB Command Window and continues the simulation.

## **Output assertion signal**

If checked, this option causes the Check Static Range block to output a Boolean signal that is true (1) at each time step if the assertion succeeds and false (0) if the assertion fails. The data type of the output signal is Boolean if you have selected the **Implement logic signals as boolean data** option on the **Simulation and code generation** optimization pane of the **Configuration Parameters** dialog box. Otherwise the data type of the output signal is double.

## **Select icon type**

Type of icon used to display this block in a block diagram: either graphic or text. The graphic option displays a graphical representation of the assertion condition on the icon. The text option displays a mathematical expression that represents the assertion condition. If the icon is too small to display the

expression, the text icon displays an exclamation point. To see the expression, enlarge the block.

### Characteristics

Direct Feedthrough	No
Sample Time	Inherited from driving block
Scalar Expansion	No
Dimensionalized	Yes
Zero Crossing	No

# Check Static Upper Bound

---

**Purpose** Check that signal is less than (or optionally equal to) static upper bound

**Library** Model Verification

## Description

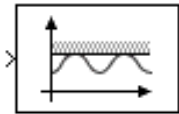

The Check Static Upper Bound block checks that each element of the input signal is less than (or optionally equal to) a specified upper bound at the current time step. The block's parameter dialog box allows you to specify the value of the upper bound and whether the bound is inclusive. If the verification condition is true, the block does nothing. If not, the block halts the simulation, by default, and displays an error message.

The Check Static Upper Bound block and its companion blocks in the Model Verification library are intended to facilitate creation of self-validating models. For example, you can use model verification blocks to test that signals do not exceed specified limits during simulation. When you are satisfied that a model is correct, you can turn error checking off by disabling the verification blocks. You do not have to physically remove them from the model. If you need to modify a model, you can temporarily turn the verification blocks back on to ensure that your changes do not break the model.

## Data Type Support

The Check Static Upper Bound block accepts input signals of any dimensions and of any data type supported by Simulink.

For a discussion on the data types supported by Simulink, see “Data Types Supported by Simulink” in the “Working with Data” chapter of the Using Simulink documentation.



## Parameters and Dialog Box

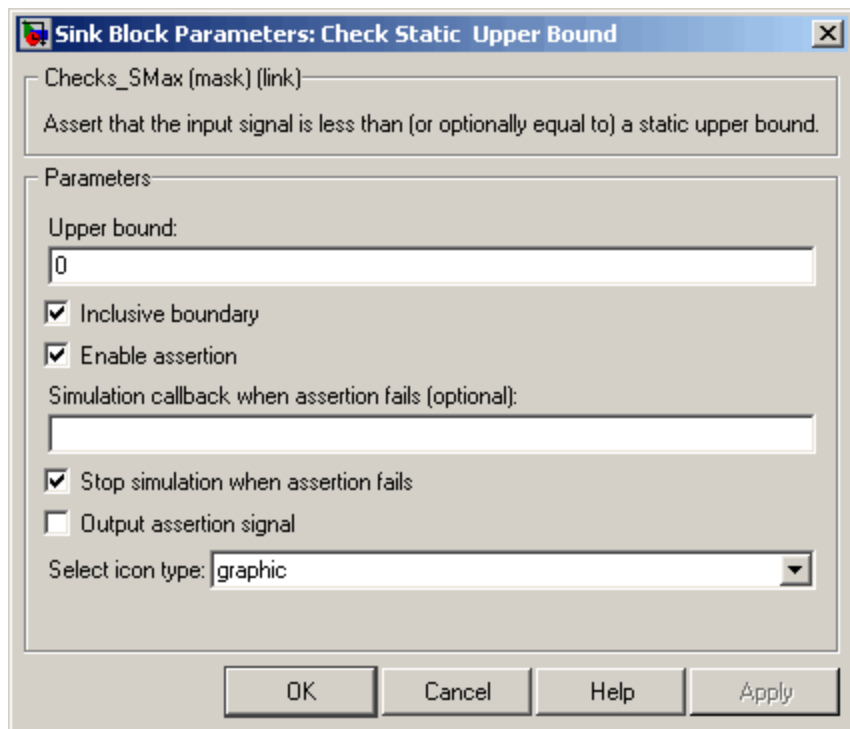

### Upper bound

Upper bound on the range of amplitudes that the input signal can have.

### Inclusive boundary

Checking this option makes the range of valid input amplitudes include the upper bound.

### Enable assertion

Unchecking this option disables the Check Static Upper Bound block, that is, causes the model to behave as if the block did not exist. The **Model Verification block enabling** setting under **Debugging** on the **Data Validity** diagnostics pane of the **Configuration Parameters** dialog box allows you to enable or

# Check Static Upper Bound

---

disable all model verification blocks in a model, including Check Static Upper Bound blocks, regardless of the setting of this option.

## Simulation callback when assertion fails

An M-expression to be evaluated when the assertion fails.

## Stop simulation when assertion fails

If checked, this option causes the Check Static Upper Bound block to halt the simulation when the block's output is zero and display an error message in the **Simulation Diagnostics** viewer. Otherwise, the block displays a warning message in the MATLAB Command Window and continues the simulation.

## Output assertion signal

If checked, this option causes the Check Static Upper Bound block to output a Boolean signal that is true (1) at each time step if the assertion succeeds and false (0) if the assertion fails. The data type of the output signal is Boolean if you have selected the Implement logic signals as boolean data option on the **Simulation and code generation** optimization pane of the **Configuration Parameters** dialog box. Otherwise the data type of the output signal is double.

## Select icon type

Type of icon used to display this block in a block diagram: either graphic or text. The graphic option displays a graphical representation of the assertion condition on the icon. The text option displays a mathematical expression that represents the assertion condition. If the icon is too small to display the expression, the text icon displays an exclamation point. To see the expression, enlarge the block.

## Characteristics

Direct Feedthrough	No
Sample Time	Inherited from driving block
Scalar Expansion	No

# Check Static Upper Bound

---

Dimensionalized	Yes
Zero Crossing	No

# Chirp Signal

---

**Purpose** Generate sine wave with increasing frequency

**Library** Sources

## Description



The Chirp Signal block generates a sine wave whose frequency increases at a linear rate with time. You can use this block for spectral analysis of nonlinear systems. The block generates a scalar or vector output.

The parameters, **Initial frequency**, **Target time**, and **Frequency at target time**, determine the block's output. You can specify any or all of these variables as scalars or arrays. All the parameters specified as arrays must have the same dimensions. The block expands scalar parameters to have the same dimensions as the array parameters. The block output has the same dimensions as the parameters unless you select the **Interpret vector parameters as 1-D** option. If you select this option and the parameters are row or column vectors, the block outputs a vector (1-D array) signal.

## Data Type Support

The Chirp Signal block outputs a real-valued signal of type double.

## Parameters and Dialog Box

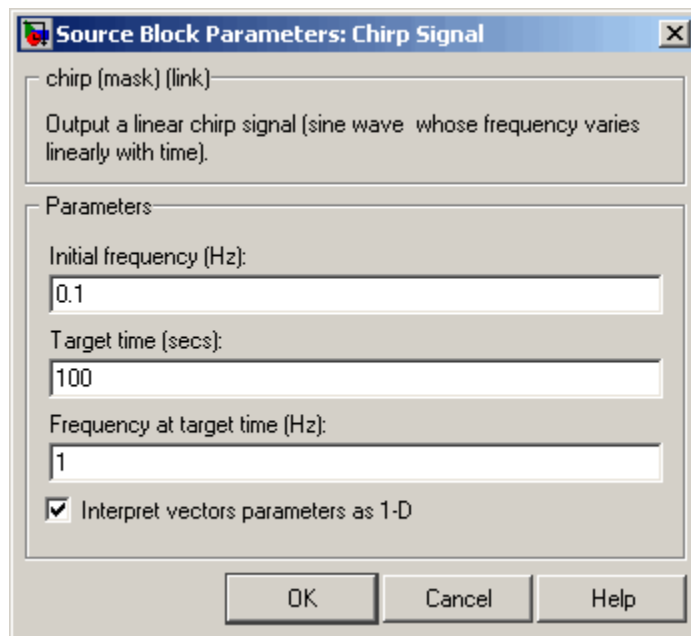

Opening this dialog box causes a running simulation to pause. See “Changing Source Block Parameters During Simulation” in the “Working with Blocks” chapter of the Using Simulink documentation.

### Initial frequency

The initial frequency of the signal, specified as a scalar or matrix value. The default is 0.1 Hz.

### Target time

The time at which the frequency reaches the **Frequency at target time** parameter value, a scalar or matrix value. The frequency continues to change at the same rate after this time. The default is 100 seconds.

### Frequency at target time

The frequency of the signal at the target time, a scalar or matrix value. The default is 1 Hz.

# Chirp Signal

---

## Interpret vector parameters as 1-D

If selected, column or row matrix values for the **Initial frequency**, **Target time**, and **Frequency at target time** parameters result in a vector output whose elements are the elements of the row or column. See “Determining the Output Dimensions of Source Blocks” in the “Working with Signals” chapter of the Using Simulink documentation.

## Characteristics

Sample Time	Continuous
Scalar Expansion	Yes, of parameters
Dimensionalized	Yes
Zero Crossing	No

**Purpose** Display and provide simulation time

**Library** Sources

## Description



The Clock block outputs the current simulation time at each simulation step. This block is useful for other blocks that need the simulation time.

When you need the current time within a discrete system, use the Digital Clock block.

## Data Type Support

The Clock block outputs a real-valued signal of type double.

## Parameters and Dialog Box

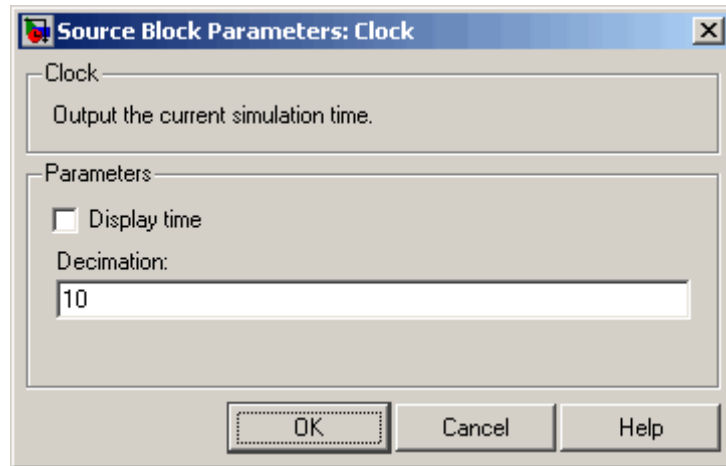

### Display time

Use the **Display time** check box to display the current simulation time inside the Clock icon.

### Decimation

The **Decimation** parameter value is the increment at which Simulink updates the Clock icon when **Display time** is checked. Specify a positive integer (the default is 10). For example, if

# Clock

---

the decimation is 1000, then, for a fixed integration step of 1 millisecond, the Clock icon updates at 1 second, 2 seconds, and so on.

## Characteristics

Sample Time	Continuous
Scalar Expansion	N/A
Dimensionalized	No
Zero Crossing	No



**Purpose** Implement truth table

**Library** Logic and Bit Operations

## Description



The Combinatorial Logic block implements a standard truth table for modeling programmable logic arrays (PLAs), logic circuits, decision tables, and other Boolean expressions. You can use this block in conjunction with Memory blocks to implement finite-state machines or flip-flops.

You specify a matrix that defines all possible block outputs as the **Truth table** parameter. Each row of the matrix contains the output for a different combination of input elements. You must specify outputs for every combination of inputs. The number of columns is the number of block outputs.

The relationship between the number of inputs and the number of rows is

$$\text{number of rows} = 2^{\text{(number of inputs)}}$$

Simulink returns a row of the matrix by computing the row's index from the input vector elements. Simulink computes the index by building a binary number where input vector elements having zero values are 0 and elements having nonzero values are 1, then adding 1 to the result. For an input vector,  $u$ , of  $m$  elements,

$$\text{row index} = 1 + u(m) * 2^0 + u(m-1) * 2^1 + \dots + u(1) * 2^{m-1}$$

### Example of Two-Input AND Function

This example builds a two-input AND function, which returns 1 when both input elements are 1, and 0 otherwise. To implement this function, specify the **Truth table** parameter value as [0; 0; 0; 1]. The portion of the model that provides the inputs to and the output from the Combinatorial Logic block might look like this.

# Combinatorial Logic

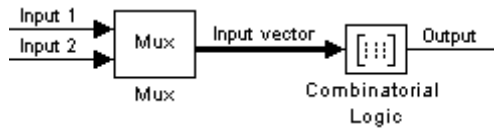

The following table indicates the combination of inputs that generate each output. The input signal labeled “Input 1” corresponds to the column in the table labeled Input 1. Similarly, the input signal “Input 2” corresponds to the column with the same name. The combination of these values determines the row of the Output column of the table that is passed as block output.

For example, if the input vector is [ 1 0 ], the input references the third row:

$$(2^{1*1} + 1)$$

The output value is 0.

Row	Input 1	Input 2	Output
1	0	0	0
2	0	1	0
3	1	0	0
4	1	1	1

## Example of Circuit

This sample circuit has three inputs: the two bits (**a** and **b**) to be summed and a carry-in bit (**c**). It has two outputs: the carry-out bit (**c'**) and the sum bit (**s**). Here are the truth table and the outputs associated with each combination of input values for this circuit.

Inputs			Outputs	
a	b	c	c'	s
0	0	0	0	0
0	0	1	0	1
0	1	0	0	1
0	1	1	1	0
1	0	0	0	1
1	0	1	1	0
1	1	0	1	0
1	1	1	1	1

To implement this adder with the Combinatorial Logic block, you enter the 8-by-2 matrix formed by columns **c'** and **s** as the **Truth table** parameter.

You can also implement sequential circuits (that is, circuits with states) with the Combinatorial Logic block by including an additional input for the state of the block and feeding the output of the block back into this state input.

## Data Type Support

The type of signals accepted by a Combinatorial Logic block depends on whether you selected the Boolean logic signals option (see “Implement logic signals as boolean data (vs. double)” in the “Working with Data” chapter of the Using Simulink documentation). If this option is enabled, the block accepts real signals of type Boolean or double. The **Truth table** parameter can have Boolean values (0 or 1) of any data type, including fixed-point data types. If the table contains non-Boolean values, the table’s data type must be double.

The type of the output is the same as that of the input except that the block outputs double if the input is Boolean and the truth table contains non-Boolean values.

# Combinatorial Logic

If Boolean compatibility mode is disabled, the Combinatorial Logic block accepts only signals of type Boolean. The block outputs double if the truth table contains non-Boolean values of type double. Otherwise, the output is Boolean.

## Parameters and Dialog Box

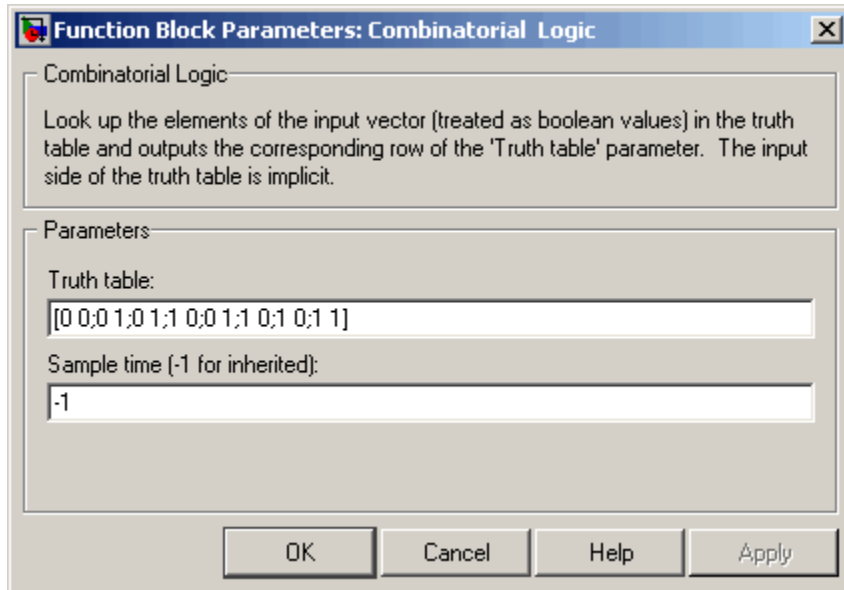

### Truth table

The matrix of outputs. Each column corresponds to an element of the output vector and each row corresponds to a row of the truth table.

### Sample time (-1 for inherited)

Specify the time interval between samples. To inherit the sample time, set this parameter to -1. See "Specifying Sample Time" in the "How Simulink Works" chapter of the Using Simulink documentation.

<b>Characteristics</b>	Direct Feedthrough	Yes
	Sample Time	Inherited from driving block
	Scalar Expansion	No
	Dimensionalized	Yes; the output width is the number of columns of the <b>Truth table</b> parameter
	Zero Crossing	No

# Compare To Constant

---

**Purpose** Determine how signal compares to specified constant

**Library** Logic and Bit Operations

**Description** The Compare To Constant block compares an input signal to a constant. Specify the constant in the **Constant value** parameter. Specify how the input is compared to the constant value with the **Operator** parameter. The **Operator** parameter can have the following values:

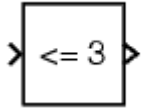

- == — Determine whether the input is equal to the specified constant.
- ~= — Determine whether the input is not equal to the specified constant.
- < — Determine whether the input is less than the specified constant.
- <= — Determine whether the input is less than or equal to the specified constant.
- > — Determine whether the input is greater than the specified constant.
- >= — Determine whether the input is greater than or equal to the specified constant.

The output is 0 if the comparison is false, and 1 if it is true.

**Data Type Support** The Compare To Constant block accepts inputs of any data type supported by Simulink, including fixed-point data types. The block output is uint8 or Boolean as specified by the **Output data type mode** parameter.

For a discussion on the data types supported by Simulink, see “Data Types Supported by Simulink” in the “Working with Data” chapter of the Using Simulink documentation.

## Parameters and Dialog Box

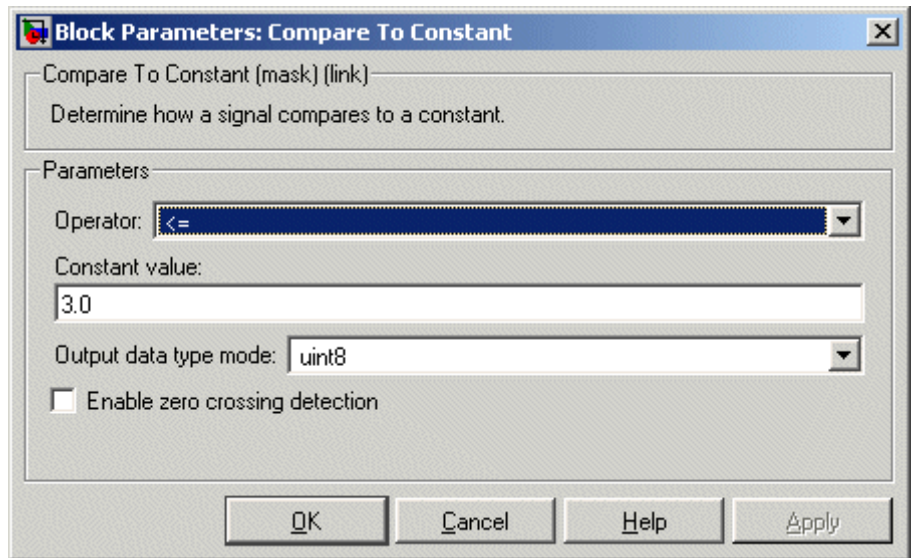

### Operator

Specify how the input is compared to the constant value, as discussed in Description.

### Constant value

Specify the constant value to which the input is compared.

### Output data type mode

Specify the data type of the output, uint8 or boolean.

### Enable zero crossing detection

Select to enable zero-crossing detection. For more information, see “Zero-Crossing Detection” in the “How Simulink Works” chapter of the Using Simulink documentation.

## Characteristics

Direct Feedthrough	Yes
Scalar Expansion	Yes

# Compare To Constant

---

Multidimensionalized	Yes
Zero Crossing	Yes, if enabled.

## See Also

Compare To Zero



**Purpose** Determine how signal compares to zero

**Library** Logic and Bit Operations

## Description

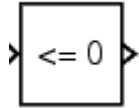

The Compare To Zero block compares an input signal to zero. Specify how the input is compared to zero with the **Operator** parameter. The **Operator** parameter can have the following values:

- == — Determine whether the input is equal to zero.
- ~= — Determine whether the input is not equal to zero.
- < — Determine whether the input is less than zero.
- <= — Determine whether the input is less than or equal to zero.
- > — Determine whether the input is greater than zero.
- >= — Determine whether the input is greater than or equal to zero.

The output is 0 if the comparison is false, and 1 if it is true.

## Data Type Support

The Compare To Zero block accepts inputs of any data type supported by Simulink, including fixed-point data types. The block output is `uint8` or `Boolean` as specified by the **Output data type mode** parameter.

For a discussion on the data types supported by Simulink, see “Data Types Supported by Simulink” in the “Working with Data” chapter of the Using Simulink documentation.

# Compare To Zero

## Parameters and Dialog Box

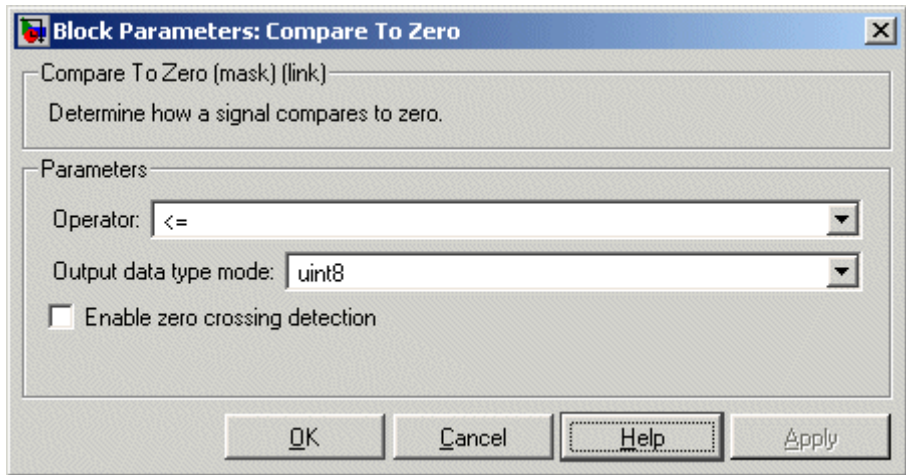

### Operator

Specify how the input is compared to zero, as discussed in Description.

### Output data type mode

Specify the data type of the output, uint8 or boolean.

### Enable zero crossing detection

Select to enable zero-crossing detection. For more information, see “Zero-Crossing Detection” in the “How Simulink Works” chapter of the Using Simulink documentation.

## Characteristics

Direct Feedthrough	Yes
Scalar Expansion	Yes
Zero Crossing	Yes, if enabled.
Multidimensionalized	Yes

## See Also

Compare To Constant

# Complex to Magnitude-Angle

**Purpose** Compute magnitude and/or phase angle of complex signal

**Library** Math Operations

## Description

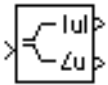

The Complex to Magnitude-Angle block accepts a complex-valued signal of type double or single. It outputs the magnitude and/or phase angle of the input signal, depending on the setting of the **Output** parameter. The outputs are real values of the same data type as the block input. The input can be an array of complex signals, in which case the output signals are also arrays. The magnitude signal array contains the magnitudes of the corresponding complex input elements. The angle output similarly contains the angles of the input elements.

**Data Type Support** See the preceding description.

## Parameters and Dialog Box

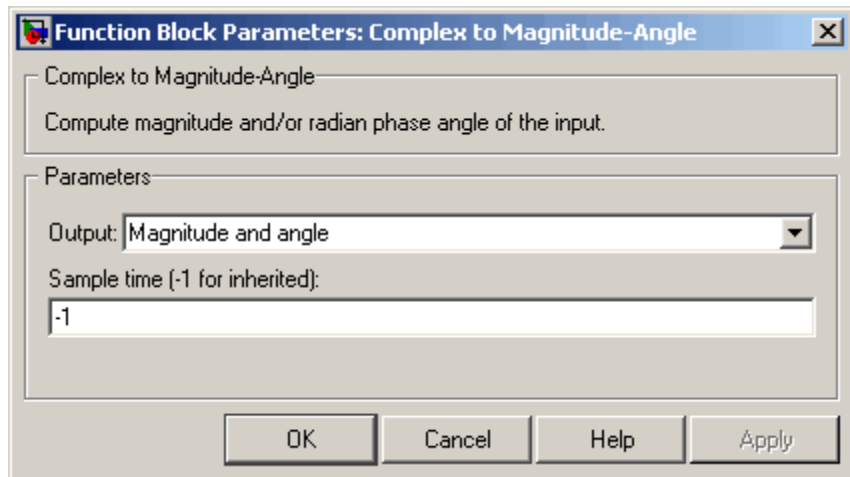

## Output

Determines the output of this block. Choose from the following values: Magnitude and angle (outputs the input signal's magnitude and phase angle in radians), Magnitude (outputs the

# Complex to Magnitude-Angle

---

input's magnitude), Angle (outputs the input's phase angle in radians).

## **Sample time (-1 for inherited)**

Specify the time interval between samples. To inherit the sample time, set this parameter to -1. See "Specifying Sample Time" in the "How Simulink Works" chapter of the Using Simulink documentation.

## **Characteristics**

Direct Feedthrough	Yes
Sample Time	Inherited from driving block
Scalar Expansion	No
Dimensionalized	Yes
Multidimensionalized	Yes
Zero Crossing	No

**Purpose** Output real and imaginary parts of complex input signal

**Library** Math Operations

## Description

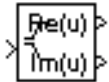

The Complex to Real-Imag block accepts a complex-valued signal of any data type supported by Simulink, including fixed-point data types. It outputs the real and/or imaginary part of the input signal, depending on the setting of the **Output** parameter. The real outputs are of the same data type as the complex input. The input can be an array (vector or matrix) of complex signals, in which case the output signals are arrays of the same dimensions. The real array contains the real parts of the corresponding complex input elements. The imaginary output similarly contains the imaginary parts of the input elements.

## Data Type Support

See the preceding description. For a discussion on the data types supported by Simulink, see “Data Types Supported by Simulink” in the “Working with Data” chapter of the Using Simulink documentation.

## Parameters and Dialog Box

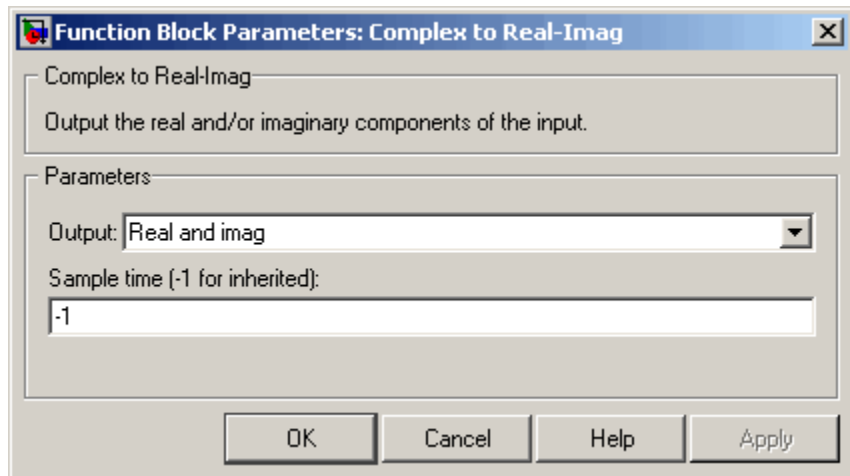

# Complex to Real-Imag

---

## Output

Determines the output of this block. Choose from the following values: Real and imag (outputs the input signal's real and imaginary parts), Real (outputs the input's real part), Imag (outputs the input's imaginary part).

## Sample time (-1 for inherited)

Specify the time interval between samples. To inherit the sample time, set this parameter to -1. See "Specifying Sample Time" in the "How Simulink Works" chapter of the Using Simulink documentation.

## Characteristics

Direct Feedthrough	Yes
Sample Time	Inherited from driving block
Scalar Expansion	No
Dimensionalized	Yes
Multidimensionalized	Yes
Zero Crossing	No

## Purpose

Represent any block selected from user-specified library of blocks

## Library

Ports & Subsystems

## Description



The Configurable Subsystem block represents one of a set of blocks contained in a specified library of blocks. The block's context menu lets you choose which block the configurable subsystem represents.

Configurable Subsystem blocks simplify creation of models that represent families of designs. For example, suppose that you want to model an automobile that offers a choice of engines. To model such a design, you would first create a library of models of the engine types available with the car. You would then use a Configurable Subsystem block in your car model to represent the choice of engines. To model a particular variant of the basic car design, a user need only choose the engine type, using the configurable engine block's dialog.

To create a configurable subsystem in a model, you must first create a library containing a master configurable subsystem and the blocks that it represents. You can then create configurable instances of the master subsystem by dragging copies of the master subsystem from the library and dropping them into models.

You can add any type of block to a master configurable subsystem library. Simulink derives the port names for the configurable subsystem by making a unique list from the port names of all the choices. Note that Simulink uses default port names for non-subsystem block choices.

Note that Simulink does not allow you to break library links in a configurable subsystem because Simulink needs the links to reconfigure the subsystem when you choose a new configuration. Breaking links would be useful only if you never intended to reconfigure the subsystem, in which case you could simply replace the configurable subsystem with a nonconfigurable subsystem that implements the permanent configuration.

### Creating a Master Configurable Subsystem

To create a master configurable subsystem:

# Configurable Subsystem

---

- 1 Create a library of blocks representing the various configurations of the configurable subsystem.
- 2 Save the library.
- 3 Create an instance of the Configurable Subsystem block in the library.

To do this, drag a copy of the Configurable Subsystem block from the Simulink Ports & Subsystems library into the library you created in the preceding step.

- 4 Display the Configurable Subsystem block's dialog by double-clicking it. The dialog displays a list of the other blocks in the library.
- 5 Under **List of block choices** in the dialog box, select the blocks that represent the various configurations of the configurable subsystems you are creating.
- 6 Click the **OK** button to apply the changes and close the dialog box.

- 7 Select **Block Choice** from the Configurable Subsystem block's context menu.

The context menu displays a submenu listing the blocks that the subsystem can represent.

- 8 Select the block that you want the subsystem to represent by default.
- 9 Save the library.

---

**Note** If you add or remove blocks from a library, you must recreate any Configurable Subsystem blocks that use the library.

---

If you modify a library block that is the default block choice for a configurable subsystem, the change does not immediately propagate to the configurable subsystem. To propagate this change, do one of the following:



- Change the default block choice to another block in the subsystem, then change the default block choice back to the original block.
- Recreate the configurable subsystem block, including the selection of the updated block as the default block choice.

## Creating an Instance of a Configurable Subsystem

To create an instance of a configurable subsystem in a model,

- 1 Open the library containing the master configurable subsystem.
- 2 Drag a copy of the master into the model.
- 3 Select **Block Choice** from the copy's context menu.
- 4 Select the block that you want the configurable subsystem to represent.

The instance of the configurable system displays the icon and parameter dialog box of the block that it represents.

## Setting Instance Block Parameters

As with other blocks, you can use the parameter dialog box of a configurable subsystem instance to set the instance's parameters interactively and the `set_param` command to set the parameters from the MATLAB command line or in an M-file program. If you use `set_param`, you must specify the full path name of the configurable subsystem's current block choice as the first argument of `set_param`, e.g.,

```
curr_choice = get_param('mymod/myconfigsys', 'BlockChoice');  
curr_choice = ['mymod/myconfigsys/' curr_choice];  
set_param(curr_choice, 'MaskValues', ...);
```

## Mapping I/O Ports

A configurable subsystem displays a set of input and output ports corresponding to input and output ports in the selected library.

# Configurable Subsystem

---

Simulink uses the following rules to map library ports to Configurable Subsystem block ports:

- Map each uniquely named input/output port in the library to a separate input/output port of the same name on the Configurable Subsystem block.
- Map all identically named input/output ports in the library to the same input/output ports on the Configurable Subsystem block.
- Terminate any input/output port not used by the currently selected library block with a Terminator/Ground block.

This mapping allows a user to change the library block represented by a Configurable Subsystem block without having to rewire connections to the Configurable Subsystem block.

For example, suppose that a library contains two blocks A and B and that block A has input ports labeled a, b, and c and an output port labeled d and that block B has input ports labeled a and b and an output port labeled e. A Configurable Subsystem block based on this library would have three input ports labeled a, b, and c, respectively, and two output ports labeled d and e, respectively, as illustrated in the following figure.

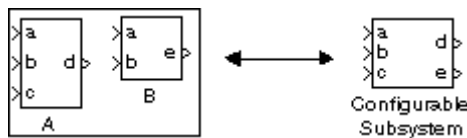

In this example, port a on the Configurable Subsystem block connects to port a of the selected library block no matter which block is selected. On the other hand, port c on the Configurable Subsystem block functions only if library block A is selected. Otherwise, it simply terminates.

**Note** A Configurable Subsystem block does not provide ports that correspond to non-I/O ports, such as the trigger and enable ports on triggered and enabled subsystems. Thus, you cannot use a Configurable Subsystem block directly to represent blocks that have such ports. You can do so indirectly, however, by wrapping such blocks in subsystem blocks that have input or output ports connected to the non-I/O ports.

## Data Type Support

The Configurable Subsystem block accepts and outputs signals of the same types as are accepted or output by the block that it currently represents. The data types may be any supported by Simulink, including fixed-point data types.

## Parameters and Dialog Box

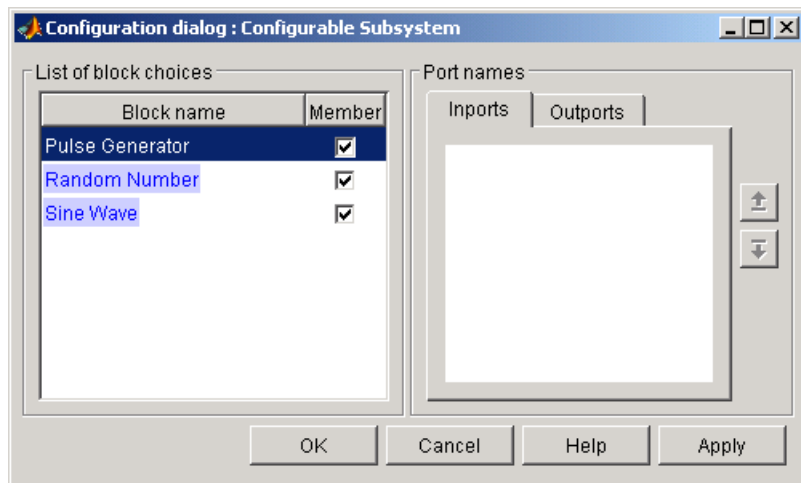

### List of block choices

Select the blocks you want to include as members of the configurable subsystem. You can include user-defined subsystems as blocks.

# Configurable Subsystem

---

## **Port information**

Lists of input and output ports of member blocks. In the case of multiports, you can rearrange selected port positions by clicking the **Up** and **Down** buttons.

**Characteristics** A Configurable Subsystem block has the characteristics of the block that it currently represents. Double-clicking the block opens the dialog box for the block that it currently represents.

**Purpose** Generate constant value

**Library** Sources

### Description

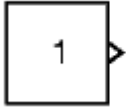

The Constant block generates a real or complex constant value. The block generates scalar (one-element array), vector (1-D array), or matrix (2-D array) output, depending on the dimensionality of the **Constant value** parameter and the setting of the **Interpret vector parameters as 1-D** parameter. Also, the block can generate either a sample-based or frame-based signal, depending on the setting of the **Sampling mode** parameter.

The output of the block has the same dimensions and elements as the **Constant value** parameter. If you specify a vector for this parameter, and you want the block to interpret it as a vector (i.e., a 1-D array), select the **Interpret vector parameters as 1-D** parameter; otherwise, the block treats the **Constant value** parameter as a matrix (i.e., a 2-D array).

### Data Type Support

By default, the Constant block outputs a signal whose data type and complexity are the same as that of the block's **Constant value** parameter. However, you can specify the output to be any data type supported by Simulink, including fixed-point data types.

For a discussion on the data types supported by Simulink, see “Data Types Supported by Simulink” in the “Working with Data” chapter of the Using Simulink documentation.

# Constant

## Parameters and Dialog Box

The **Main** pane of the Constant block dialog appears as follows:

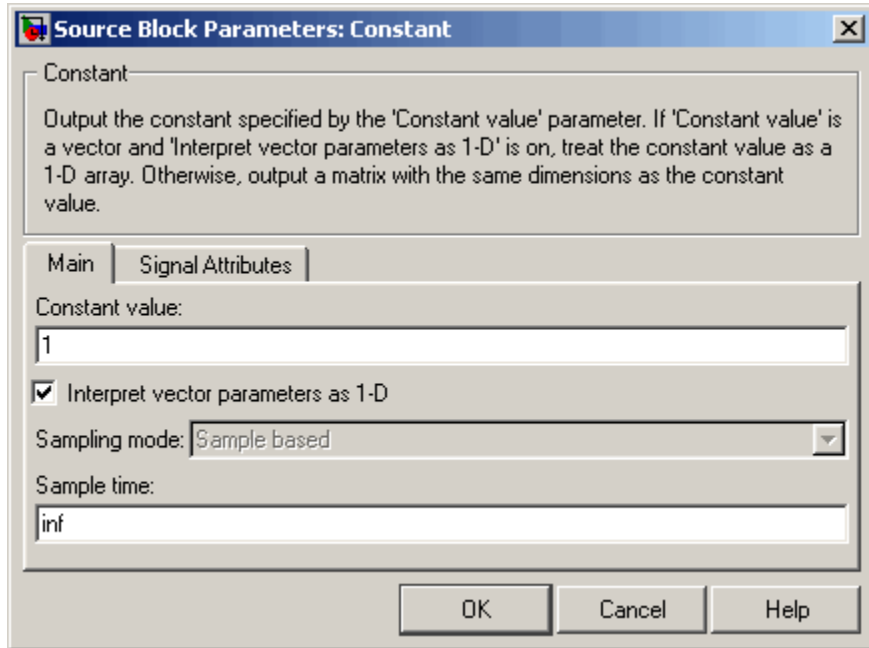

Opening this dialog box causes a running simulation to pause. See “Changing Source Block Parameters During Simulation” in the “Working with Blocks” chapter of the Using Simulink documentation.

### Constant value

Specify the constant value output by the block. You can enter any MATLAB expression in this field, including the Boolean keywords, true or false, that evaluates to a matrix value. The **Constant value** parameter is converted from its data type to the specified output data type offline using round-to-nearest and saturation.

### Interpret vector parameters as 1-D

If you select this check box, the Constant block outputs a vector of length N if the **Constant value** parameter evaluates to an

N-element row or column vector, i.e., a matrix of dimension  $1 \times N$  or  $N \times 1$ . If you uncheck this option, you can interact with the **Sampling mode** parameter. See “Determining the Output Dimensions of Source Blocks” in the “Working with Signals” chapter of the Using Simulink documentation.

### **Sampling mode**

Specify whether the output signal is `Sample` based or `Frame` based. For more information about these types of signals, see “Sample-Based Signals” and “Frame-Based Signals” in the Signal Processing Blockset User’s Guide.

---

**Note** To generate frame-based signals, you must have Signal Processing Blockset installed.

---

### **Sample time**

Specify the interval between times that the Constant block’s output can change during simulation (e.g., as a result of tuning its **Constant value** parameter). The default sample time is `inf`, i.e., the block’s output can never change. This setting speeds simulation and generated code by avoiding the need to recompute the block’s output. See “Specifying Sample Time” in the “How Simulink Works” chapter of the Using Simulink documentation.

The **Signal Attributes** pane of the Constant block dialog appears as follows:

# Constant

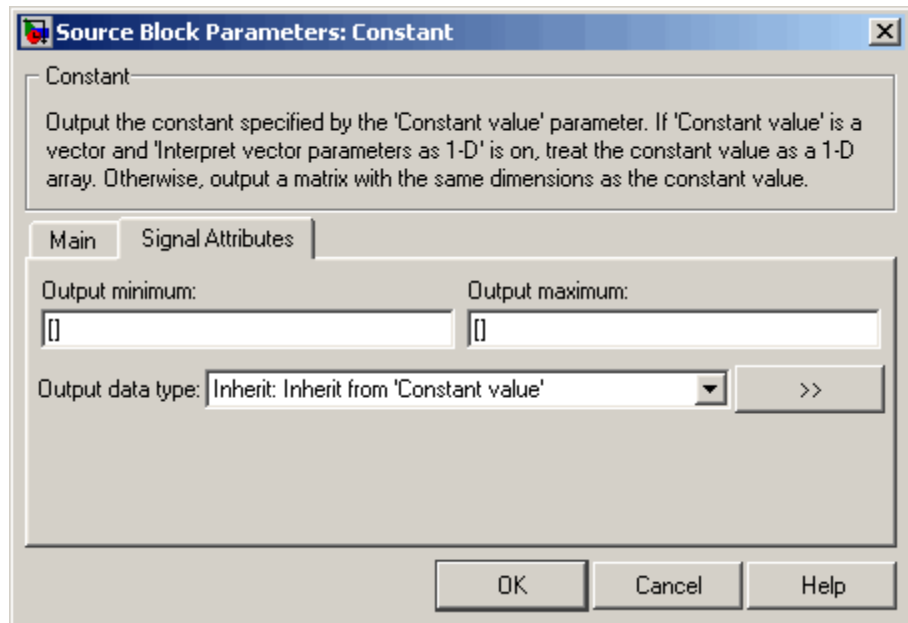

## Output minimum

Specify the minimum value that the block should output. The default value, [ ], is equivalent to  $-\text{Inf}$ . Simulink uses this value to perform:

- Parameter range checking (see “Checking Parameter Values”)
- Simulation range checking (see “Checking Signal Ranges”)
- Automatic scaling of fixed-point data types

## Output maximum

Specify the maximum value that the block should output. The default value, [ ], is equivalent to  $\text{Inf}$ . Simulink uses this value to perform:

- Parameter range checking (see “Checking Parameter Values”)
- Simulation range checking (see “Checking Signal Ranges”)



- Automatic scaling of fixed-point data types

## Output data type

Specify the output data type. You can set it to:

- A rule that inherits a data type, for example, `Inherit: Inherit via back propagation`
- The name of a built-in data type, for example, `single`
- The name of a data type object, for example, a `Simulink.NumericType` object
- An expression that evaluates to a data type, for example, `float('single')`

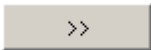
Click the **Show data type assistant** button  to display the **Data Type Assistant**, which helps you set the **Output data type** parameter.

See “Specifying Block Output Data Types” in *Using Simulink* for more information.

## Characteristics

Direct Feedthrough	N/A
Sample Time	Specified in the <b>Sample time</b> parameter
Scalar Expansion	No
Dimensionalized	Yes
Multidimensionalized	Yes
Zero Crossing	No

# Cosine

---

## Purpose

Implement cosine function in fixed-point using lookup table approach that exploits quarter wave symmetry

## Library

Lookup Tables

## Description

The Cosine block is an implementation of the Sine and Cosine block. See [Sine](#) and [Cosine](#) for more information.

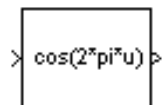

**Purpose** Model discontinuity at zero, with linear gain elsewhere

**Library** Discontinuities

**Description** The Coulomb and Viscous Friction block models Coulomb (static) and viscous (dynamic) friction. The block models a discontinuity at zero and a linear gain otherwise. The offset corresponds to the Coulombic friction; the gain corresponds to the viscous friction. The block is implemented as

$$y = \text{sign}(u) * (\text{Gain} * \text{abs}(u) + \text{Offset})$$

where  $y$  is the output,  $u$  is the input, and  $\text{Gain}$  and  $\text{Offset}$  are block parameters.

The block accepts one input and generates one output. The input can be a scalar, vector, or matrix. If using a vector or matrix input, the offset and gain must have the same dimensions as the input or be scalars. If using a scalar input, the output will be a scalar, vector, or matrix based on the dimensions of the offset and gain. For example, passing a scalar input to the block when using the default offset produces an output vector with four elements.

**Data Type Support** The Coulomb and Viscous Friction block accepts and outputs real signals of type double.

# Coulomb and Viscous Friction

## Parameters and Dialog Box

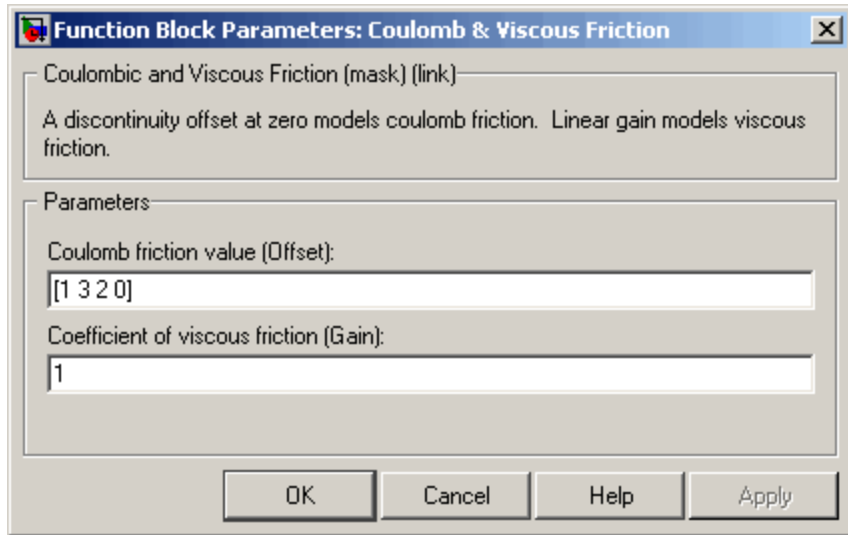

### Coulomb friction value

The offset, applied to all input values. The default is [1 3 2 0].

### Coefficient of viscous friction

The signal gain at nonzero input points. The default is 1.

## Characteristics

Direct Feedthrough	Yes
Sample Time	Inherited from driving block
Scalar Expansion	Yes
Dimensionalized	Yes
Zero Crossing	Yes, at the point where the static friction is overcome

## Purpose

Count up and overflow back to zero after maximum value possible is reached for specified number of bits

## Library

Sources

## Description



The Counter Free-Running block counts up until the maximum possible value,  $2^{N_{\text{bits}}} - 1$ , is reached, where  $N_{\text{bits}}$  is the number of bits. Then the counter overflows to zero, and restarts counting up. The counter is always initialized to zero.

You can specify the number of bits with the **Number of Bits** parameter.

You can specify the sample time with the **Sample time** parameter.

The output is an unsigned integer. If you select the global doubles override, the Counter Free-Running block does not wrap back to zero.

## Data Type Support

The Counter Free-Running block outputs an unsigned integer.

## Parameters and Dialog Box

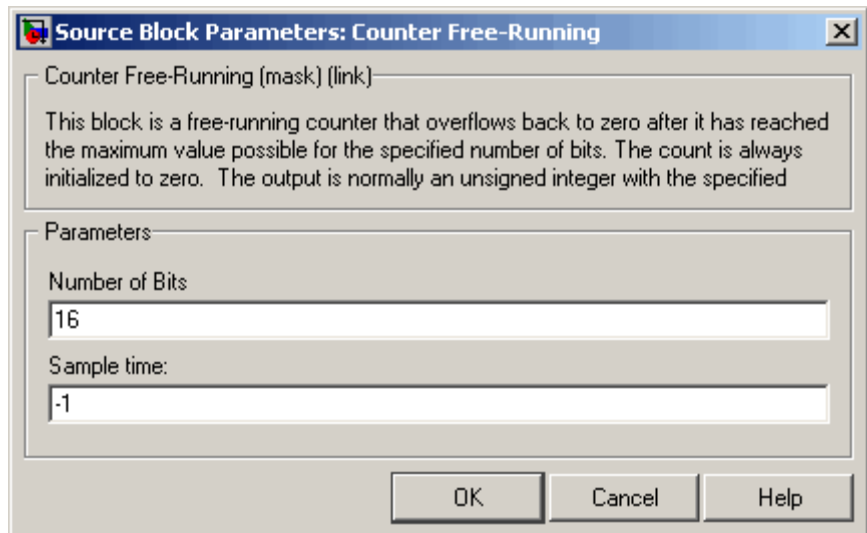

# Counter Free-Running

---

## Number of Bits

Specified number of bits.

## Sample time

Specify the time interval between samples. To inherit the sample time, set this parameter to -1. See “Specifying Sample Time” in the “How Simulink Works” chapter of the Using Simulink documentation.

## Characteristics

Sample Time	Specified in the <b>Sample time</b> parameter
Scalar Expansion	No

## See Also

Counter Limited

**Purpose** Count up and wrap back to zero after outputting specified upper limit

**Library** Sources

## Description



The Counter Limited block counts up until the specified upper limit is reached. Then the counter wraps back to zero, and restarts counting up. The counter is always initialized to zero.

You can specify the upper limit with the **Upper limit** parameter.

You can specify the sample time with the **Sample time** parameter. A **Sample time** of -1 means that the sample time is inherited.

The output is an unsigned integer of 8, 16, or 32 bits, with the smallest number of bits needed to represent the upper limit.

## Data Type Support

The Counter Limited block outputs an unsigned integer.

## Parameters and Dialog Box

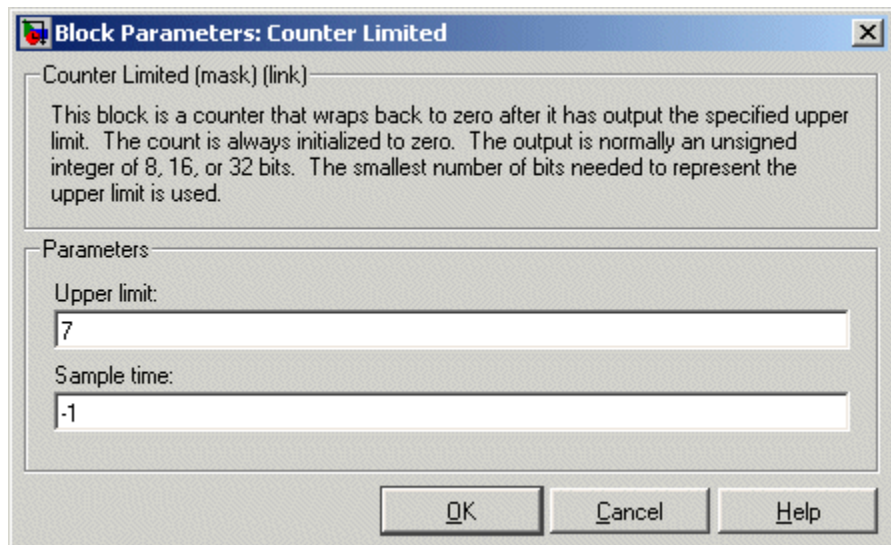

# Counter Limited

---

## Upper limit

Upper limit.

## Sample time

Specify the time interval between samples. To inherit the sample time, set this parameter to -1. See “Specifying Sample Time” in the “How Simulink Works” chapter of the Using Simulink documentation.

## Characteristics

Sample Time	Specified in the <b>Sample time</b> parameter
Scalar Expansion	No

## See Also

Counter Free-Running



**Purpose** Define data store

**Library** Signal Routing

**Description**

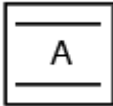

The Data Store Memory block defines and initializes a named shared data store, which is a memory region usable by Data Store Read and Data Store Write blocks with the same data store name.

The location of the Data Store Memory block that defines a data store determines the Data Store Read and Data Store Write blocks that can access the data store:

- If the Data Store Memory block is in the *top-level system*, the data store can be accessed by Data Store Read and Data Store Write blocks located anywhere in the model.
- If the Data Store Memory block is in a *subsystem*, the data store can be accessed by Data Store Read and Data Store Write blocks located in the same subsystem or in any subsystem below it in the model hierarchy.

---

**Note** You can use signal objects in addition to or instead of Data Store Memory blocks to define data stores. See “Working with Data Stores” for more information.

---

You initialize the data store by specifying a scalar value or an array of values in the **Initial value** parameter. The dimensions of the array determine the dimensionality of the data store. Any data written to the data store must have the dimensions designated by the **Initial value** parameter. Otherwise, an error occurs.

# Data Store Memory

---

## **Data Type Support**

The Data Store Memory block stores real or complex signals of any data type supported by Simulink, including fixed-point data types.

For a discussion on the data types supported by Simulink, see “Data Types Supported by Simulink” in the “Working with Data” chapter of the Using Simulink documentation.

## Parameters and Dialog Box

The **Main** pane of the Data Store Memory block dialog appears as follows:

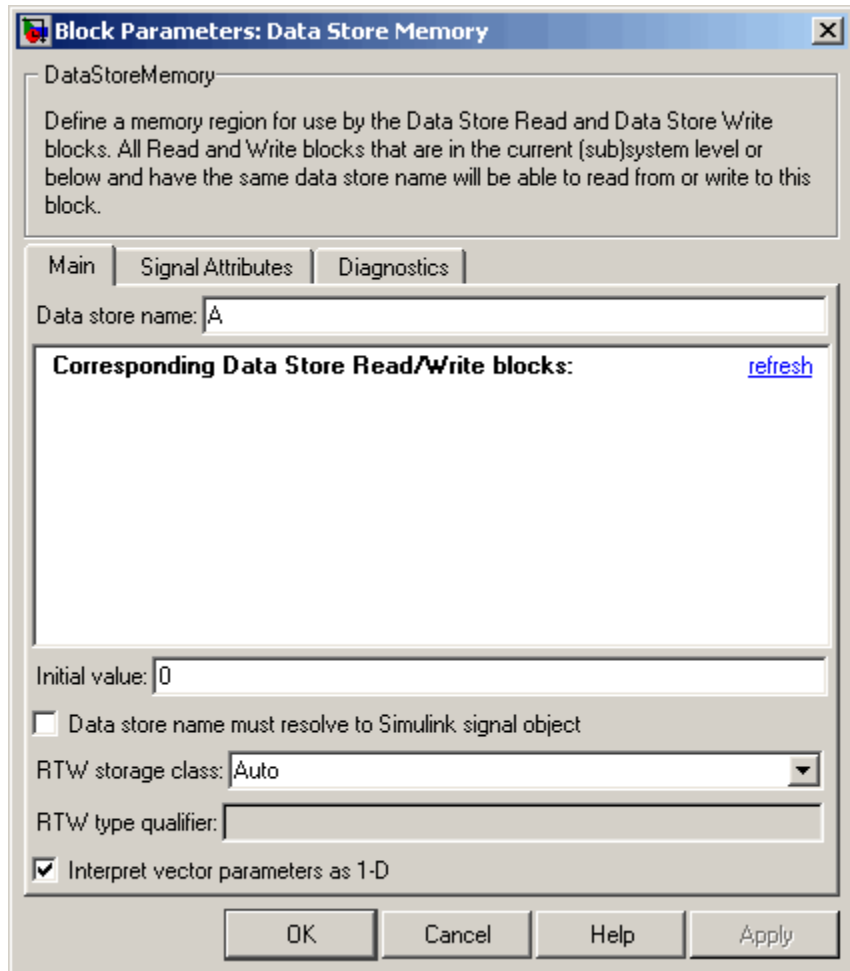

# Data Store Memory

---

## **Data store name**

Specify a name for the data store you are defining with this block. Data Store Read and Data Store Write blocks with the same name will be able to read from and write to the data store initialized by this block.

## **Corresponding Data Store Read blocks**

This parameter lists all the Data Store Read and Data Store Write blocks that have the same data store name as the current block, and that are in the current (sub)system or in any subsystem below it in the model hierarchy. Double-click any entry on this list to highlight the block and bring it to the foreground.

## **Initial value**

Specify the initial value or values of the data store. The dimensions of this value determine the dimensions of data that may be written to the data store.

## **Data store must resolve to Simulink signal object**

Causes Simulink, when compiling the model, to search the model and base workspace for a `Simulink.Signal` object having the same name. If such an object is not found, Simulink halts the compilation and displays an error. Otherwise Simulink compares the attributes of the signal object with the corresponding attributes of the data store memory block. If the block and the object attributes are inconsistent, Simulink halts model compilation and displays an error.

These following parameters pertain to code generation and have no effect during model simulation:

- **Data store name must resolve to Simulink signal object**
- **RTW storage class**
- **RTW type qualifier**

See “Block State Storage and Interfacing” in the Real-Time Workshop® documentation for more information.

## **Interpret vector parameters as 1-D**

If selected and the **Initial value** parameter is specified as a column or row matrix, the data store is initialized to a 1-D array whose elements are equal to the elements of the row or column vector. See “Determining the Output Dimensions of Source Blocks” in the “Working with Signals” chapter of the Using Simulink documentation.

The **Signal Attributes** pane of the Data Store Memory block dialog appears as follows:

# Data Store Memory

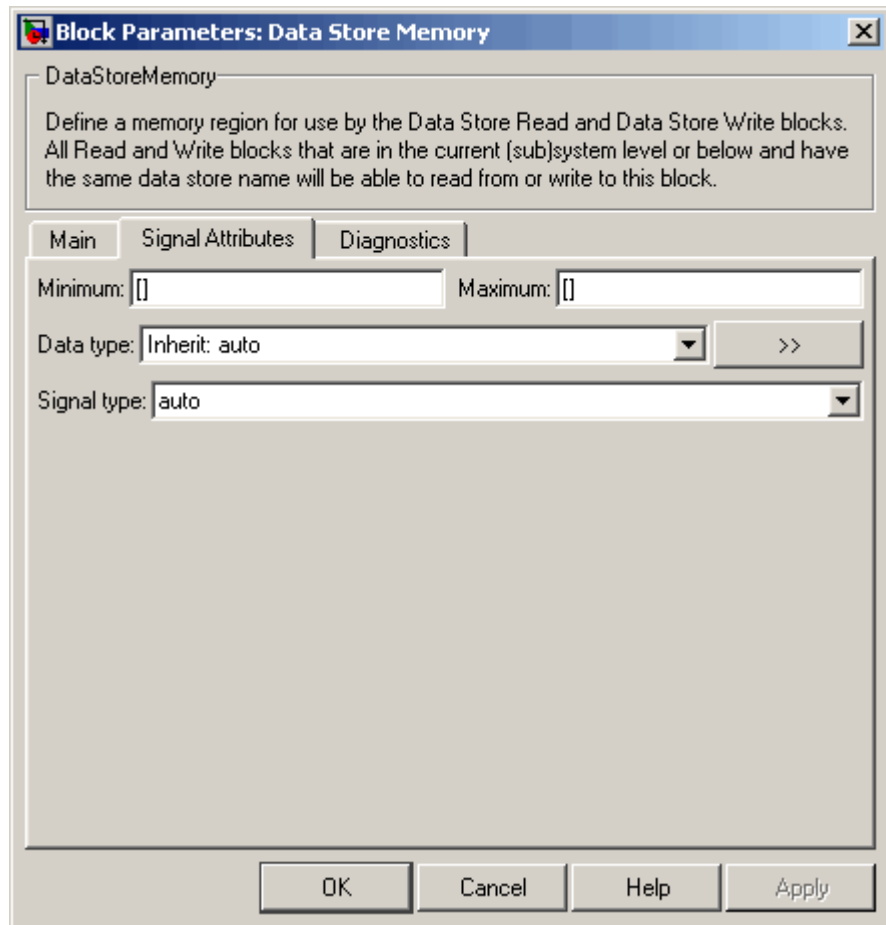

## Minimum

Specify the minimum value that the block should output. The default value, [], is equivalent to  $-\infty$ . Simulink uses this value to perform:

- Parameter range checking (see “Checking Parameter Values”)
- Simulation range checking (see “Checking Signal Ranges”)

- Automatic scaling of fixed-point data types

## Maximum

Specify the maximum value that the block should output. The default value, [], is equivalent to Inf. Simulink uses this value to perform:

- Parameter range checking (see “Checking Parameter Values”)
- Simulation range checking (see “Checking Signal Ranges”)
- Automatic scaling of fixed-point data types

## Data type

Specify the output data type. You can set it to:

- A rule that inherits a data type, for example, `Inherit: auto`
- The name of a built-in data type, for example, `single`
- The name of a data type object, for example, a `Simulink.NumericType` object
- An expression that evaluates to a data type, for example, `float('single')`

Click the **Show data type assistant** button  to display the **Data Type Assistant**, which helps you set the **Data type** parameter.

See “Specifying Block Output Data Types” in *Using Simulink* for more information.

## Signal type

Specify the numeric type, real or complex, of the values stored in the data store.

The **Diagnostics** pane of the Data Store Memory block dialog appears as follows:

# Data Store Memory

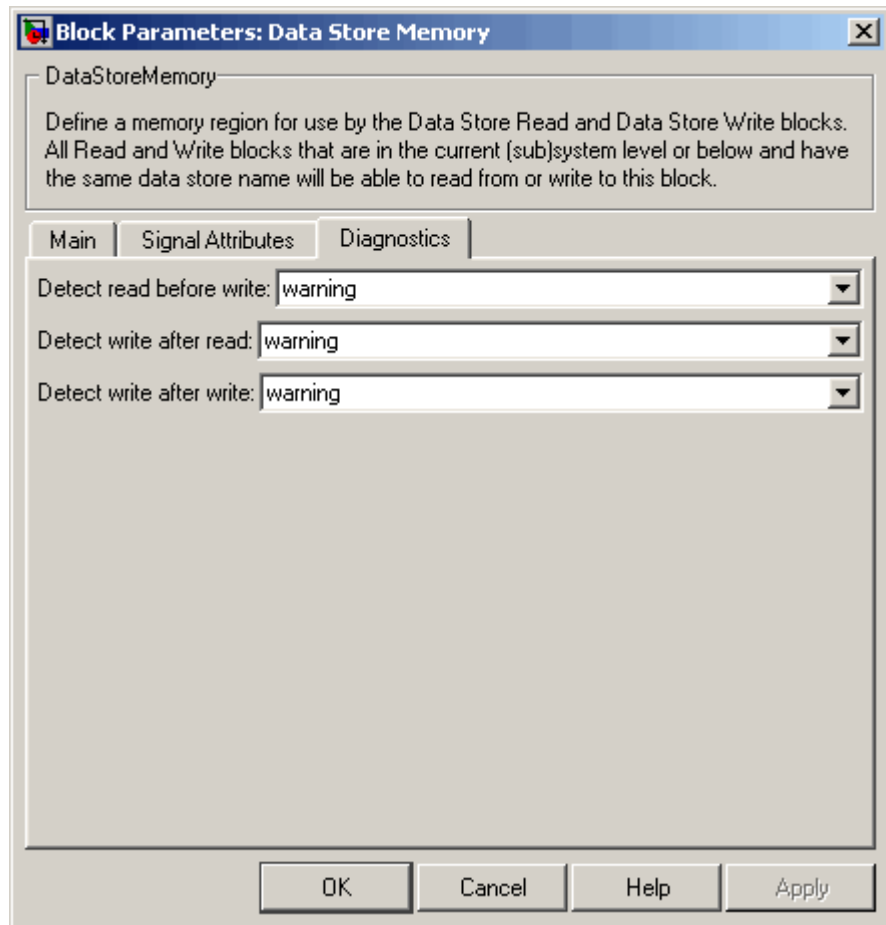

## **Detect read before write**

The model is attempting to read data from this data store without having previously written data into the store in the current time step.



**Detect write after read**

The model is attempting to store data in this data store after previously reading data from it in the current time step.

**Detect write after write**

The model is attempting to store data in this data store twice in succession in the current time step.

**Characteristics**

Sample Time	N/A
Dimensionalized	Yes
Multidimensionalized	Yes

**See Also**

Data Store Read, Data Store Write

# Data Store Read

---

**Purpose** Read data from data store

**Library** Signal Routing

**Description** The Data Store Read block copies data from the named data store to its output.



The data store from which the data is read is determined by the location of the Data Store Memory block or signal object that defines the data store. For more information, see “Working with Data Stores” and Data Store Memory.

More than one Data Store Read block can read from the same data store.

---

**Note** Be careful when setting an execution priority on a Data Store Read block. Make sure that the block reads from the data store after the store is updated by any Data Store Write blocks that write to the store in the same time step.

---

**Data Type Support** The Data Store Read block can output a real or complex signal of any data type supported by Simulink, including fixed-point data types.

For a discussion on the data types supported by Simulink, see “Data Types Supported by Simulink” in the “Working with Data” chapter of the Using Simulink documentation.

## Parameters and Dialog Box

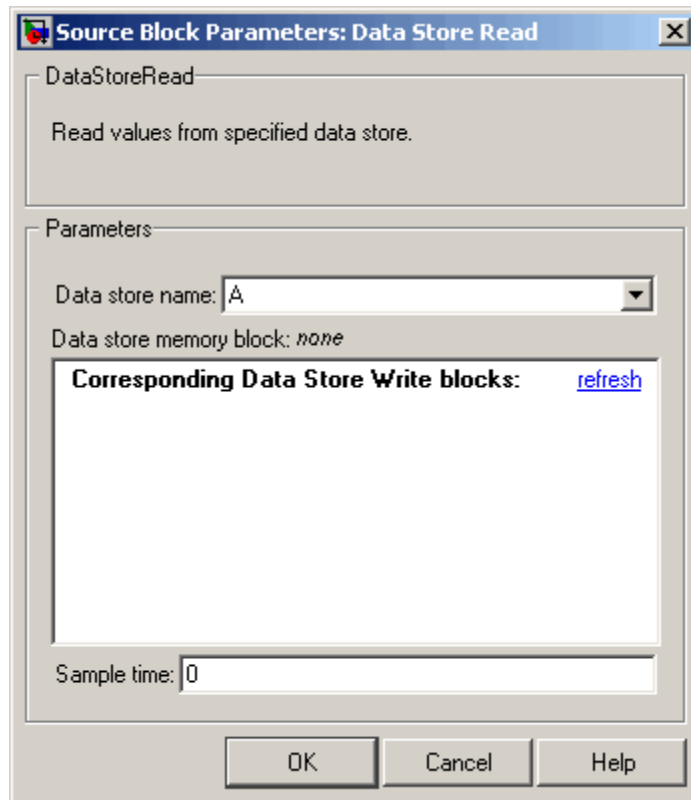

### Data store name

Specifies the name of the data store from which this block reads data. The adjacent pull-down list lists the names of Data Store Memory blocks that exist at the same level in the model as the Data Store Read block or at higher levels. To change the name, select a name from the pull-down list or enter the name directly in the edit field.

When Simulink compiles the model containing this block, Simulink searches the model upwards from this block's level for a Data Store Memory block having the specified data store name.

# Data Store Read

---

If Simulink does not find such a block, it searches the model workspace and the MATLAB workspace for a `Simulink.Signal` object having the same name. If Simulink finds the signal object, it creates a hidden Data Store Memory block at the model's root level having the properties specified by the signal object and an initial value of 0. If Simulink finds neither the Data Store Memory block nor the signal object, it halts the compilation and displays an error.

## Data store memory block

This field lists the Data Store Memory block that initialized the store from which this block reads.

## Data store write blocks

This parameter lists all the Data Store Write blocks with the same data store name as this block that are in the same (sub)system or in any subsystem below it in the model hierarchy. Double-click any entry on this list to highlight the block and bring it to the foreground.

## Sample time

The sample time, which controls when the block reads from the data store. A value of -1 indicates that the sample time is inherited. See "Specifying Sample Time" in the online documentation for more information.

## Characteristics

Sample Time	Specified in the <b>Sample time</b> parameter
Dimensionalized	Yes
Multidimensionalized	Yes

## See Also

Data Store Memory, Data Store Write

**Purpose** Write data to data store

**Library** Signal Routing

**Description** The Data Store Write block copies the value at its input to the named data store.

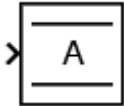

Each write operation performed by a Data Store Write block writes over the data store, replacing the previous contents.

The data store to which this block writes is determined by the location of the Data Store Memory or signal object that defines the data store. For more information, see “Working with Data Stores” and Data Store Memory. The size of the data store is set by the signal object or the Data Store Memory block that defines and initializes the data store. Each Data Store Write block that writes to that data store must write the same amount of data.

More than one Data Store Write block can write to the same data store. However, if two Data Store Write blocks attempt to write to the same data store during the same simulation step, results are unpredictable.

**Data Type Support** The Data Store Write block accepts a real or complex signal of any data type supported by Simulink, including fixed-point data types.

For a discussion on the data types supported by Simulink, see “Data Types Supported by Simulink” in the “Working with Data” chapter of the Using Simulink documentation.

## Parameters and Dialog Box

### Data store name

Specifies the name of the data store to which this block writes data. The adjacent pull-down list lists the names of Data Store Memory blocks that exist at the same level in the model as the Data Store Write block or at higher levels. To change the name, select a name from the pull-down list or enter the name directly in the edit field.

# Data Store Write

---

When Simulink compiles the model containing this block, Simulink searches the model upwards from this block's level for a Data Store Memory block having the specified data store name. If Simulink does not find such a block, it searches the model workspace and the MATLAB workspace for a `Simulink.Signal` object having the same name. If Simulink finds the signal object, it creates a hidden Data Store Memory block at the model's root level having the properties specified by the signal object and an initial value of 0. If Simulink finds neither the Data Store Memory block nor the signal object, it halts the compilation and displays an error.

## Data store memory block

This field lists the Data Store Memory block that initialized the store to which this block writes.

## Data store read blocks

This parameter lists all the Data Store Read blocks with the same data store name as this block that are in the same (sub)system or in any subsystem below it in the model hierarchy. Double-click any entry on this list to highlight the block and bring it to the foreground.

## Sample time

Specify the sample time that controls when the block writes to the data store. A value of -1 indicates that the sample time is inherited. See "Specifying Sample Time" in the online documentation for more information.

## Characteristics

Sample Time	Specified in the <b>Sample time</b> parameter
Dimensionalized	Yes
Multidimensionalized	Yes

## See Also

Data Store Memory, Data Store Read

**Purpose** Convert input signal to specified data type

**Library** Signal Attributes

**Description** The Data Type Conversion block converts an input signal of any Simulink data type to the data type and scaling specified by the block's **Output data type** parameter. The input can be any real- or complex-valued signal. If the input is real, the output is real. If the input is complex, the output is complex.

---

**Note** This block requires that you specify the data type and/or scaling for the conversion. If you want to inherit this information from an input signal, you should use the Data Type Conversion Inherited block.

---

The **Input and output to have equal** parameter controls how the input is processed. The possible values are Real World Value (RWV) and Stored Integer (SI):

- Select Real World Value (RWV) to treat the input as  $V = SQ + B$  where  $S$  is the slope and  $B$  is the bias.  $V$  is used to produce  $Q = (V - B)/S$ , which is stored in the output. This is the default value.
- Select Stored Integer (SI) to treat the input as a stored integer,  $Q$ . The value of  $Q$  is directly used to produce the output. In this mode, the input and output are identical except that the input is a raw integer lacking proper scaling information. Selecting Stored Integer may be useful in these circumstances:
  - If you are generating code for a fixed-point processor, the resulting code only uses integers and does not use floating-point operations.
  - If you want to partition your model based on hardware characteristics. For example, part of your model may involve simulating hardware that produces integers as output.

# Data Type Conversion

---

## Working with Fixed-Point Values Greater than 32 Bits

The MATLAB built-in integer data types are limited to 32 bits. If you want to output fixed-point numbers that range between 33 and 53 bits without loss of precision or range, you should break the number into pieces using the Gain block, and then output the pieces using the Data Type Conversion block to store the value inside a double.

For example, suppose the original signal is an unsigned 128-bit value with default scaling. You can break this signal into four pieces using four parallel Gain blocks configured with the gain and output settings shown below.

Piece	Gain	Output Data Type
1	$2^0$	uint(32) - Least significant 32 bits
2	$2^{-32}$	uint(32)
3	$2^{-64}$	uint(32)
4	$2^{-96}$	uint(32) - Most significant 32 bits

For each Gain block, you must also configure the **Round integer calculations toward** parameter to Floor, and the **Saturate on integer overflow** check box must be cleared.

## Data Type Support

The Data Type Conversion block handles any data type supported by Simulink, including fixed-point data types.

For a discussion on the data types supported by Simulink, see “Data Types Supported by Simulink” in the “Working with Data” chapter of the Using Simulink documentation.



## Parameters and Dialog Box

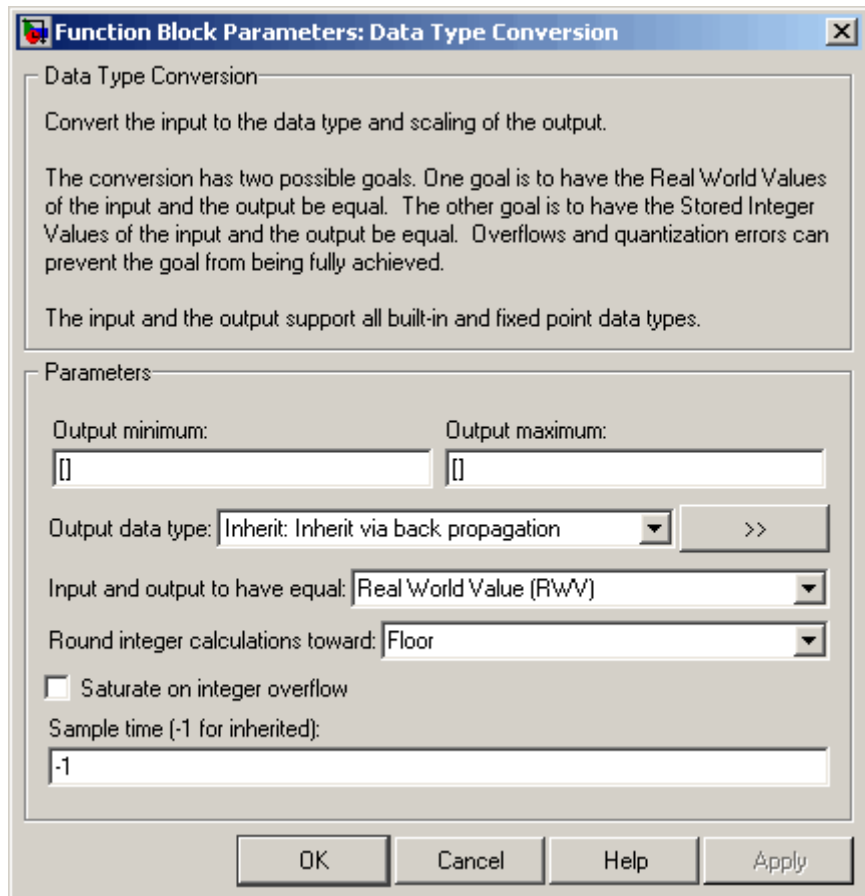

### Output minimum

Specify the minimum value that the block should output. The default value, [ ], is equivalent to  $-\text{Inf}$ . Simulink uses this value to perform:

- Simulation range checking (see “Checking Signal Ranges”)
- Automatic scaling of fixed-point data types

# Data Type Conversion

---

## Output maximum

Specify the maximum value that the block should output. The default value, [], is equivalent to Inf. Simulink uses this value to perform:

- Simulation range checking (see “Checking Signal Ranges”)
- Automatic scaling of fixed-point data types

## Output data type

Specify the output data type. You can set it to:

- A rule that inherits a data type, for example, `Inherit: Inherit via back propagation`
- The name of a built-in data type, for example, `single`
- The name of a data type object, for example, a `Simulink.NumericType` object
- An expression that evaluates to a data type, for example, `float('single')`

Click the **Show data type assistant** button  to display the **Data Type Assistant**, which helps you set the **Output data type** parameter.

See “Specifying Block Output Data Types” in *Using Simulink* for more information.

## Lock output scaling against changes by the autoscaling tool

Select to lock scaling of outputs. This parameter is visible only if you enter an expression for the **Output data type** parameter.

## Input and output to have equal

Specify whether the Real World Value (RWV) or the Stored Integer (SI) of the input and output should be the same.

## Round integer calculations toward

Select the rounding mode for fixed-point operations.

## Saturate on integer overflow

Select to have overflows saturate.

## Sample time (-1 for inherited)

Specify the time interval between samples. To inherit the sample time, set this parameter to -1. See “Specifying Sample Time” in the “How Simulink Works” chapter of the Using Simulink documentation.

## Examples

### Example 1 – Real World Values Versus Stored Integers

This example uses the Data Type Conversion block to help you understand the difference between a real-world value and a stored integer. Consider the two fixed-point models shown below.

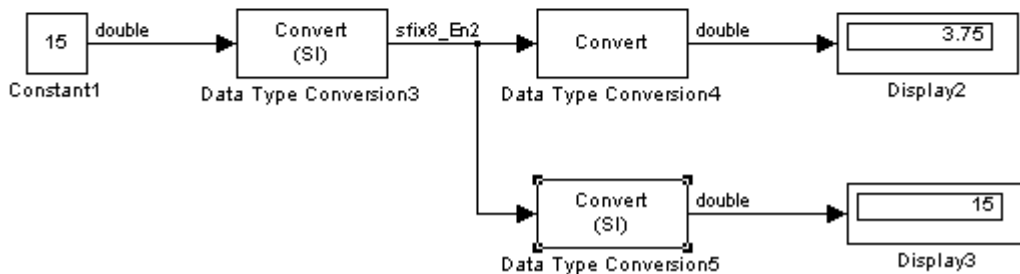
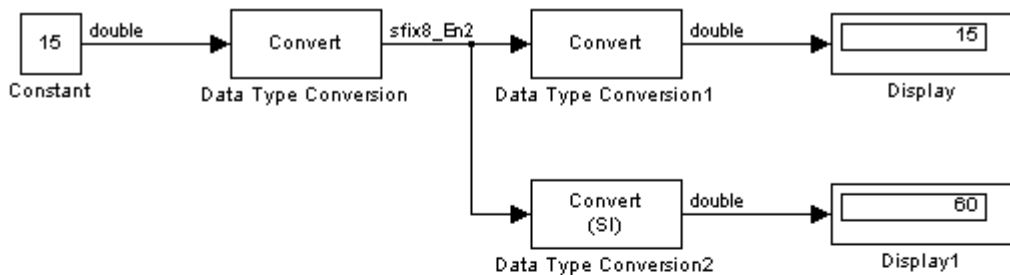

# Data Type Conversion

---

In the top model, the Data Type Conversion block treats the input as a real-world value, and maps that value to an 8-bit signed generalized fixed-point data type with a scaling of  $2^{-2}$ . When the value is then output from the Data Type Conversion1 block as a real-world value, the scaling and data type information is retained and the output value is 001111.00, or 15. When the value is output from the Data Type Conversion2 block as a stored integer, the scaling and data type information is not retained and the stored integer is interpreted as 00111100, or 60.

In the bottom model, the Data Type Conversion3 block treats the input as a stored integer, and the data type and scaling information is not applied. When the value is then output from the Data Type Conversion4 block as a real-world value, the scaling and data type information is applied to the stored integer, and the output value is 000011.11, or 3.75. When the value is output from the Data Type Conversion5 block as a stored integer, you get back the original input value of 15.

## **Example 2 – Real World Values and Stored Integers in Summations**

The model shown below illustrates how a summation operation applies to real-world values and stored integers, and how scaling information is dealt with in generated code.

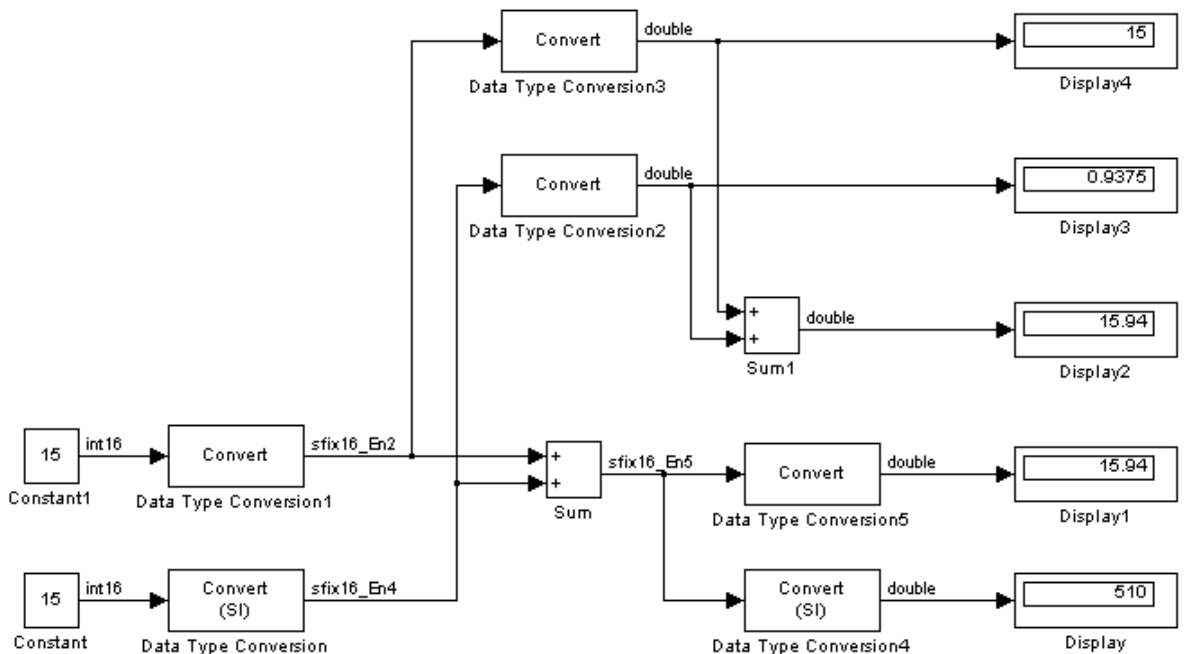

Note that the summation operation produces the correct result when the Data Type Conversion (2 or 5) block outputs a real-world value. This is because the specified scaling information is applied to the stored integer value. However, when the Data Type Conversion4 block outputs a stored integer value, then the summation operation produces an unexpected result due to the absence of scaling information.

If you generate code for the above model, then the code captures the appropriate scaling information. The code for the Sum block is shown below. The inputs to this block are tagged with the specified scaling information so that the necessary shifts are performed for the summation operation.

```
/* Sum Block: <Root>/Sum
 *
 * y = u0 + u1
```

# Data Type Conversion

---

```
*
* Input0 Data Type: Fixed Point S16 2^-2
* Input1 Data Type: Fixed Point S16 2^-4
* Output0 Data Type: Fixed Point S16 2^-5
*
* Round Mode: Floor
* Saturation Mode: Wrap
*
*/
sum = ((in1) << 3);
```

```
sum += ((in2) << 1);
```

## Characteristics

Direct Feedthrough	Yes
Sample Time	Inherited from driving block
Scalar Expansion	N/A
Dimensionalized	Yes
Multidimensionalized	Yes
Zero Crossing	No

## See Also

Data Type Conversion Inherited

## Purpose

Convert from one data type to another using inherited data type and scaling

## Library

Signal Attributes

## Description



The Data Type Conversion Inherited block forces dissimilar data types to be the same. The first input is used as the reference signal and the second input is converted to the reference type by inheriting the data type and scaling information. (See “Changing the Orientation of a Block” in Using Simulink for a description of the port order for various block orientations.) Either input is scalar expanded such that the output has the same width as the widest input.

Inheriting the data type and scaling provides these advantages:

- It makes reusing existing models easier.
- It allows you to create new fixed-point models with less effort since you can avoid the detail of specifying the associated parameters.

## Data Type Support

The Data Type Conversion Inherited block handles any data type supported by Simulink, including fixed-point data types.

For a discussion on the data types supported by Simulink, see “Data Types Supported by Simulink” in the “Working with Data” chapter of the Using Simulink documentation.

# Data Type Conversion Inherited

## Parameters and Dialog Box

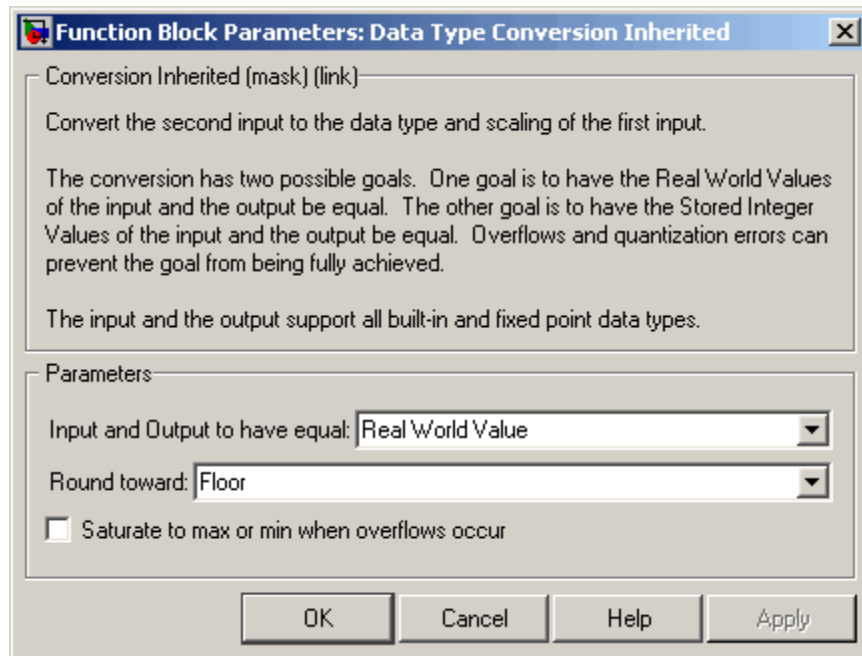

### Input and Output to have equal

Specify whether the Real World Value (RWV) or the Stored Integer (SI) of the input and output should be the same. Refer to Description in the Data Type Conversion block reference page for more information about these choices.

### Round toward

Select the rounding mode for fixed-point operations.

### Saturate to max or min when overflows occur

Select to have overflows saturate.

## Characteristics

Direct Feedthrough	Yes
--------------------	-----

## See Also

Data Type Conversion



**Purpose** Force all inputs to same data type

**Library** Signal Attributes

## Description

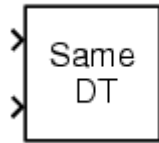

The Data Type Duplicate block forces all inputs to have exactly the same data type. Other attributes of input signals, such as dimension, complexity, and sample time, are completely independent.

You can use the Data Type Duplicate block to check for consistency of data types among blocks. If all signals do not have the same data type, the block returns an error message.

The Data Type Duplicate block is typically used such that one signal to the block controls the data type for all other blocks. The other blocks are set to inherit their data types via backpropagation.

The block is also used in a user created library. These library blocks can be placed in any model, and the data type for all library blocks are configured according to the usage in the model. To create a library block with more complex data type rules than duplication, use the Data Type Propagation block.

## Data Type Support

The Data Type Duplicate block accepts signals of any data type supported by Simulink, including fixed-point data types.

# Data Type Duplicate

## Parameters and Dialog Box

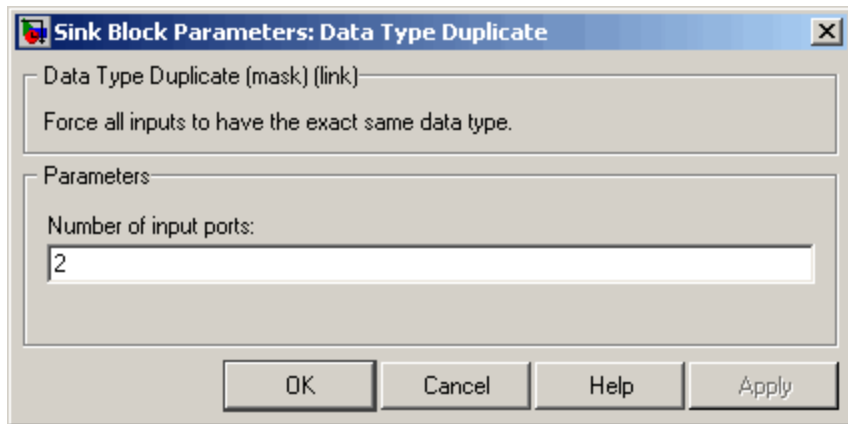

### Number of input ports

Number of input ports.

## Characteristics

Scalar Expansion	Yes
States	0

**Purpose** Set data type and scaling of propagated signal based on information from reference signals

**Library** Signal Attributes

## Description



The Data Type Propagation block allows you to control the data type and scaling of signals in your model. You can use this block in conjunction with fixed-point blocks that have their **Specify data type and scaling** parameter configured to *Inherit* via back propagation.

The block has three inputs: Ref1 and Ref2 are the reference inputs, while the Prop input back propagates the data type and scaling information gathered from the reference inputs. This information is then passed on to other fixed-point blocks.

The block provides you with many choices for propagating data type and scaling information. For example, you can:

- Use the number of bits from the Ref1 reference signal, or use the number of bits from widest reference signal.
- Use the range from the Ref2 reference signal, or use the range of the reference signal with the greatest range.
- Use a bias of zero, regardless of the biases used by the reference signals.
- Use the precision of the reference signal with the least precision.

You specify how data type information is propagated with the **Propagated data type** parameter list. If the parameter list is configured as *Specify* via dialog, then you manually specify the data type via the **Propagated data type** edit field. If the parameter list is configured as *Inherit* via propagation rule, then you must use the parameters described in “Parameters and Dialog Box” on page 2-160.

You specify how scaling information is propagated with the **Propagated scaling** parameter list. If the parameter list is configured as *Specify* via dialog, then you manually specify the scaling via the **Propagated scaling** edit field. If the parameter list is configured as *Inherit* via

# Data Type Propagation

---

propagation rule, then you must use the parameters described in “Parameters and Dialog Box” on page 2-160.

After you use the information from the reference signals, you can apply a second level of adjustments to the data type and scaling by using individual multiplicative and additive adjustments. This flexibility has a variety of uses. For example, if you are targeting a DSP, then you can configure the block so that the number of bits associated with a MAC (multiply and accumulate) operation is twice as wide as the input signal, and has a certain number of guard bits added to it.

The Data Type Propagation block also provides a mechanism to force the computed number of bits to a useful value. For example, if you are targeting a 16-bit micro, then the target C compiler is likely to support sizes of only 8 bits, 16 bits, and 32 bits. The block will force these three choices to be used. For example, suppose the block computes a data type size of 24 bits. Since 24 bits is not directly usable by the target chip, the signal is forced up to 32 bits, which is natively supported.

There is also a method for dealing with floating-point reference signals. This makes it easier to create designs that are easily retargeted from fixed-point chips to floating-point chips or vice versa.

The Data Type Propagation block allows you to set up libraries of useful subsystems that will be properly configured based on the connected signals. Without this data type propagation process, a subsystem that you use from a library will almost certainly not work as desired with most integer or fixed-point signals, and manual intervention to configure the data type and scaling would be required. This block can eliminate the manual intervention in many situations.

## Precedence Rules

The precedence of the dialog box parameters decreases from top to bottom. Additionally:

- Double-precision reference inputs have precedence over all other data types.

- Single-precision reference inputs have precedence over integer and fixed-point data types.
- Multiplicative adjustments are carried out before additive adjustments.
- The number of bits is determined before the precision or positive range is inherited from the reference inputs.

## Data Type Support

The Data Type Propagation block accepts signals of any data type supported by Simulink, including fixed-point data types.

# Data Type Propagation

## Parameters and Dialog Box

The **Propagated type** pane of the Data Type Propagation block dialog appears as follows:

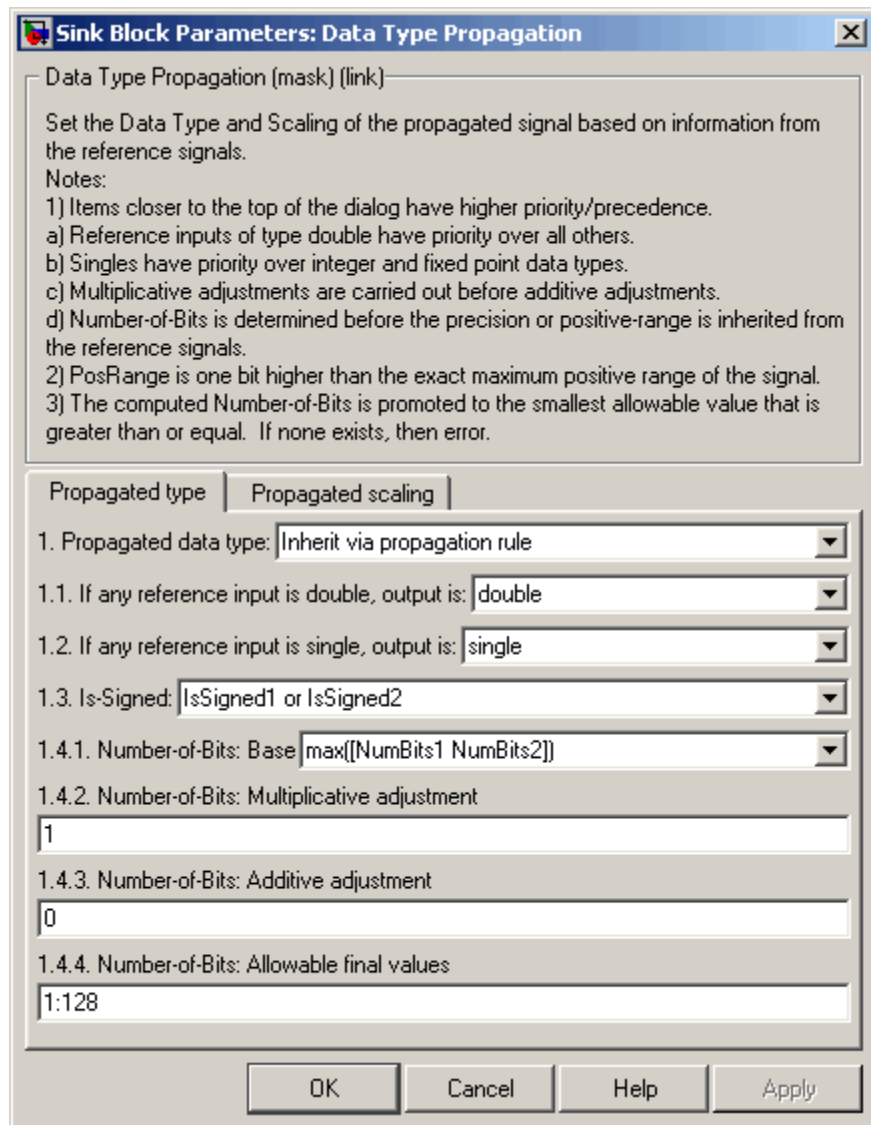

## Propagated data type

Use the parameter list to propagate the data type via the dialog box, or inherit the data type from the reference signals. Use the edit field to specify the data type via the dialog box.

## If any reference input is double, output is

Specify single or double. This parameter makes it easier to create designs that are easily retargeted from fixed-point chips to floating-point chips or vice versa.

This parameter is only visible if `Inherit` via propagation rule is selected for the **Propagated data type** parameter list.

## If any reference input is single, output is

Specify single or double. This parameter makes it easier to create designs that are easily retargeted from fixed-point chips to floating-point chips or visa versa.

This parameter is only visible if `Inherit` via propagation rule is selected for the **Propagated data type** parameter list.

## Is-Signed

Specify the sign of Prop as one of the following values:

Parameter Value	Description
IsSigned1	Prop is a signed data type if Ref1 is a signed data type.
IsSigned2	Prop is a signed data type if Ref2 is a signed data type.
IsSigned1 or IsSigned2	Prop is a signed data type if either Ref1 or Ref2 are signed data types.
TRUE	Ref1 and Ref2 are ignored, and Prop is always a signed data type.
FALSE	Ref1 and Ref2 are ignored, and Prop is always an unsigned data type.

# Data Type Propagation

---

For example, if the Ref1 signal is `ufix(16)`, the Ref2 signal is `sfix(16)`, and the **Is-Signed** parameter is `IsSigned1` or `IsSigned2`, then Prop is forced to be a signed data type.

This parameter is only visible if `Inherit` via propagation rule is selected for the **Propagated data type** parameter list.

## Number-of-bits: Base

Specify the number of bits used by Prop for the base data type as one of the following values:

Parameter Value	Description
<code>NumBits1</code>	The number of bits for Prop is given by the number of bits for Ref1.
<code>NumBits2</code>	The number of bits for Prop is given by the number of bits for Ref2.
<code>max([NumBits1 NumBits2])</code>	The number of bits for Prop is given by the reference signal with largest number of bits.
<code>min([NumBits1 NumBits2])</code>	The number of bits for Prop is given by the reference signal with smallest number of bits.
<code>NumBits1+NumBits2</code>	The number of bits for Prop is given by the sum of the reference signal bits.

Refer to Targeting an Embedded Processor in the *Simulink Fixed Point User's Guide* documentation for more information about the base data type.

This parameter is only visible if `Inherit` via propagation rule is selected for the **Propagated data type** parameter list.



## **Number-of-bits: Multiplicative adjustment**

Specify the number of bits used by Prop by including a multiplicative adjustment. For example, suppose you want to guarantee that the number of bits associated with a multiply and accumulate (MAC) operation is twice as wide as the input signal. To do this, you configure this parameter to the value 2.

This parameter is only visible if Inherit via propagation rule is selected for the **Propagated data type** parameter list.

## **Number-of-bits: Additive adjustment**

Specify the number of bits used by Prop by including an additive adjustment. For example, if you are performing multiple additions during a MAC operation, the result may overflow. To prevent overflow, you can associate guard bits with the propagated data type. To associate four guard bits, you specify the value 4.

This parameter is only visible if Inherit via propagation rule is selected for the **Propagated data type** parameter list.

## **Number-of-bits: Allowable final values**

Force the computed number of bits used by Prop to a useful value. For example, if you are targeting a processor that supports only 8, 16, and 32 bits, then you configure this parameter to [8, 16, 32]. The block always propagates the smallest specified value that fits. If you want to allow all fixed-point data types, you would specify the value 1:128.

This parameter is only visible if Inherit via propagation rule is selected for the **Propagated data type** parameter list.

The **Propagated scaling** pane of the Data Type Propagation block dialog appears as follows:

# Data Type Propagation

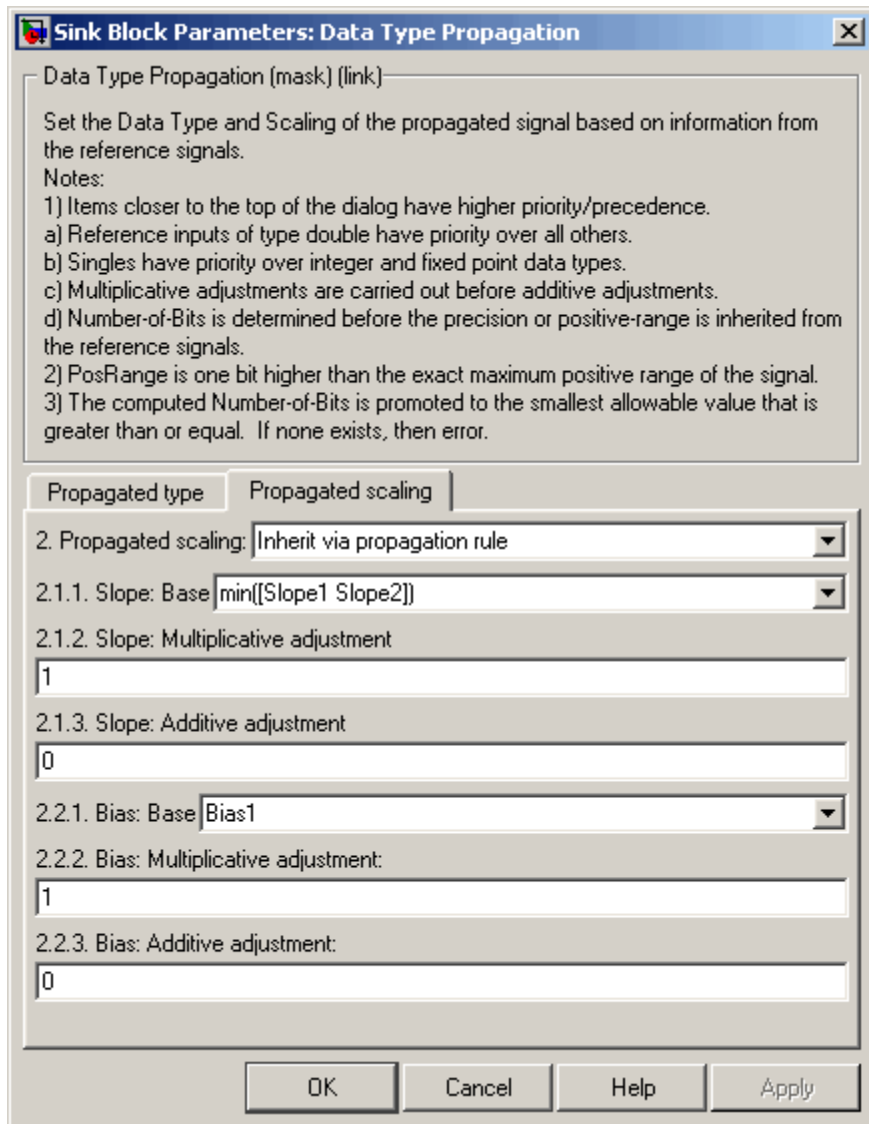

## Propagated scaling

Use the parameter list to propagate the scaling via the dialog box, inherit the scaling from the reference signals, or calculate the scaling to obtain best precision.

## Propagated scaling: Slope or [Slope Bias]

Specify the scaling as either a slope or a slope and bias.

This parameter is only visible if Specify via dialog is selected for the **Propagated scaling** parameter list.

## Values used to determine best precision scaling

Specify any values to be used to constrain the precision, such as the upper and lower limits on the propagated input. Based on the data type, the scaling will automatically be selected such that these values can be represented with no overflow error and minimum quantization error.

This parameter is only visible if Obtain via best precision is selected for the **Propagated scaling** parameter list.

## Slope: Base

Specify the slope used by Prop for the base data type as one of the following values:

Parameter Value	Description
Slope1	The slope of Prop is given by the slope of Ref1.
Slope2	The slope of Prop is given by the slope of Ref2.
max([Slope1 Slope2])	The slope of Prop is given by the maximum slope of the reference signals.
min([Slope1 Slope2])	The slope of Prop is given by the minimum slope of the reference signals.

# Data Type Propagation

---

Parameter Value	Description
$Slope1 * Slope2$	The slope of Prop is given by the product of the reference signal slopes.
$Slope1 / Slope2$	The slope of Prop is given by the ratio of the Ref1 slope to the Ref2 slope.
PosRange1	The range of Prop is given by the range of Ref1.
PosRange2	The range of Prop is given by the range of Ref2.
$\max([PosRange1, PosRange2])$	The range of Prop is given by the maximum range of the reference signals.
$\min([PosRange1, PosRange2])$	The range of Prop is given by the minimum range of the reference signals.
$PosRange1 * PosRange2$	The range of Prop is given by the product of the reference signal ranges.
$PosRange1 / PosRange2$	The range of Prop is given by the ratio of the Ref1 range to the Ref2 range.

You control the precision of Prop with Slope1 and Slope2, and you control the range of Prop with PosRange1 and PosRange2. Additionally, PosRange1 and PosRange2 are one bit higher than the maximum positive range of the associated reference signal.

This parameter is only visible if Inherit via propagation rule is selected for the **Propagated scaling** parameter list.

### **Slope: Multiplicative adjustment**

Specify the slope used by Prop by including a multiplicative adjustment. For example, if you want 3 bits of additional precision (with a corresponding decrease in range), the multiplicative adjustment is  $2^{-3}$ .

This parameter is only visible if `Inherit` via propagation rule is selected for the **Propagated scaling** parameter list.

## Slope: Additive adjustment

Specify the slope used by Prop by including an additive adjustment. An additive slope adjustment is often not needed. The most likely use is to set the multiplicative adjustment to 0, and set the additive adjustment to force the final slope to a specified value.

This parameter is only visible if `Inherit` via propagation rule is selected for the **Propagated scaling** parameter list.

## Bias: Base

Specify the bias used by Prop for the base data type. The parameter values are described below.

Parameter Value	Description
Bias1	The bias of Prop is given by the bias of Ref1.
Bias2	The bias of Prop is given by the bias of Ref2.
$\max([\text{Bias1}, \text{Bias2}])$	The bias of Prop is given by the maximum bias of the reference signals.
$\min([\text{Bias1}, \text{Bias2}])$	The bias of Prop is given by the minimum bias of the reference signals.
$\text{Bias1} * \text{Bias2}$	The bias of Prop is given by the product of the reference signal biases.
$\text{Bias1} / \text{Bias2}$	The bias of Prop is given by the ratio of the Ref1 bias to the Ref2 bias.
$\text{Bias1} + \text{Bias2}$	The bias of Prop is given by the sum of the reference biases.
$\text{Bias1} - \text{Bias2}$	The bias of Prop is given by the difference of the reference biases.

# Data Type Propagation

---

This parameter is only visible if Inherit via propagation rule is selected for the **Propagated scaling** parameter list.

**Bias: Multiplicative adjustment**

Specify the bias used by Prop by including a multiplicative adjustment.

This parameter is only visible if Inherit via propagation rule is selected for the **Propagated scaling** parameter list.

**Bias: Additive adjustment**

Specify the bias used by Prop by including an additive adjustment.

If you want to guarantee that the bias associated with Prop is zero, you should configure both the multiplicative adjustment and the additive adjustment to 0.

This parameter is only visible if Inherit via propagation rule is selected for the **Propagated scaling** parameter list.

**Characteristics**

Direct Feedthrough	Yes
Scalar Expansion	Yes

**Purpose** Remove scaling and map to built in integer

**Library** Signal Attributes

## Description

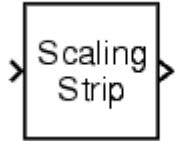

The Scaling Strip block strips the scaling off a fixed point signal. It maps the input data type to the smallest built in data type that has enough data bits to hold the input. The stored integer value of the input is the value of the output. The output always has nominal scaling (slope = 1.0 and bias = 0.0), so the output does not make a distinction between real world value and stored integer value.

## Data Type Support

The Data Type Scaling Strip block accepts signals of any data type supported by Simulink, including fixed-point data types.

## Parameters and Dialog Box

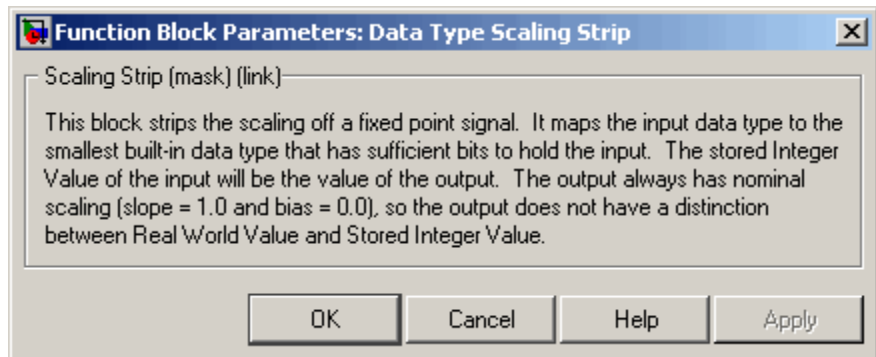

## Characteristics

Direct Feedthrough	Yes
Scalar Expansion	Yes

# Dead Zone

---

**Purpose** Provide region of zero output

**Library** Discontinuities

## Description



The Dead Zone block generates zero output within a specified region, called its dead zone. The lower and upper limits of the dead zone are specified as the **Start of dead zone** and **End of dead zone** parameters. The block output depends on the input and dead zone:

- If the input is within the dead zone (greater than the lower limit and less than the upper limit), the output is zero.
- If the input is greater than or equal to the upper limit, the output is the input minus the upper limit.
- If the input is less than or equal to the lower limit, the output is the input minus the lower limit.

This sample model uses lower and upper limits of -0.5 and +0.5, with a sine wave as input.

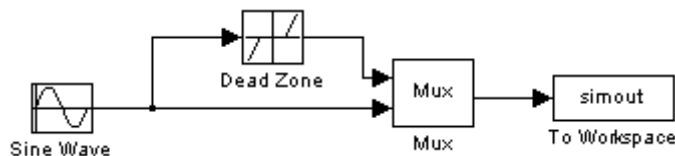

This plot shows the effect of the Dead Zone block on the sine wave. While the input (the sine wave) is between -0.5 and 0.5, the output is zero.



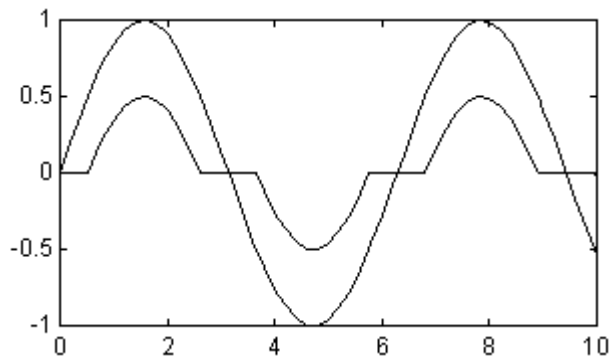

## Data Type Support

The Dead Zone block accepts and outputs a real signal of any data type supported by Simulink, except Boolean. The Dead Zone block supports fixed-point data types.

For a discussion on the data types supported by Simulink, see “Data Types Supported by Simulink” in the “Working with Data” chapter of the Using Simulink documentation.

# Dead Zone

## Parameters and Dialog Box

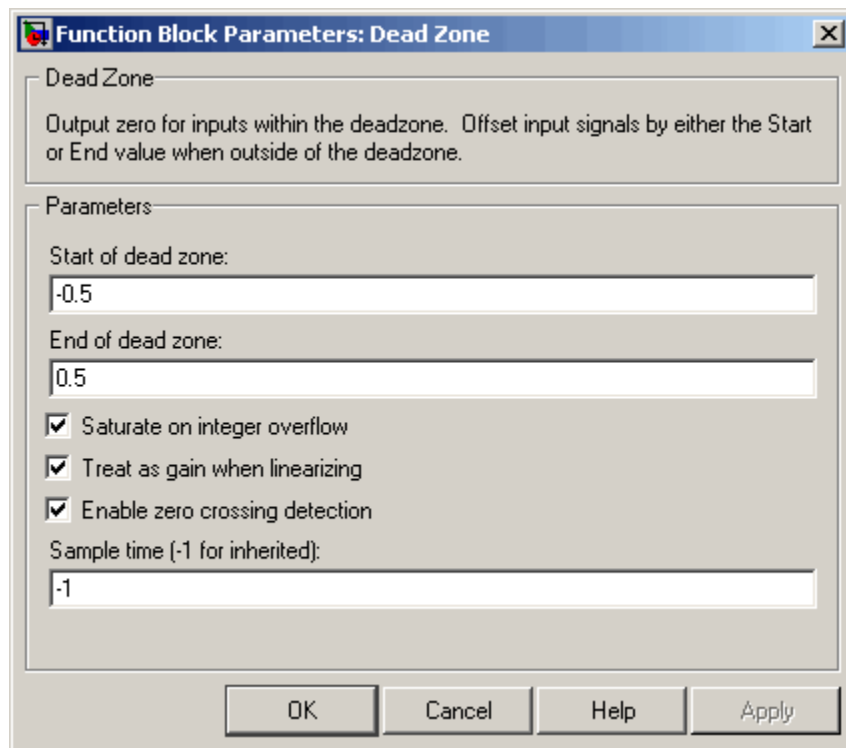

### Start of dead zone

Specify the lower limit of the dead zone. The default is -0.5.

### End of dead zone

Specify the upper limit of the dead zone. The default is 0.5.

### Saturate on integer overflow

Select to have overflows saturate.

### Treat as gain when linearizing

The linearization commands in Simulink treat this block as a gain in state space. Select this option to cause the commands to treat the gain as 1; otherwise, the commands treat the gain as 0.

## **Enable zero crossing detection**

Select to enable zero crossing detection to detect when the limits are reached. For more information, see Zero Crossing Detection in the “How Simulink Works” chapter of the Using Simulink documentation.

## **Sample time (-1 for inherited)**

Specify the time interval between samples. To inherit the sample time, set this parameter to -1. See Specifying Sample Time in the “How Simulink Works” chapter of the Using Simulink documentation.

## **Characteristics**

Direct Feedthrough	Yes
Sample Time	Specified in the <b>Sample time</b> parameter
Scalar Expansion	Yes, of parameters
Dimensionalized	Yes
Zero Crossing	Yes, if enabled

## **See Also**

Dead Zone Dynamic

# Dead Zone Dynamic

**Purpose** Set inputs within bounds to zero

**Library** Discontinuities

## Description

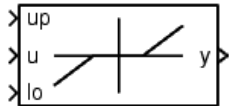

The Dead Zone Dynamic block dynamically bounds the range of the input signal, providing a region of zero output. The bounds change according to the upper and lower limit input signals where

- The input within the bounds is set to zero.
- The input below the lower limit is shifted down by the lower limit.
- The input above the upper limit is shifted down by the upper limit.

The input for the upper limit is the up port, and the input for the lower limit is the lo port.

## Data Type Support

The Dead Zone Dynamic block accepts signals of any data type supported by Simulink, including fixed-point data types.

## Parameters and Dialog Box

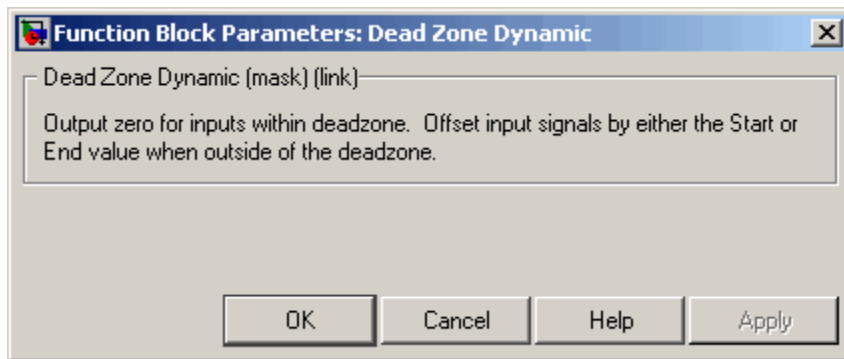

## Characteristics

Direct Feedthrough	Yes
Scalar Expansion	Yes

## **See Also**

Dead Zone

# Decrement Real World

---

**Purpose** Decrease real world value of signal by one

**Library** Additional Math & Discrete / Additional Math: Increment - Decrement

**Description** The Decrement Real World block decreases the real world value of the signal by one. Overflows always wrap.

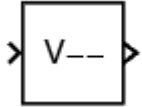

**Data Type Support** The Decrement Real World block accepts signals of any data type supported by Simulink, including fixed-point data types.

## Parameters and Dialog Box

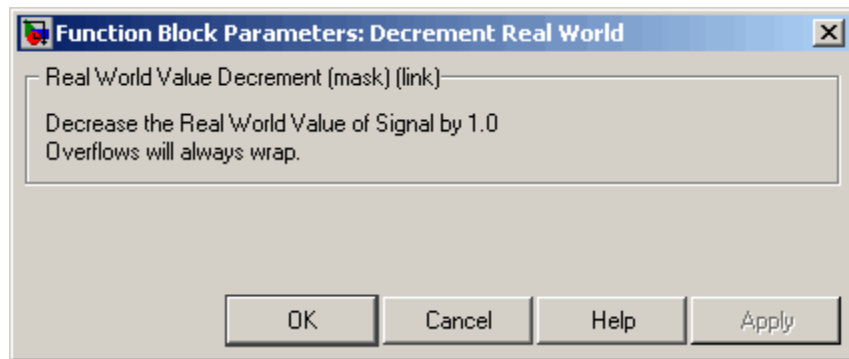

<b>Characteristics</b>	Direct Feedthrough	Yes
	Scalar Expansion	No

**See Also** Decrement Stored Integer, Decrement Time To Zero, Decrement To Zero, Increment Real World

# Decrement Stored Integer

## Purpose

Decrease stored integer value of signal by one

## Library

Additional Math & Discrete / Additional Math: Increment - Decrement

## Description

The Decrement Stored Integer block decreases the stored integer value of a signal by one.

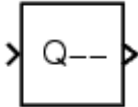

Floating-point signals are also decreased by one, and overflows always wrap.

## Data Type Support

The Decrement Stored Integer block accepts signals of any data type supported by Simulink, including fixed-point data types.

## Parameters and Dialog Box

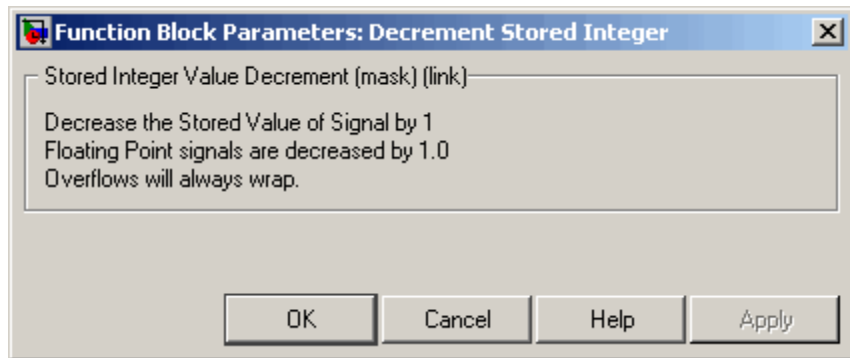

## Characteristics

Direct Feedthrough	Yes
Scalar Expansion	No

## See Also

Decrement Real World, Decrement Time To Zero, Decrement To Zero, Increment Stored Integer

# Decrement Time To Zero

## Purpose

Decrease real-world value of signal by sample time, but only to zero

## Library

Additional Math & Discrete / Additional Math: Increment - Decrement

## Description

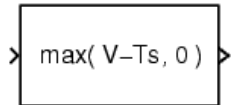

The Decrement Time To Zero block decreases the real-world value of the signal by the sample time,  $T_s$ . The output will never go below zero. This block only works with fixed sample rates.

## Data Type Support

The Decrement Time To Zero block accepts signals of any data type supported by Simulink, including fixed-point data types.

## Parameters and Dialog Box

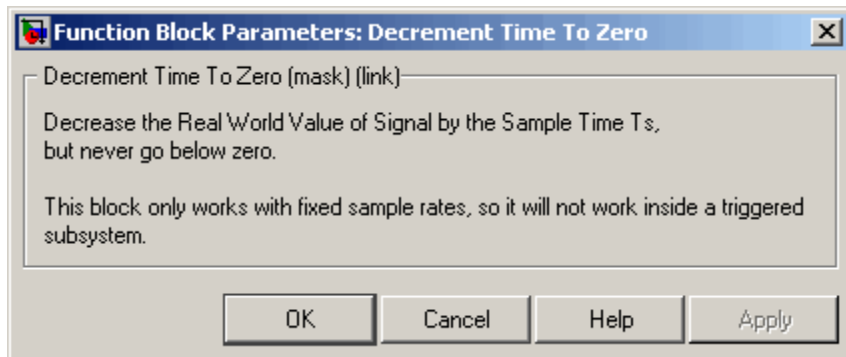

## Characteristics

Direct Feedthrough	Yes
Scalar Expansion	No

## See Also

Decrement Real World, Decrement Stored Integer, Decrement To Zero



**Purpose** Decrease real-world value of signal by one, but only to zero

**Library** Additional Math & Discrete / Additional Math: Increment - Decrement

**Description** The Decrement To Zero block decreases the real-world value of the signal by one. The output will never go below zero.

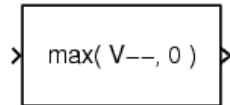

**Data Type Support** The Decrement To Zero block accepts signals of any data type supported by Simulink, including fixed-point data types.

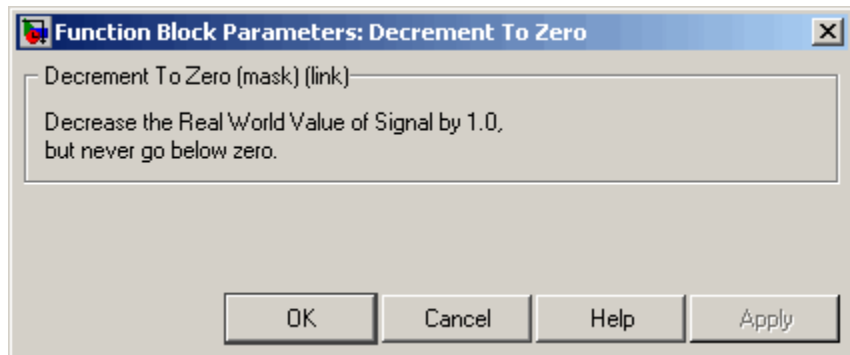

## Parameters and Dialog Box

<b>Characteristics</b>	Direct Feedthrough	Yes
	Scalar Expansion	No

**See Also** Decrement Real World, Decrement Stored Integer, Decrement Time To Zero

# Demux

---

**Purpose** Extract and output elements of bus or vector signal

**Library** Signal Routing

## Description



The Demux block extracts the components of an input signal and outputs the components as separate signals. The output signals are ordered from top to bottom output port. (See “Changing the Orientation of a Block” in Using Simulink for a description of the port order for various block orientations.) To avoid adding clutter to a model, Simulink hides the name of a Demux block when you copy it from the Simulink library to a model.

The **Number of outputs** parameter allows you to specify the number and, optionally, the dimensionality of each output port. If you do not specify the dimensionality of the outputs, the block determines the dimensionality of the outputs for you.

The Demux block operates in either vector mode or bus selection mode, depending on whether you selected the **Bus selection mode** parameter. The two modes differ in the types of signals they accept. Vector mode accepts only a vector-like signal, that is, either a scalar (one-element array), vector (1-D array), or a column or row vector (one row or one column 2-D array). Bus selection mode accepts only the output of a Mux block or another Demux block.

---

**Note** The MathWorks discourages enabling **Bus selection mode** and using a Demux block to extract elements of a bus signal. Muxes and buses should not be intermixed in new models. See “Intermixing Composite Signal Types” for details.

---

The Demux block’s **Number of outputs** parameter determines the number and dimensionality of the block’s outputs, depending on the mode in which the block operates.

### Specifying the Number of Outputs in Vector Mode

In vector mode, the value of the parameter can be a scalar specifying the number of outputs or a vector whose elements specify the widths of the block's output ports. The block determines the size of its outputs from the size of the input signal and the value of the **Number of outputs** parameter.

The following table summarizes how the block determines the outputs for an input vector of width  $n$ .

Parameter Value	Block outputs...	Comments
$p = n$	$p$ scalar signals	For example, if the input is a three-element vector and you specify three outputs, the block outputs three scalar signals.
$p > n$	Error	
$p < n$ $n \bmod p = 0$	$p$ vector signals each having $n/p$ elements	If the input is a six-element vector and you specify three outputs, the block outputs three two-element vectors.
$p < n$ $n \bmod p = m$	$m$ vector signals each having $(n/p)+1$ elements and $p-m$ signals having $n/p$ elements	If the input is a five-element vector and you specify three outputs, the block outputs two two-element vector signals and one scalar signal.
$[p_1 \ p_2 \ \dots \ p_m]$ $p_1+p_2+\dots+p_m=n$ $p_i > 0$	$m$ vector signals having widths $p_1, p_2, \dots, p_m$	If the input is a five-element vector and you specify $[3, 2]$ as the output, the block outputs three of the input elements on one port and the other two elements on the other port.

# Demux

Parameter Value	Block outputs...	Comments
$[p_1 \ p_2 \ \dots \ p_m]$ $p_1 + p_2 + \dots + p_m = n$ some or all $p_i = -1$	m vector signals	If $p_i$ is greater than zero, the corresponding output has width $p_i$ . If $p_i$ is -1, the width of the corresponding output is dynamically sized.
$[p_1 \ p_2 \ \dots \ p_m]$ $p_1 + p_2 + \dots + p_m \neq n$ $p_i = > 0$	Error	

Note that you can specify the number of outputs as fewer than the number of input elements, in which case the block distributes the elements as evenly as possible over the outputs as illustrated in the following example.

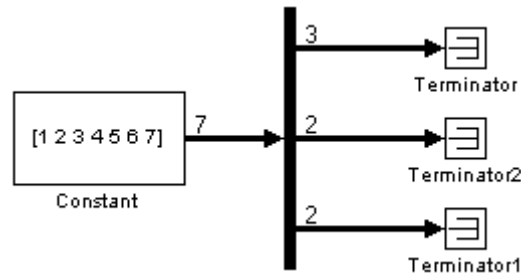

You can use -1 in a vector expression to indicate that the block should dynamically size the corresponding port. For example, the expression  $[-1, \ 3 \ -1]$  causes the block to output three signals in which the second signal always has three elements while the sizes of the first and third signals depend on the size of the input signal.

If a vector expression comprises positive values and -1 values, the block assigns as many elements as needed to the ports with positive values and distributes the remain elements as evenly as possible over the ports with -1 values. For example, suppose that the block input is seven

elements wide and you specify the output as  $[-1, 3 -1]$ . In this case, the block outputs two elements on the first port, three elements on the second, and two elements on the third.

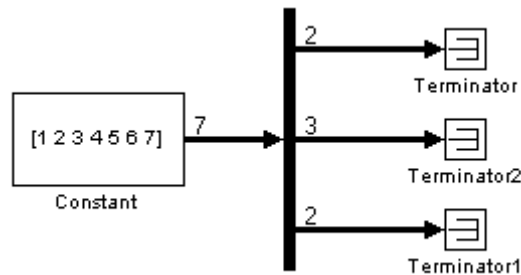

### Specifying the Number of Outputs in Bus Selection Mode

In bus selection mode, the value of the **Number of outputs** parameter can be a

- Scalar specifying the number of output ports

The specified value must equal the number of input signals. For example, if the input bus comprises two signals and the value of this parameter is a scalar, the value must equal 2.

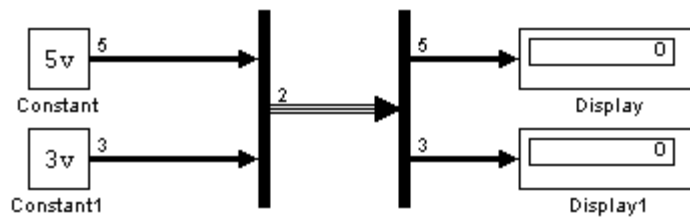

- Vector each of whose elements specifies the number of signals to output on the corresponding port

# Demux

For example, if the input bus contains five signals, you can specify the output as [3, 2], in which case the block outputs three of the input signals on one port and the other two signals on a second port.

- Cell array each of whose elements is a cell array of vectors specifying the dimensions of the signals output by the corresponding port

The cell array format constrains the Demux block to accept only signals of specified dimensions. For example, the cell array `{{[2 2], 3} {1}}` tells the block to accept only a bus signal comprising a 2-by-2 matrix, a three-element vector, and a scalar signal. You can use the value -1 in a cell array expression to let the block determine the dimensionality of a particular output based on the input. For example, the following diagram uses the cell array expression `{{-1}, {-1,-1}}` to specify the output of the leftmost Demux block.

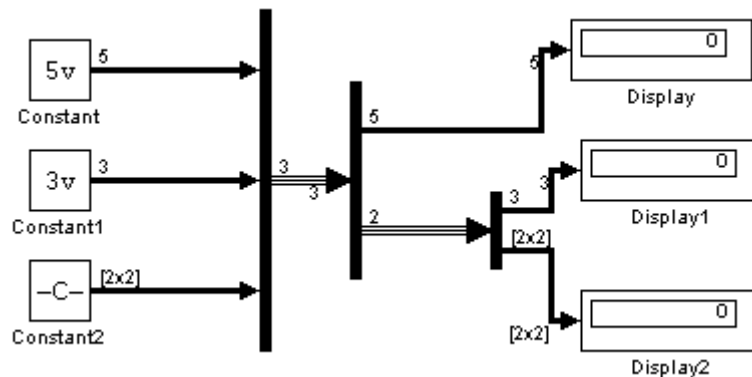

In bus selection mode, if you specify the dimensionality of an output port, i.e., if you specify any value other than -1, the corresponding input element must match the specified dimensionality.

---

**Note** The MathWorks discourages enabling **Bus selection mode** and using a Demux block to extract elements of a bus signal. Muxes and buses should not be intermixed in new models. See “Intermixing Composite Signal Types” for details.

---

## Data Type Support

The Demux block accepts and outputs complex or real signals of any data type supported by Simulink, including fixed-point data types.

For a discussion on the data types supported by Simulink, see “Data Types Supported by Simulink” in the “Working with Data” chapter of the Using Simulink documentation.

## Parameters and Dialog Box

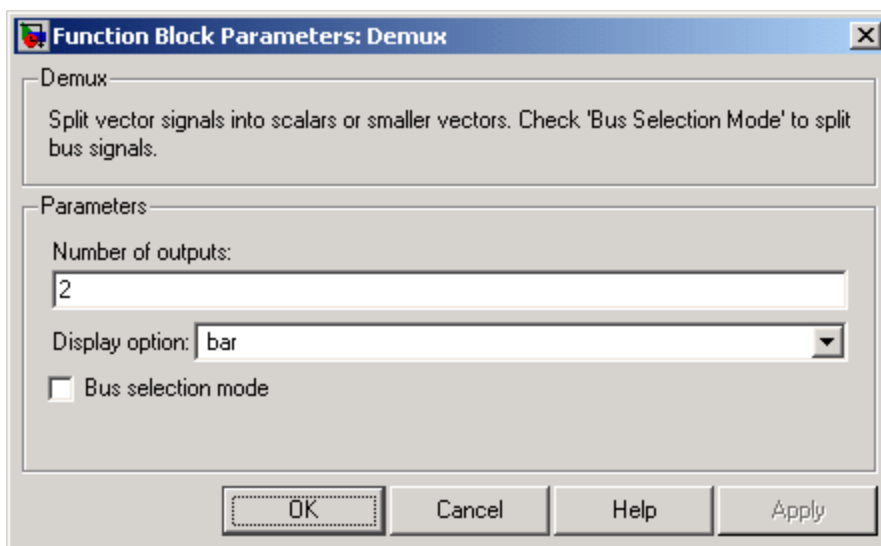

### Number of outputs



The number and dimensions of outputs.

### Display option

Options for displaying the Demux block. The options are

# Demux

---

Option	Description	Example
bar	Display the icon as a solid bar of the block's foreground color.	
none	Display the icon as a box containing the block's type name.	

## Bus selection mode

Enable bus selection mode.

---

**Note** The MathWorks discourages enabling **Bus selection mode** and using a Demux block to extract elements of a bus signal. Muxes and buses should not be intermixed in new models. See “Intermixing Composite Signal Types” for details.

---



**Purpose** Output time derivative of input

**Library** Continuous

**Description** The Derivative block approximates the derivative of its input by computing



$$\frac{du}{dt}$$

where  $du$  is the change in input value and  $dt$  is the change in time since the previous simulation time step. The block accepts one input and generates one output. The initial output for the block is zero.

The accuracy of the results depends on the size of the time steps taken in the simulation. Smaller steps allow a smoother and more accurate output curve from this block. Unlike blocks that have continuous states, the solver does not take smaller steps when the input changes rapidly.

When the input is a discrete signal, the continuous derivative of the input is an impulse when the value of the input changes, otherwise it is 0. You can obtain the discrete derivative of a discrete signal using

$$y(k) = \frac{1}{\Delta t}(u(k) - u(k-1))$$

and taking the  $z$ -transform

$$\frac{Y(z)}{u(z)} = \frac{1-z^{-1}}{\Delta t} = \frac{z-1}{\Delta t \cdot z}$$

See “Circuit Model” in *Using Simulink* for an example on choosing the best-form mathematical model to avoid using Derivative blocks in your models.

Using `linmod` to linearize a model that contains a Derivative block can be troublesome. To improve the accuracy of linearizations of this block, use the optional linearization parameter within the block dialog box. Additionally, for more information about how to avoid problems

# Derivative

linearizing Derivative blocks, see Linearizing Models in the “Analyzing Simulation Results” chapter of the Using Simulink documentation.

## Data Type Support

The Derivative block accepts and outputs a real signal of type double.

## Parameters and Dialog Box

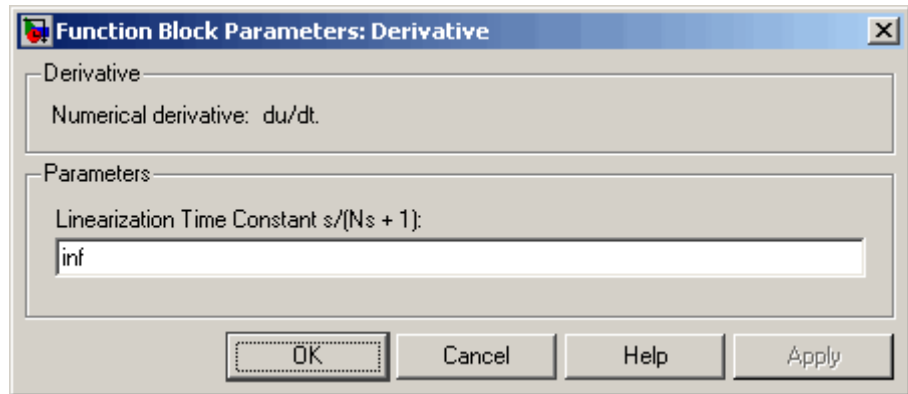

The exact linearization of the Derivative block is difficult due to the fact that the block cannot be represented as a state space system since the dynamic equation for the block is  $y = \dot{u}$ . However, it is possible to approximate the linearization by adding a pole to the Derivative to create a proper transfer function. The addition of the pole has the effect of filtering the signal before differentiating it, to remove the effect of noise. The approximated linearization of the Derivative block is then

$\frac{s}{Ns+1}$ . You can change the **Linearization Time Constant**,  $N$ , to more accurately approximate the linearization for your system. Its default value is Inf, corresponding to a linearization of 0, but it is common

practice to change it to  $\frac{1}{f_b}$ , where  $f_b$  is the break frequency for the filter.

<b>Characteristics</b>	Direct Feedthrough	Yes
	Sample Time	Continuous
	Scalar Expansion	N/A
	States	$2 * [1 + (\text{number of input elements})]$
	Dimensionalized	Yes
	Zero Crossing	No

**See Also** Discrete Derivative

# Detect Change

**Purpose** Detect change in signal's value

**Library** Logic and Bit Operations

**Description** The Detect Change block determines if an input does not equal its previous value where

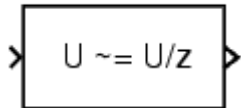

- The output is true (equal to 1), when the input signal does not equal its previous value.
- The output is false (equal to 0), when the input signal equals its previous value.

**Data Type Support** The Detect Change block accepts signals of any data type supported by Simulink, including fixed-point data types. The block output is uint8.

## Parameters and Dialog Box

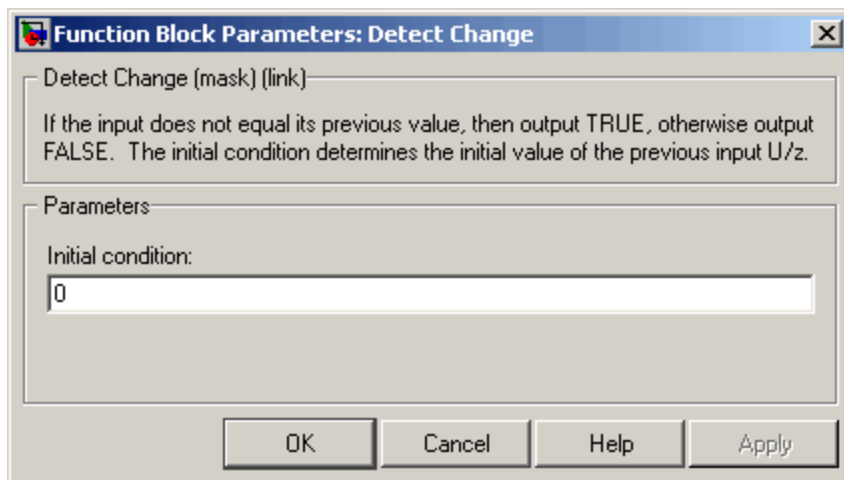

### Initial condition

Set the initial condition for the previous input U/z.

<b>Characteristics</b>	Direct Feedthrough	Yes
	Scalar Expansion	Yes

**See Also** Detect Decrease, Detect Fall Negative, Detect Fall Nonpositive, Detect Increase, Detect Rise Nonnegative, Detect Rise Positive

# Detect Decrease

**Purpose** Detect decrease in signal's value

**Library** Logic and Bit Operations

**Description** The Detect Decrease block determines if an input is strictly less than its previous value where

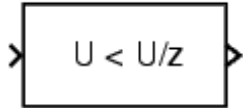

- The output is true (equal to 1), when the input signal is less than its previous value.
- The output is false (equal to 0), when the input signal is greater than or equal to its previous value.

**Data Type Support** The Detect Decrease block accepts signals of any data type supported by Simulink, including fixed-point data types. The block output is uint8.

## Parameters and Dialog Box

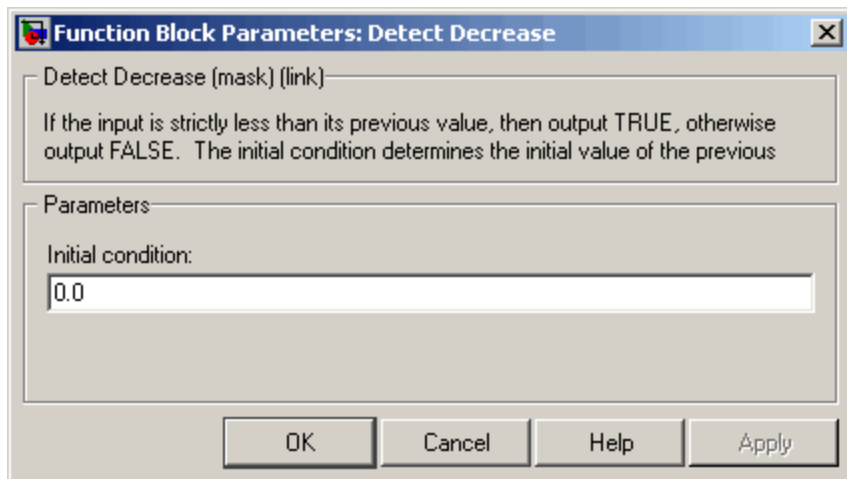

### Initial condition

Set the initial condition for the previous input U/z.

<b>Characteristics</b>	Direct Feedthrough	Yes
	Scalar Expansion	Yes

**See Also** Detect Change, Detect Fall Negative, Detect Fall Nonpositive, Detect Increase, Detect Rise Nonnegative, Detect Rise Positive

# Detect Fall Negative

---

**Purpose** Detect falling edge when signal's value decreases to strictly negative value, and its previous value was nonnegative

**Library** Logic and Bit Operations

**Description** The Detect Fall Negative block determines if the input is less than zero, and its previous value was greater than or equal to zero where

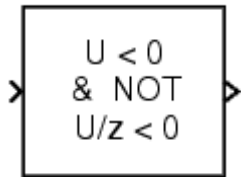

- The output is true (equal to 1), when the input signal is less than zero, and its previous value was greater than or equal to zero.
- The output is false (equal to 0), when the input signal is greater than or equal to zero, or if the input signal is nonnegative, its previous value was positive or zero.

**Data Type Support** The Detect Fall Negative block accepts signals of any data type supported by Simulink, including fixed-point data types. The block output is uint8.

**Parameters and Dialog Box** **Initial condition**  
Set the initial condition of the Boolean expression  $U/z < 0$ .

<b>Characteristics</b>	Direct Feedthrough	Yes
	Scalar Expansion	Yes

**See Also** Detect Change, Detect Decrease, Detect Fall Nonpositive, Detect Increase, Detect Rise Nonnegative, Detect Rise Positive



- Purpose** Detect falling edge when signal's value decreases to nonpositive value, and its previous value was strictly positive
- Library** Logic and Bit Operations
- Description** The Detect Fall Nonpositive block determines if the input is less than or equal to zero, and its previous value was positive where
- The output is true (equal to 1), when the input signal is less than or equal to zero, and its previous value was greater than zero.
  - The output is false (equal to 0), when the input signal is greater than zero, or if it is nonpositive, its previous value was nonpositive.
- Data Type Support** The Detect Fall Nonpositive block accepts signals of any data type supported by Simulink, including fixed-point data types. The block output is uint8.

## Parameters and Dialog Box

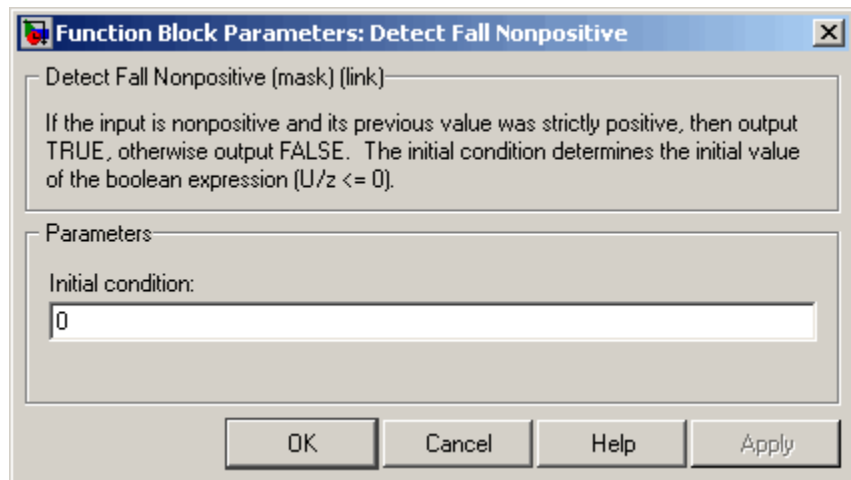

### Initial condition

Set the initial condition of the Boolean expression  $U/z \leq 0$ .

# Detect Fall Nonpositive

---

<b>Characteristics</b>	Direct Feedthrough	Yes
	Scalar Expansion	Yes

**See Also** Detect Change, Detect Decrease, Detect Fall Negative, Detect Increase, Detect Rise Nonnegative, Detect Rise Positive

**Purpose** Detect increase in signal's value

**Library** Logic and Bit Operations

**Description** The Detect Increase block determines if an input is strictly greater than its previous value where

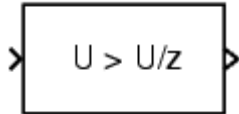

- The output is true (equal to 1), when the input signal is greater than its previous value.
- The output is false (equal to 0), when the input signal is less than or equal to its previous value.

**Data Type Support** The Detect Increase block accepts signals of any data type supported by Simulink, including fixed-point data types. The block output is uint8.

## Parameters and Dialog Box

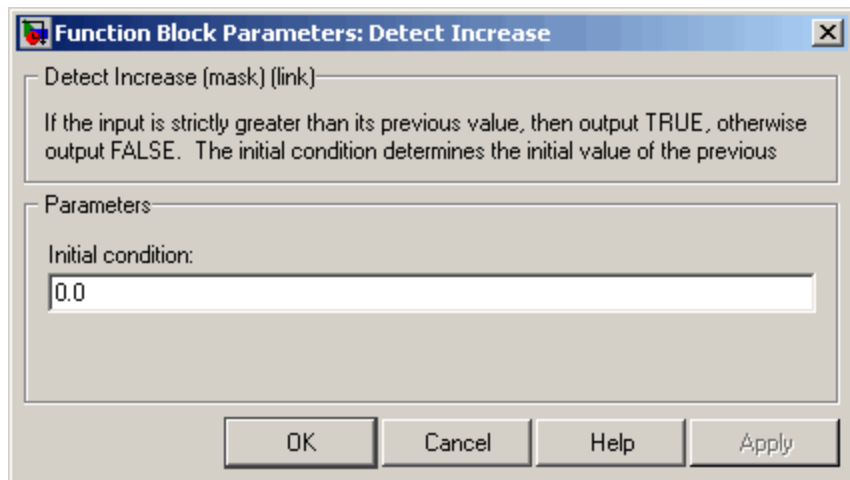

### Initial condition

Set the initial condition for the previous input U/z.

# Detect Increase

---

<b>Characteristics</b>	Direct Feedthrough	Yes
	Scalar Expansion	Yes

**See Also** Detect Change, Detect Decrease, Detect Fall Negative, Detect Fall Nonpositive, Detect Rise Nonnegative, Detect Rise Positive

## Purpose

Detect rising edge when signal's value increases to nonnegative value, and its previous value was strictly negative

## Library

Logic and Bit Operations

## Description

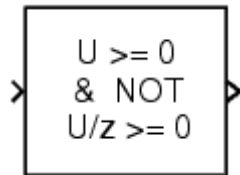

The Detect Rise Nonnegative block determines if the input is greater than or equal to zero, and its previous value was less than zero where

- The output is true (equal to 1), when the input signal is greater than or equal to zero, and its previous value was less than zero.
- The output is false (equal to 0), when the input signal is less than zero, or if nonnegative, its previous value was greater than or equal to zero.

## Data Type Support

The Detect Rise Nonnegative block accepts signals of any data type supported by Simulink, including fixed-point data types. The block output is uint8.

## Parameters and Dialog Box

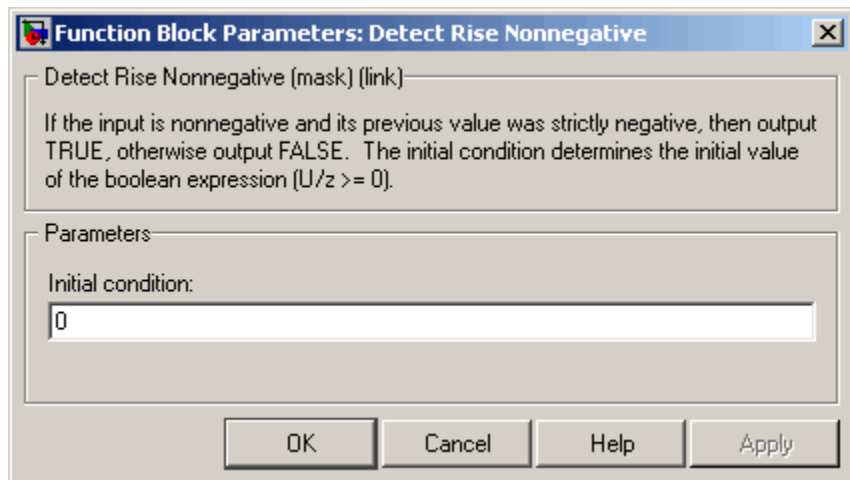

# Detect Rise Nonnegative

---

## Initial condition

Set the initial condition of the Boolean expression  $U/z \geq 0$ .

## Characteristics

Direct Feedthrough	Yes
Scalar Expansion	Yes

## See Also

Detect Change, Detect Decrease, Detect Fall Negative, Detect Fall Nonpositive, Detect Increase, Detect Rise Positive

## Purpose

Detect rising edge when signal's value increases to strictly positive value, and its previous value was nonpositive

## Library

Logic and Bit Operations

## Description

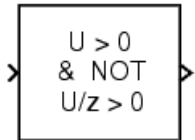

The Detect Rise Positive block determines if the input is strictly positive, and its previous value was nonpositive where

- The output is true (equal to 1), when the input signal is greater than zero, and its previous value was less than zero.
- The output is false (equal to 0), when the input is negative or zero, or if the input is positive, its previous value was also positive.

## Data Type Support

The Detect Rise Positive block accepts signals of any data type supported by Simulink, including fixed-point data types. The block output is uint8.

## Parameters and Dialog Box

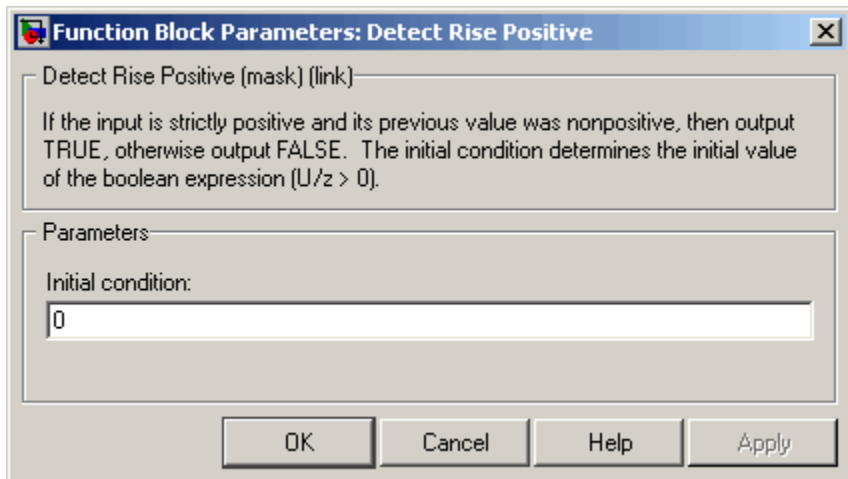

### Initial condition

Set the initial condition of the Boolean expression  $U/z > 0$ .

# Detect Rise Positive

---

<b>Characteristics</b>	Direct Feedthrough	Yes
	Scalar Expansion	Yes

**See Also** Detect Change, Detect Decrease, Detect Fall Negative, Detect Fall Nonpositive, Detect Increase, Detect Rise Nonnegative



**Purpose** Calculate change in signal over one time step

**Library** Discrete

**Description** The Difference block outputs the current input value minus the previous input value.

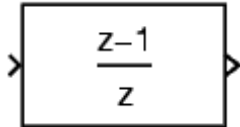

**Data Type Support** The Difference block accepts signals of any data type supported by Simulink, including fixed-point data types.

**Parameters and Dialog Box** The **Main** pane of the Difference block dialog appears as follows:

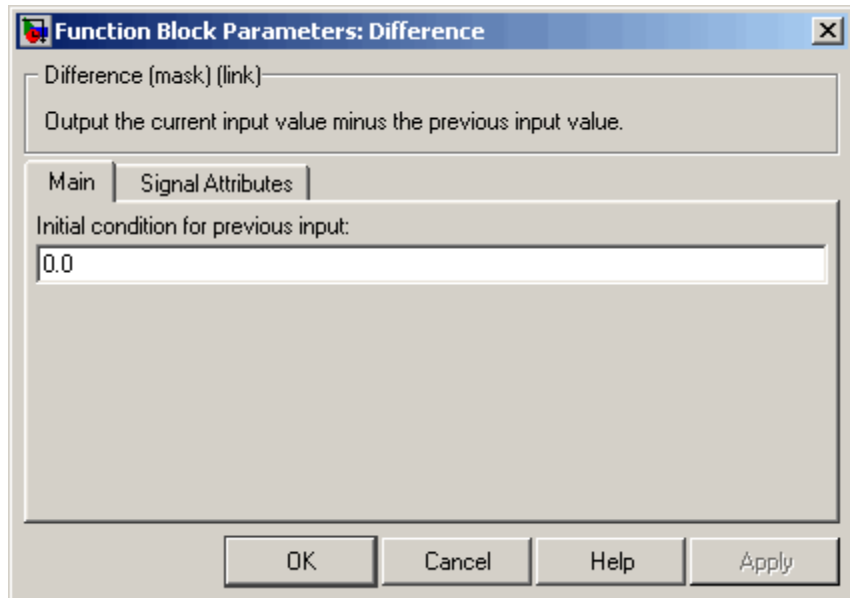

# Difference

## Initial condition for previous output

Set the initial condition for the previous output.

The **Signal Attributes** pane of the Difference block dialog appears as follows:

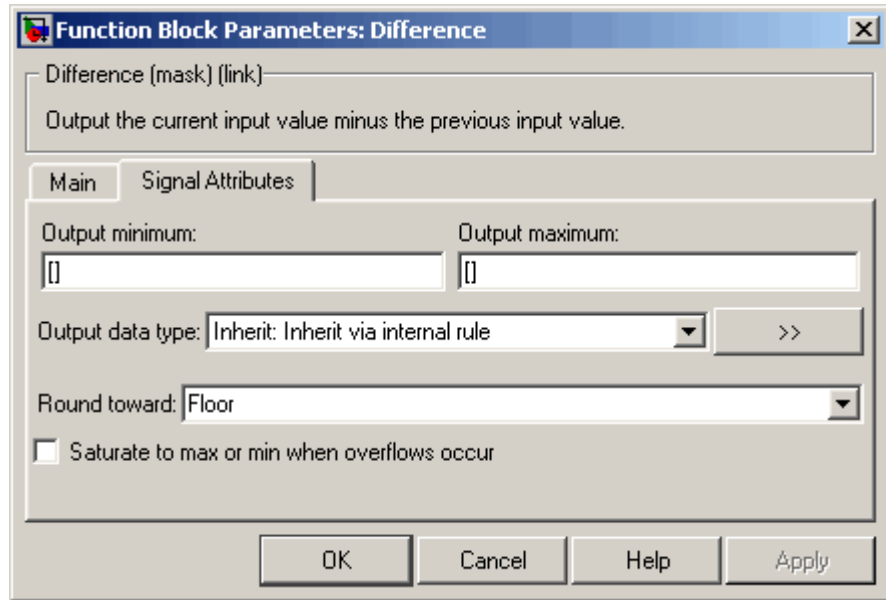

## Output minimum

Specify the minimum value that the block should output. The default value, [ ], is equivalent to  $-\text{Inf}$ . Simulink uses this value to perform:

- Simulation range checking (see “Checking Signal Ranges”)
- Automatic scaling of fixed-point data types

## Output maximum

Specify the maximum value that the block should output. The default value, [ ], is equivalent to  $\text{Inf}$ . Simulink uses this value to perform:

- Simulation range checking (see “Checking Signal Ranges”)
- Automatic scaling of fixed-point data types

## Output data type

Specify the output data type. You can set it to:

- A rule that inherits a data type, for example, `Inherit: Inherit via back propagation`
- The name of a built-in data type, for example, `single`
- The name of a data type object, for example, a `Simulink.NumericType` object
- An expression that evaluates to a data type, for example, `float('single')`

Click the **Show data type assistant** button  to display the **Data Type Assistant**, which helps you set the **Output data type** parameter.

See “Specifying Block Output Data Types” in *Using Simulink* for more information.

## Lock output scaling against changes by the autoscaling tool

Select to lock scaling of outputs. This parameter is visible only if you enter an expression for the **Output data type** parameter.

## Round toward

Rounding mode for the fixed-point output.

## Saturate to max or min when overflows occur

If selected, fixed-point overflows saturate.

## Characteristics

Direct Feedthrough	Yes
Scalar Expansion	Yes, of inputs and gain

# Digital Clock

---

**Purpose** Output simulation time at specified sampling interval

**Library** Sources

**Description** The Digital Clock block outputs the simulation time only at the specified sampling interval. At other times, the output is held at the previous value.



Use this block rather than the Clock block (which outputs continuous time) when you need the current time within a discrete system.

**Data Type Support** The Digital Clock block outputs a real signal of type double.

## Parameters and Dialog Box

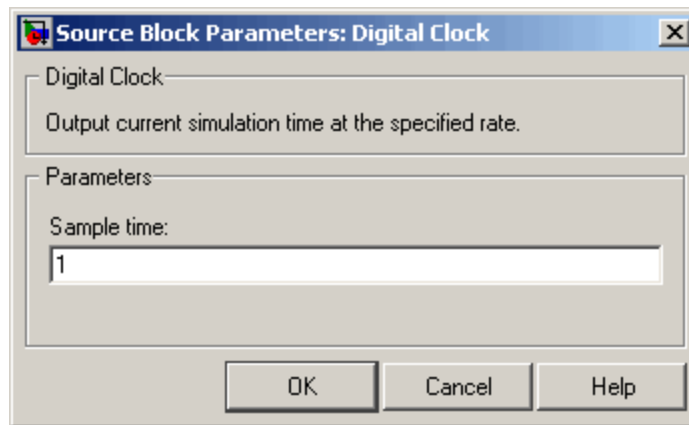

**Sample time** The sampling interval. The default value is 1 second. See Specifying Sample Time in the “How Simulink Works” chapter of the Using Simulink documentation.

<b>Characteristics</b>	Sample Time	Specified in the <b>Sample time</b> parameter
	Scalar Expansion	No
	Dimensionalized	No
	Zero Crossing	No

# Direct Lookup Table (n-D)

## Purpose

Index into N-dimensional table to retrieve element, column, or 2-D matrix

## Library

Lookup Tables

## Description

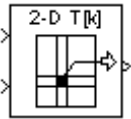

The Direct Lookup Table (n-D) block uses its block inputs as zero-based indices into an n-D table. The number of inputs varies with the shape of the output desired. The output can be an element, a column, or a 2-D matrix. The lookup table uses zero-based indexing, so integer data types can fully address their range. For example, a table dimension using the uint8 data type can address all 256 elements.

You define a set of output values as the **Table data** parameter. You specify what object the inputs select from the table: an element, a column, or a 2-D matrix. The first input specifies the zero-based index to the first dimension higher than the number of dimensions in the output, the next input specifies the index to the next table dimension, and so on, as shown by this figure:

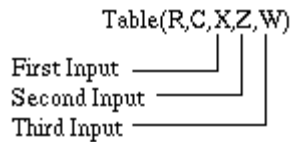

The figure shows a 5-D table with an output shape set to “2-D Matrix”; the output is a 2-D Matrix with R rows and C columns. (See “Changing the Orientation of a Block” in Using Simulink for a description of the port order for various block orientations.)

This figure shows the set of all the different icons that the Direct Lookup Table block shows (depending on the options you choose in the block’s dialog box).

# Direct Lookup Table (n-D)

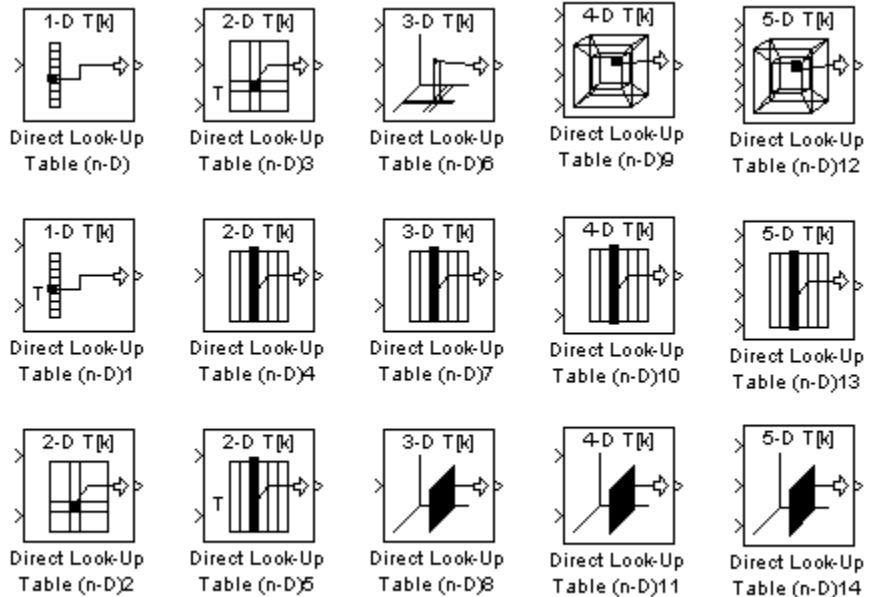

With dimensions higher than 4, the icon matches the 4-D icons, but shows the exact number of dimensions in the top text, e.g., “8-D T[k].” The top row of icons is used when the block output is made from one or more single-element lookups on the table. The blocks labeled “n-D Direct Table Lookup5,” 6, 8, and 12 are configured to extract a column from the table, and the two blocks ending in 7 and 9 are extracting a plane from the table. Blocks in the figure ending in 10, 11, and 12 are configured to have the table be an input instead of a parameter.

## Example

In this example, the block parameters are defined as

```
Inputs select this object from table: "Column"  
Table data: int16(a)
```

# Direct Lookup Table (n-D)

where `a` is a 4-D array of linearly increasing numbers calculated using MATLAB.

```
a = ones(20,4,5,7); L = prod(size(a));  
a(1:L) = [1:L]';
```

The figure shows the block outputting a vector of the 20 values in the second column of the fourth element of the third dimension from the third element of the fourth dimension.

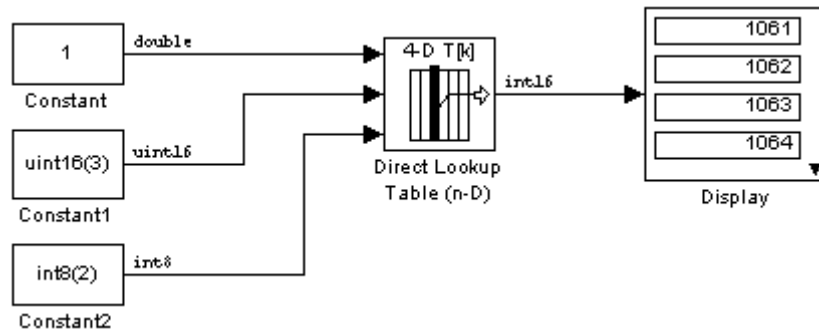

Note that the output has the same data type as the table, i.e., `int16`. Also note that the block uses zero-based indexing. The output values in this example can be calculated manually in MATLAB (which uses 1-based indexing):

```
a(:,1+1,1+3,1+2)
```

```
ans =
```

```
1061  
1062  
1063  
1064  
1065  
1066  
1067  
1068
```



1069  
1070  
1071  
1072  
1073  
1074  
1075  
1076  
1077  
1078  
1079  
1080

### Data Type Support

The Direct Lookup Table (n-D) block accepts mixed-type signals of data type supported by Simulink. For a discussion on the data types supported by Simulink, see “Data Types Supported by Simulink” in the “Working with Data” chapter of the Using Simulink documentation.

The output type can differ from the input type and can be any of the types listed for input; the output type is inherited from the data type of the **Table data** parameter.

In the case that the table comes into the block on an input port, the output port type is inherited from the table input port. Inputs for indexing must be real; table data can be complex.

# Direct Lookup Table (n-D)

## Parameters and Dialog Box

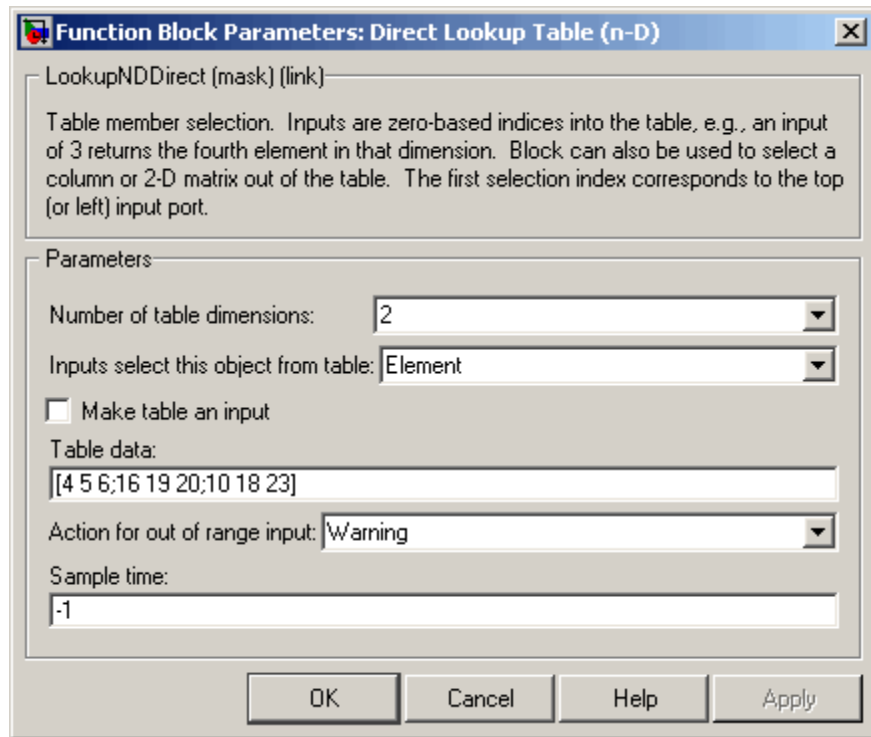

### Number of table dimensions

The number of dimensions that the **Table data** parameter must have. This determines the number of independent variables for the table and hence the number of inputs to the block. The options are 1, 2, 3, 4, or More dimensions. If you choose More, the dialog box displays an edit field, **Explicit number of table dimensions**, that allows you to enter a number of dimensions.

### Explicit number of table dimensions

This field appears if you select more as the value of the **Number of table dimensions**. Enter the number of table dimensions in this field.

## Inputs select this object from table

Specify whether the output data is a single element, a column, or a 2-D matrix. The number of ports changes for each selection:

Element — # of ports = # of dimensions

Column — # of ports = # of dimensions - 1

2-D matrix — # of ports = # of dimensions - 2

This numbering agrees with MATLAB indexing. For example, if you have a 4-D table of data, to access a single element you must specify four indices, as in `array(1,2,3,4)`. To specify a column, you need three indices, as in `array(:,2,3,4)`. Finally, to specify a 2-D matrix, you only need two indices, as in `array(:, :, 3,4)`.

## Make table an input

Selecting this box forces the Direct Lookup Table (n-D) block to ignore the Table Data parameter. Instead, a new port appears with “T” next to it. Use this port to input table data.

## Table data

The table of output values. The matrix size must match the dimensions defined by the **Number of table dimensions** parameter or by the **Explicit number of dimensions** parameter when the number of dimensions exceeds four. During block diagram editing, you can leave the **Table data** field empty, but for running the simulation, you must match the number of dimensions in the **Table data** to the **Number of table dimensions**. For information about how to construct multidimensional arrays in MATLAB, see “Multidimensional Arrays” in the MATLAB online documentation. (This field appears only if **Make table an input** is not selected.)

## Action for out of range input

None, Warning, Error.

# Direct Lookup Table (n-D)

---

## Sample time

The time interval between samples. To inherit the sample time, set this parameter to -1. See “Specifying Sample Time” in the Using Simulink documentation for more information.

## Characteristics

Direct Feedthrough	Yes
Sample Time	Specified in the <b>Sample time</b> parameter
Scalar Expansion	For scalar lookups only (not when returning a column or a 2-D matrix from the table)
Dimensionalized	For scalar lookups only (not when returning a column or a 2-D matrix from the table)
Zero Crossing	No

**Purpose** Compute discrete time derivative

**Library** Discrete

**Description** The Discrete Derivative block computes an optionally scaled discrete time derivative as follows

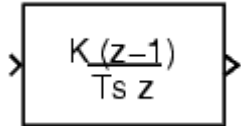

$$y(t_n) = \frac{Ku(t_n)}{T_s} - \frac{Ku(t_{n-1})}{T_s}$$

where  $y(t_n)$  and  $u(t_n)$  are the block's input and output at the current time step, respectively,  $u(t_{n-1})$  is the block's input at the previous time step,  $K$  is a scaling factor, and  $T_s$  is the simulation's discrete step size, which must be fixed.

**Data Type Support** The Discrete Derivative block supports all Simulink data types, including fixed-point data types.

For a discussion on the data types supported by Simulink, see “Data Types Supported by Simulink” in the “Working with Data” chapter of the Using Simulink documentation.

# Discrete Derivative

## Parameters and Dialog Box

The **Main** pane of the Discrete Derivative block dialog appears as follows:

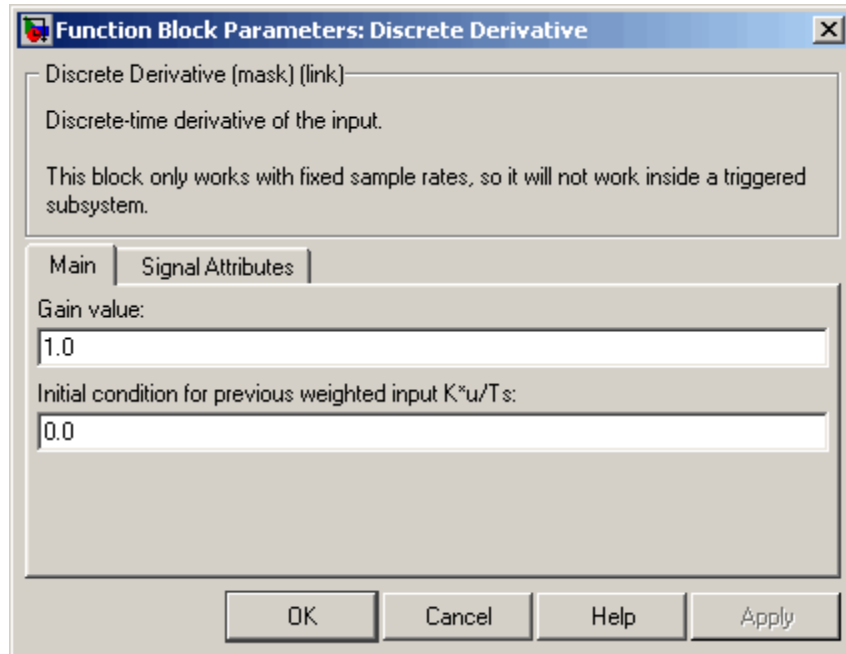

### Gain value

Scaling factor used to weight the block's input at the current time step.

### Initial condition for previous weighted input $K \cdot u / T_s$

Set the initial condition for the previous scaled input.

The **Signal Attributes** pane of the Discrete Derivative block dialog box appears as follows:

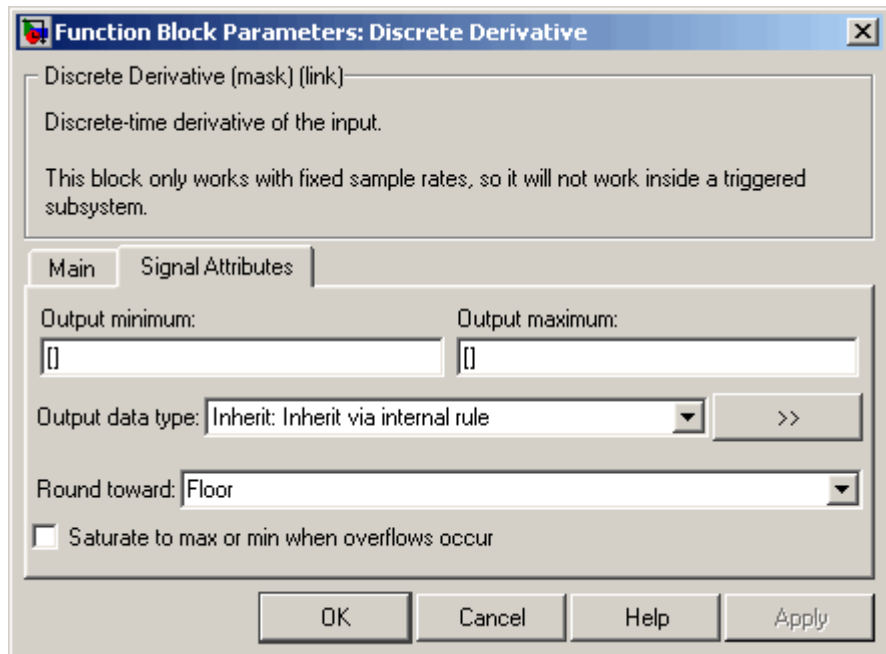

## Output minimum

Specify the minimum value that the block should output. The default value, [], is equivalent to  $-\infty$ . Simulink uses this value to perform:

- Simulation range checking (see “Checking Signal Ranges”)
- Automatic scaling of fixed-point data types

## Output maximum

Specify the maximum value that the block should output. The default value, [], is equivalent to  $\infty$ . Simulink uses this value to perform:

- Simulation range checking (see “Checking Signal Ranges”)
- Automatic scaling of fixed-point data types

# Discrete Derivative

---

## Output data type

Specify the output data type. You can set it to:

- A rule that inherits a data type, for example, `Inherit: Inherit` via back propagation
- The name of a built-in data type, for example, `single`
- The name of a data type object, for example, a `Simulink.NumericType` object
- An expression that evaluates to a data type, for example, `float('single')`

Click the **Show data type assistant** button  to display the **Data Type Assistant**, which helps you set the **Output data type** parameter.

See “Specifying Block Output Data Types” in *Using Simulink* for more information.

## Lock output scaling against changes by the autoscaling tool

Select to lock scaling of outputs. This parameter is visible only if you enter an expression for the **Output data type** parameter.

## Round toward

Select the rounding mode for fixed-point operations.

## Saturate to max or min when overflows occur

If selected, fixed-point overflows saturate.

## Characteristics

Direct Feedthrough	Yes
Scalar Expansion	Yes, of inputs and gain

## See Also

Derivative



**Purpose** Model IIR and FIR filters

**Library** Discrete

## Description

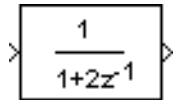

The Discrete Filter block models Infinite Impulse Response (IIR) and Finite Impulse Response (FIR) filters. You specify the filter as a ratio of polynomials in  $z^{-1}$ . You can specify that the block have a scalar output or vector output where the elements correspond to a set of filters that have the same denominator polynomial but different numerator polynomials.

Use the **Numerator coefficient** parameter to specify the coefficients of the discrete filter's numerator polynomial or polynomials. Use a vector to specify the coefficients for a single numerator polynomial. Use a matrix to specify the coefficients of multiple numerator polynomials where each row contains the coefficients of one of the polynomials. Use the **Denominator coefficient** parameter to specify the coefficients of the function's denominator polynomial. The value of the **Denominator coefficient** parameter must be a vector of coefficients.

You must specify the coefficients of the numerator and denominator polynomials in ascending powers of  $z^{-1}$ . The order of the denominator must be greater than or equal to the order of the numerator.

If you specify a single numerator polynomial, i.e., a vector as the value of the **Numerator coefficient** parameter, the block's output is a scalar signal. If you specify multiple numerator polynomials, i.e., a matrix as the value of the **Numerator coefficients** parameter, the block's output is a vector signal whose width equals the number of matrix rows, i.e., the number of numerator polynomials.

The Discrete Filter block lets you use polynomials in  $z^{-1}$  (the delay operator) to represent a discrete system, a method typically used by signal processing engineers. By contrast, the Discrete Transfer Fcn block lets you use polynomials in  $z$  to represent a discrete system, the method typically used by control engineers. The two methods are identical when the numerator and denominator polynomials have the same length.

# Discrete Filter

The block displays the numerator and denominator according to how they are specified. For a discussion of how Simulink displays the icon, see Transfer Fcn.

## Data Type Support

The Discrete Filter block accepts and outputs a real signal of type single or double.

## Parameters and Dialog Box

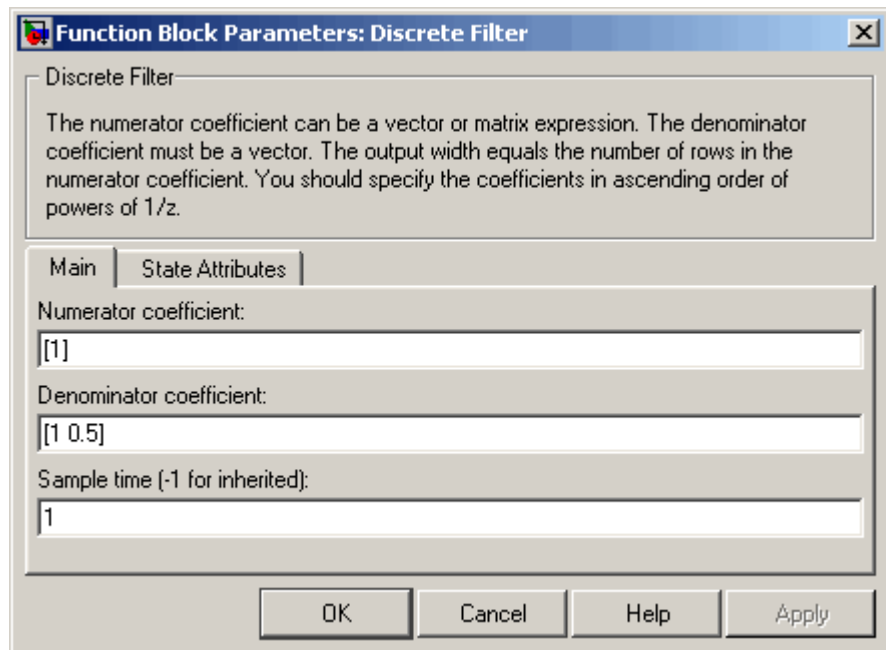

### Numerator coefficient

A vector of polynomial coefficients or a matrix of coefficients where each row of coefficients corresponds to a distinct numerator polynomial. You must specify the polynomial coefficients in ascending powers of  $z^{-1}$ . If you specify a vector of coefficients, i.e., a single numerator polynomial, the output of the block is a scalar signal. If you specify a matrix of coefficients, i.e., multiple polynomials, the block's output is a vector of signals,

each corresponding to the filter consisting of the corresponding numerator polynomial and the denominator polynomial specified by the **Denominator coefficients** parameter. The default is [1].

### Denominator coefficient

The vector of denominator coefficients. The default is [1 0.5]. The width of the vector, i.e., the order of the denominator, must be greater than or equal to the width of the numerator vector or matrix rows, i.e., the order of the numerator.

### Sample time

The time interval between samples. See Specifying Sample Time in the “How Simulink Works” chapter of the Using Simulink documentation.

The **State Attributes** pane of this block pertains to code generation and has no effect on model simulation. See “Block State Storage and Interfacing” in the Real-Time Workshop User’s Guide for more information.

## Characteristics

Direct Feedthrough	Only if the lengths of the <b>Numerator</b> and <b>Denominator</b> parameters are equal
Sample Time	Specified in the <b>Sample time</b> parameter
Scalar Expansion	No
States	Length of <b>Denominator</b> parameter -1
Dimensionalized	No
Zero Crossing	No

# Discrete State-Space

**Purpose** Implement discrete state-space system

**Library** Discrete

**Description** The Discrete State-Space block implements the system described  
$$x(n+1) = Ax(n) + Bu(n)$$

$$\begin{matrix} y(n) = Cx(n) + Du(n) \\ x(n+1) = Ax(n) + Bu(n) \end{matrix}$$

by  $y(n) = Cx(n) + Du(n)$

where  $u$  is the input,  $x$  is the state, and  $y$  is the output. The matrix coefficients must have these characteristics, as illustrated in the following diagram:

- **A** must be an n-by-n matrix, where n is the number of states.
- **B** must be an n-by-m matrix, where m is the number of inputs.
- **C** must be an r-by-n matrix, where r is the number of outputs.
- **D** must be an r-by-m matrix.

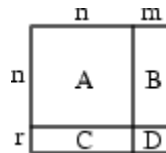

The block accepts one input and generates one output. The input vector width is determined by the number of columns in the B and D matrices. The output vector width is determined by the number of rows in the C and D matrices.

Simulink converts a matrix containing zeros to a sparse matrix for efficient multiplication.

**Data Type Support**

The Discrete State Space block accepts and outputs a real signal of type single or double.

## Parameters and Dialog Box

Function Block Parameters: Discrete State-Space

Discrete State Space

Discrete state-space model:  
 $x(n+1) = Ax(n) + Bu(n)$   
 $y(n) = Cx(n) + Du(n)$

Main | State Attributes

A:  
1

B:  
1

C:  
1

D:  
1

Initial conditions:  
0

Sample time (-1 for inherited):  
1

OK Cancel Help Apply

### **A, B, C, D**

The matrix coefficients, as defined in the preceding equations.

### **Initial conditions**

The initial state vector. The default is 0. Simulink does not allow the initial states of this block to be  $\inf$  or  $\text{NaN}$ .

# Discrete State-Space

---

## Sample time

The time interval between samples. See Specifying Sample Time in the “How Simulink Works” chapter of the Using Simulink documentation.

The **State Attributes** pane of this block pertains to code generation and has no effect on model simulation. See “Block State Storage and Interfacing” in the Real-Time Workshop User’s Guide for more information.

## Characteristics

Direct Feedthrough	Only if $D \neq 0$
Sample Time	Specified in the <b>Sample time</b> parameter
Scalar Expansion	Yes, of the initial conditions
States	Determined by the size of $A$
Dimensionalized	Yes
Zero Crossing	No

## Purpose

Perform discrete-time integration or accumulation of signal

## Library

Discrete

## Description

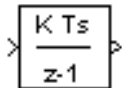

You can use the Discrete-Time Integrator block in place of the Integrator block to create a purely discrete system.

The Discrete-Time Integrator block allows you to

- Define initial conditions on the block dialog box or as input to the block.
- Define an input gain (K) value.
- Output the block state.
- Define upper and lower limits on the integral.
- Reset the state depending on an additional reset input.

These features are described below.

### Integration and Accumulation Methods

The block can integrate or accumulate using the Forward Euler, Backward Euler, and Trapezoidal methods. For a given step  $n$ , Simulink updates  $y(n)$  and  $x(n+1)$ . In integration mode,  $T$  is the block's sample time (delta  $T$  in the case of triggered sample time). In accumulation mode,  $T = 1$ ; the block's sample time determines when the block's output is computed but not the output's value.  $K$  is the gain value. Values are clipped according to upper or lower limits.

- Forward Euler method (the default), also known as Forward Rectangular, or left-hand approximation.

For this method,  $1/s$  is approximated by  $T/(z-1)$ . The resulting expression for the output of the block at step  $n$  is

$$y(n) = y(n-1) + K \cdot T \cdot u(n-1)$$

# Discrete-Time Integrator

---

Let  $x(n+1) = x(n) + K \cdot T \cdot u(n)$ . The block uses the following steps to compute its output:

$$\begin{aligned} \text{Step 0: } \quad y(0) &= x(0) = \text{IC (clip if necessary)} \\ x(1) &= y(0) + K \cdot T \cdot u(0) \end{aligned}$$

$$\begin{aligned} \text{Step 1: } \quad y(1) &= x(1) \\ x(2) &= x(1) + K \cdot T \cdot u(1) \end{aligned}$$

$$\begin{aligned} \text{Step n: } \quad y(n) &= x(n) \\ x(n+1) &= x(n) + K \cdot T \cdot u(n) \text{ (clip if necessary)} \end{aligned}$$

With this method, input port 1 does not have direct feedthrough.

- Backward Euler method, also known as Backward Rectangular or right-hand approximation.

For this method,  $1/s$  is approximated by  $T \cdot z / (z-1)$ . The resulting expression for the output of the block at step  $n$  is

$$y(n) = y(n-1) + K \cdot T \cdot u(n)$$

Let  $x(n) = y(n-1)$ . The block uses the following steps to compute its output

$$\begin{aligned} \text{Step 0: } \quad y(0) &= x(0) = \text{IC (clipped if necessary)} \\ x(1) &= y(0) \end{aligned}$$

or, depending on **Use initial condition as initial and reset value for** parameter:

$$\begin{aligned} \text{Step 0: } \quad x(0) &= \text{IC (clipped if necessary)} \\ x(1) &= y(0) = x(0) + K \cdot T \cdot u(0) \end{aligned}$$

$$\begin{aligned} \text{Step 1: } \quad y(1) &= x(1) + K \cdot T \cdot u(1) \\ x(2) &= y(1) \end{aligned}$$

$$\begin{aligned} \text{Step n: } \quad y(n) &= x(n) + K \cdot T \cdot u(n) \\ x(n+1) &= y(n) \end{aligned}$$



With this method, input port 1 has direct feedthrough.

- Trapezoidal method. For this method,  $1/s$  is approximated by

$$T/2 * (z+1) / (z-1)$$

When  $T$  is fixed (equal to the sampling period), let

$$x(n) = y(n-1) + K*T/2 * u(n-1)$$

The block uses the following steps to compute its output

$$\begin{aligned} \text{Step 0: } & x(0) = \text{IC (clipped if necessary)} \\ & x(1) = y(0) + K*T/2 * u(0) \end{aligned}$$

or, depending on **Use initial condition as initial and reset value for** parameter:

$$\begin{aligned} \text{Step 0: } & y(0) = x(0) = \text{IC (clipped if necessary)} \\ & x(1) = y(0) = x(0) + K*T/2*u(0) \end{aligned}$$

$$\begin{aligned} \text{Step 1: } & y(1) = x(1) + K*T/2 * u(1) \\ & x(2) = y(1) + K*T/2 * u(1) \end{aligned}$$

$$\begin{aligned} \text{Step n: } & y(n) = x(n) + K*T/2 * u(n) \\ & x(n+1) = y(n) + K*T/2 * u(n) \end{aligned}$$

Here,  $x(n+1)$  is the best estimate of the next output. It isn't quite the state, in the sense that  $x(n) \neq y(n)$ .

If  $T$  is variable (i.e. obtained from the triggering times), the block uses the following algorithm to compute its outputs

$$\begin{aligned} \text{Step 0: } & y(0) = x(0) = \text{IC (clipped if necessary)} \\ & x(1) = y(0) \end{aligned}$$

or, depending on **Use initial condition as initial and reset value for** parameter:

$$\text{Step 0: } y(0) = x(0) = \text{IC (clipped if necessary)}$$

# Discrete-Time Integrator

$$x(1) = y(0) = x(0) + K \cdot T / 2 \cdot u(0)$$

$$\begin{aligned} \text{Step 1: } y(1) &= x(1) + T / 2 \cdot (u(1) + u(0)) \\ x(2) &= y(1) \end{aligned}$$

$$\begin{aligned} \text{Step n: } y(n) &= x(n) + T / 2 \cdot (u(n) + u(n-1)) \\ x(n+1) &= y(n) \end{aligned}$$

With this method, input port 1 has direct feedthrough.

The block reflects the selected integration or accumulation method, as this figure shows.

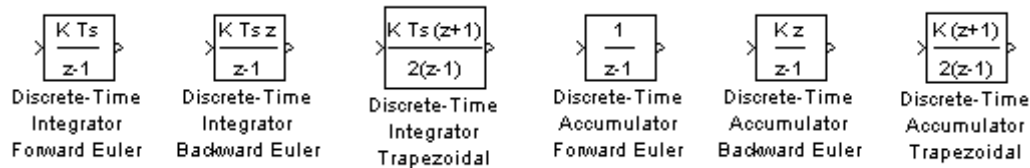

## Defining Initial Conditions

You can define the initial conditions as a parameter on the block dialog box or input them from an external signal:

- To define the initial conditions as a block parameter, specify the **Initial condition source** parameter as internal and enter the value in the **Initial condition** parameter field.
- To provide the initial conditions from an external source, specify the **Initial condition source** parameter as external. An additional input port appears under the block input, as shown in this figure.

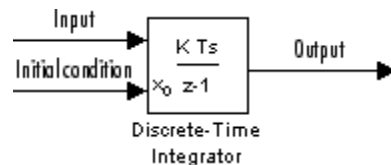

## Using the State Port

In two situations, you must use the state port instead of the output port:

- When the output of the block is fed back into the block through the reset port or the initial condition port, causing an algebraic loop. For an example of this situation, see the `sldemo_bounce` model.
- When you want to pass the state from one conditionally executed subsystem to another, which can cause timing problems. For an example of this situation, see the `sldemo_clutch` model.

You can correct these problems by passing the state through the state port rather than the output port. Although the values are the same, Simulink generates them at slightly different times, which protects your model from these problems. You output the block state by selecting the **Show state port** check box.

By default, the state port appears on the top of the block, as shown in this figure.

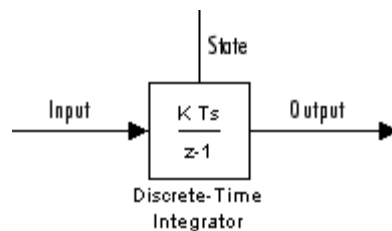

## Limiting the Integral

To prevent the output from exceeding specifiable levels, select the **Limit output** check box and enter the limits in the appropriate parameter fields. Doing so causes the block to function as a limited integrator. When the output reaches the limits, the integral action is turned off to prevent integral wind up. During a simulation, you can change the limits but you cannot change whether the output is limited. The output is determined as follows:

# Discrete-Time Integrator

---

- When the integral is less than or equal to the **Lower saturation limit** and the input is negative, the output is held at the **Lower saturation limit**.
- When the integral is between the **Lower saturation limit** and the **Upper saturation limit**, the output is the integral.
- When the integral is greater than or equal to the **Upper saturation limit** and the input is positive, the output is held at the **Upper saturation limit**.

To generate a signal that indicates when the state is being limited, select the **Show saturation port** check box. A saturation port appears below the block output port, as shown in this figure.

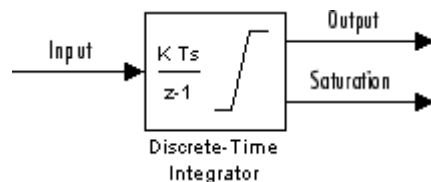

The signal has one of three values:

- 1 indicates that the upper limit is being applied.
- 0 indicates that the integral is not limited.
- -1 indicates that the lower limit is being applied.

## Resetting the State

The block can reset its state to the specified initial condition, based on an external signal. To cause the block to reset its state, select one of the **External reset** parameter choices. A trigger port appears below the block's input port and indicates the trigger type, as shown in this figure.

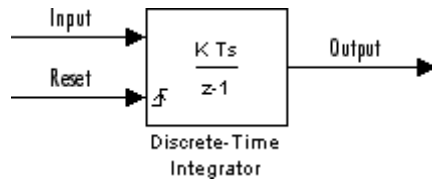

The reset port has direct feedthrough. If the block output is fed back into this port, either directly or through a series of blocks with direct feedthrough, an algebraic loop results. To resolve this loop, feed the output of the block's state port into the reset port instead. To access the block's state, select the **Show state port** check box.

## Reset Trigger Types

The **External reset** parameter lets you determine the attribute of the reset signal that triggers the reset. The trigger options include:

- rising

Resets the state when the reset signal has a rising edge. For example, the following figure shows the effect that a rising reset trigger has on backward Euler integration.

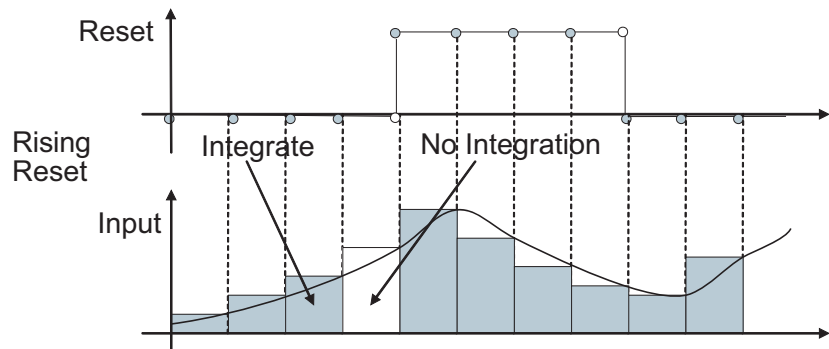

- falling

# Discrete-Time Integrator

Resets the state when the reset signal has a falling edge. For example, the following figure shows the effect that a falling reset trigger has on backward Euler integration.

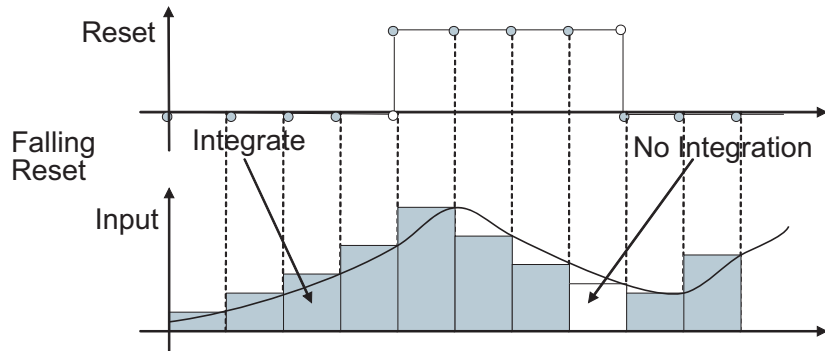

- either

Resets the state when the reset signal rises or falls. For example, the following figure shows the effect that an either reset trigger has on backward Euler integration.

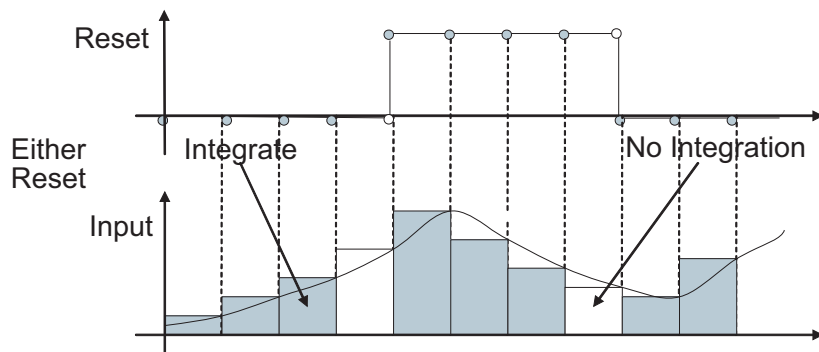

- level

# Discrete-Time Integrator

Resets and holds the output to the initial condition while the reset signal is nonzero. For example, the following figure shows the effect that a level reset trigger has on backward Euler integration.

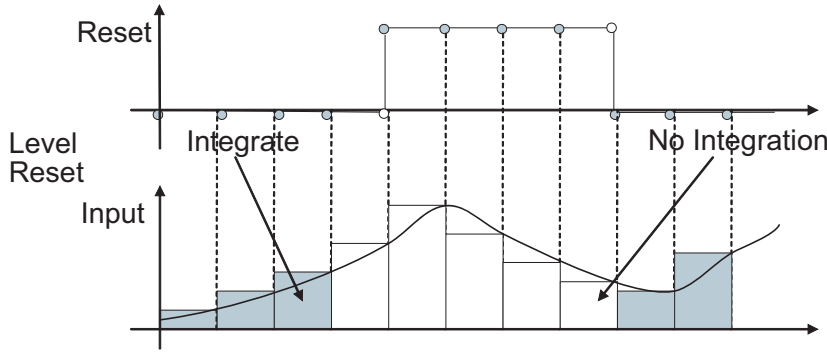

- sampled level

Resets the output to the initial condition when the reset signal is nonzero. For example, the following figure shows the effect that a sampled level reset trigger has on backward Euler integration.

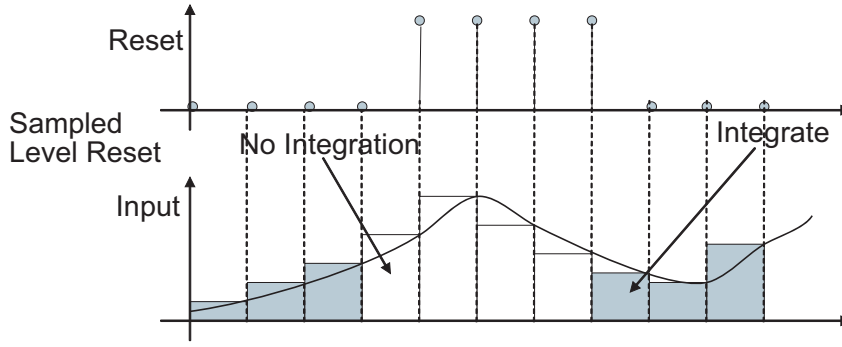

# Discrete-Time Integrator

---

---

**Note** The sampled level reset option requires fewer computations and hence is more efficient than the level reset option. However, the level reset option, but may introduces a discontinuity when integration resumes.

---

## Choosing All Options

When all options are selected, the icon looks like this.

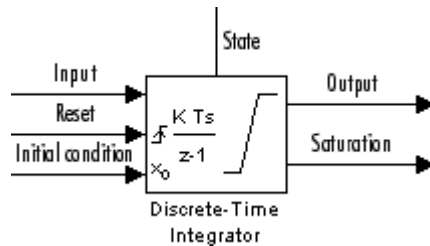

## Data Type Support

The Discrete-Time Integrator block accepts real signals of any data type supported by Simulink, including fixed-point data types.



## Parameters and Dialog Box

The **Main** pane of the Discrete-Time Integrator block dialog appears as follows:

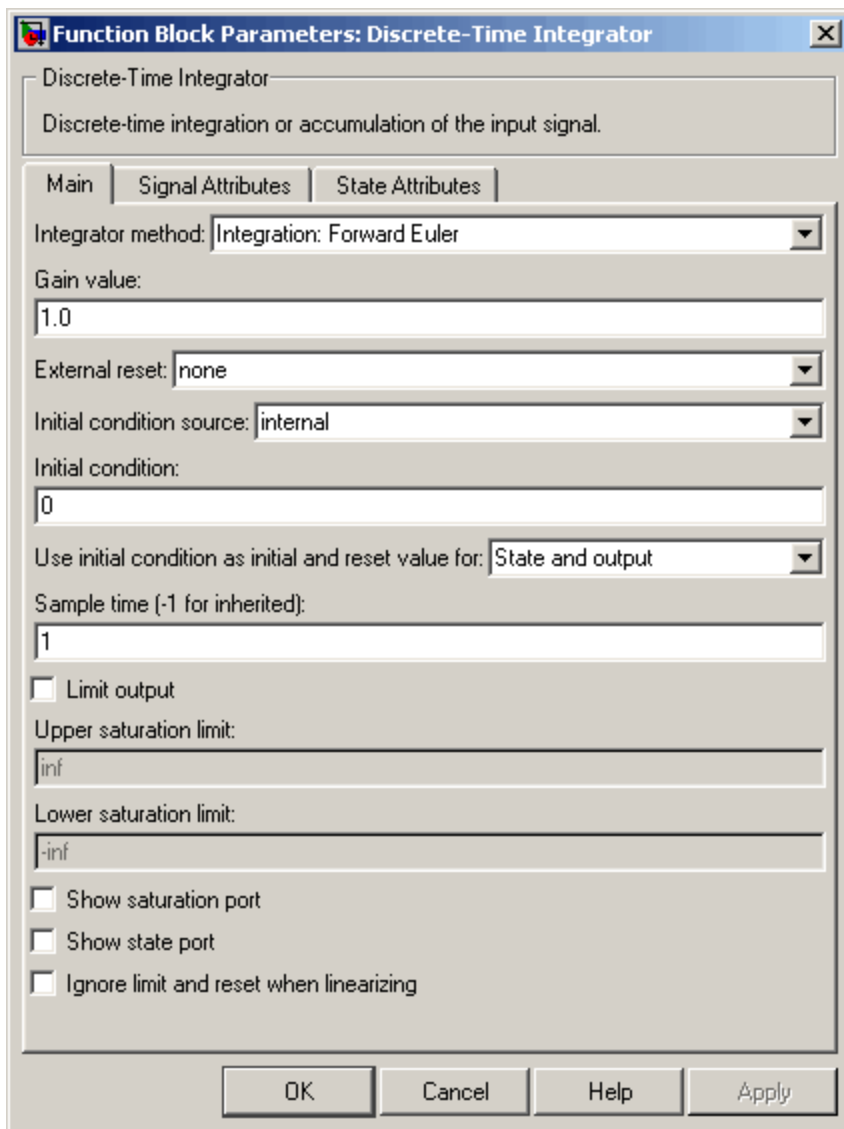

# Discrete-Time Integrator

---

## Integrator method

Specify the integration or accumulation method.

## Gain value

Specify a value by which to multiply the integrator input. Specifying a value other than 1.0 (the default) is semantically equivalent to connecting a signal to the input of the integrator via a Gain block, i.e., to

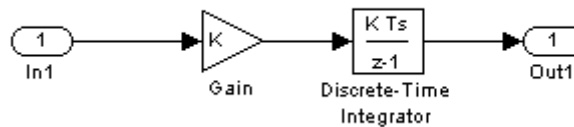

Using this parameter to specify the input gain eliminates a multiplication operation in the generated code. Realizing this benefit, however, requires that this parameter be nontunable. Accordingly, the Real-Time Workshop generates a warning during code generation if the **Model Parameter Configuration** dialog box for this model declares this parameter to be tunable. If you want to tune the input gain, set this parameter to 1.0 and use an external Gain block to specify the input gain.

## External reset

Resets the states to their initial conditions when a trigger event occurs in the reset signal. See “Resetting the State” on page 2-230 for more information.

## Initial condition source

Gets the states’ initial conditions from the **Initial condition** parameter (internal) or from an external block (external). Simulink does not allow the initial condition of this block to be inf or NaN.

## Initial condition

The states’ initial conditions. This parameter is only available if the **Initial condition source** parameter is set to internal.

Simulink does not allow the initial condition of this block to be `inf` or `NaN`.

## Use **initial condition as initial and reset value for**

When you set this parameter to `State and output`,

$$y(0) = IC$$

$$x(0) = IC$$

or at reset

$$y(n) = IC$$

$$x(n) = IC$$

When you set this parameter to `State only (most efficient)`,

$$x(0) = IC$$

or at reset

$$x(n) = IC$$

## Sample time

The time interval between samples. The default is 1. In accumulation mode, the sample time specifies when the block's output is computed. See *Specifying Sample Time* in the "How Simulink Works" chapter of the *Using Simulink* documentation.

## Limit output

If selected, limits the block's output to a value between the **Lower saturation limit** and **Upper saturation limit** parameters.

## Upper saturation limit

The upper limit for the integral. This parameter is only available if you select the **Limit output** parameter.

# Discrete-Time Integrator

---

## **Lower saturation limit**

The lower limit for the integral. This parameter is only available if you select the **Limit output** parameter.

## **Show saturation port**

If selected, adds a saturation output port to the block.

## **Show state port**

If selected, adds an output port to the block for the block's state.

## **Ignore limit and reset when linearizing**

Select this option to cause Simulink linearization commands to treat this block as unresettable and as having no limits on its output, regardless of the settings of the block's reset and output limitation options. This allows you to linearize a model around an operating point that causes the integrator to reset or saturate.

The **Signal Attributes** pane of the Discrete-Time Integrator block dialog appears as follows:

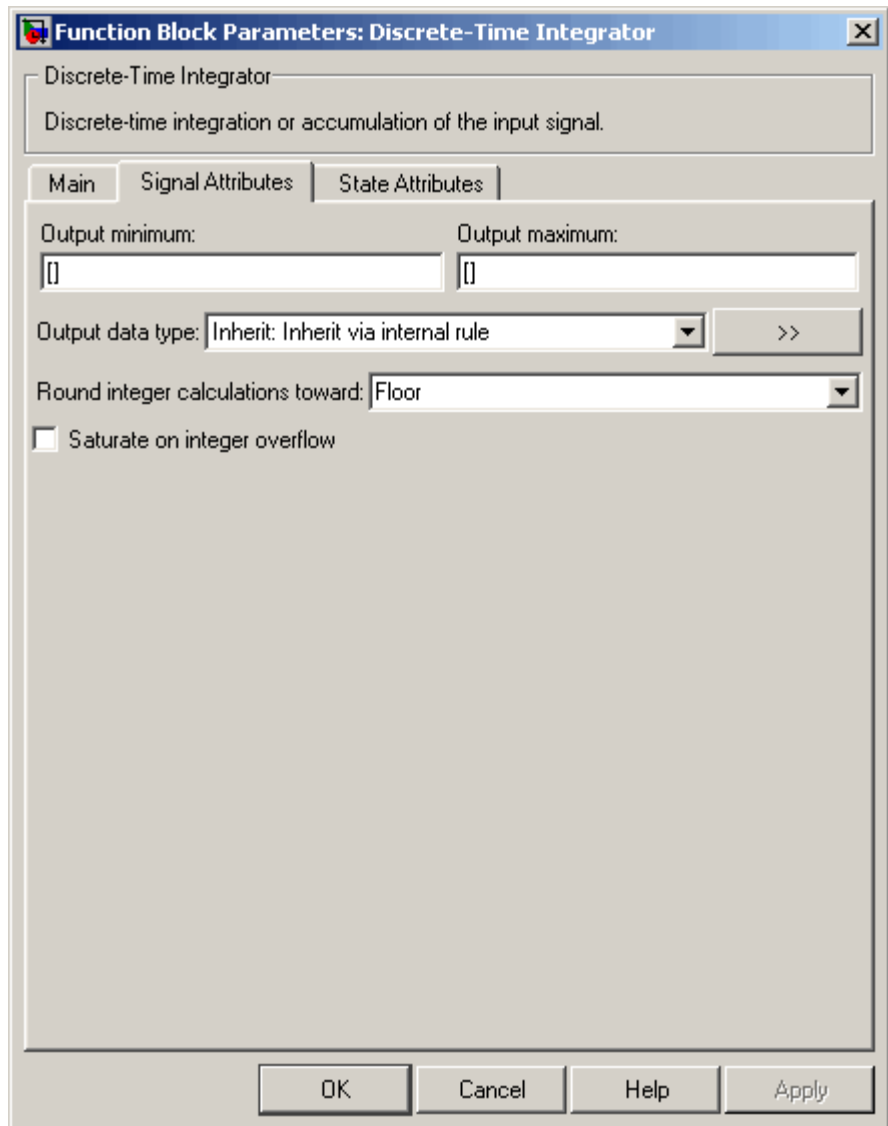

# Discrete-Time Integrator

---

## Output minimum

Specify the minimum value that the block should output. The default value, [], is equivalent to  $-\text{Inf}$ . Simulink uses this value to perform:

- Simulation range checking (see “Checking Signal Ranges”)
- Automatic scaling of fixed-point data types

## Output maximum

Specify the maximum value that the block should output. The default value, [], is equivalent to  $\text{Inf}$ . Simulink uses this value to perform:

- Simulation range checking (see “Checking Signal Ranges”)
- Automatic scaling of fixed-point data types

## Output data type

Specify the output data type. You can set it to:

- A rule that inherits a data type, for example, `Inherit: Inherit via back propagation`
- The name of a built-in data type, for example, `single`
- The name of a data type object, for example, a `Simulink.NumericType` object
- An expression that evaluates to a data type, for example, `float('single')`

Click the **Show data type assistant** button  to display the **Data Type Assistant**, which helps you set the **Output data type** parameter.

See “Specifying Block Output Data Types” in *Using Simulink* for more information.

## Lock output scaling against changes by the autoscaling tool

Select to lock scaling of outputs. This parameter is visible only if you enter an expression for the **Output data type** parameter.

## Round integer calculations toward

Select the rounding mode for fixed-point operations.

## Saturate on integer overflow

Select to have overflows saturate.

The **State Attributes** pane of this block pertains to code generation and has no effect on model simulation. See “Block State Storage and Interfacing” in the Real-Time Workshop User’s Guide for more information.

## Characteristics

Direct Feedthrough	Yes, of the reset and external initial condition source ports. The input has direct feedthrough for every integration method except forward Euler and accumulation forward Euler.
Sample Time	Specified in the <b>Sample time</b> parameter
Scalar Expansion	Yes, of parameters
States	Inherited from driving block and parameter
Dimensionalized	Yes
Zero Crossing	No

# Discrete Transfer Fcn

---

**Purpose** Implement discrete transfer function

**Library** Discrete

**Description** The Discrete Transfer Fcn block implements the  $z$ -transform transfer function described by the following equations:

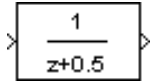

$$H(z) = \frac{num(z)}{den(z)} = \frac{num_0 z^n + num_1 z^{n-1} + \dots + num_m z^{n-m}}{den_0 z^n + den_1 z^{n-1} + \dots + den_n}$$

where  $m+1$  and  $n+1$  are the number of numerator and denominator coefficients, respectively.  $num$  and  $den$  contain the coefficients of the numerator and denominator in descending powers of  $z$ .  $num$  can be a vector or matrix,  $den$  must be a vector, and both are specified as parameters on the block dialog box. The order of the denominator must be greater than or equal to the order of the numerator.

Block input is scalar; output width is equal to the number of rows in the numerator.

The Discrete Transfer Fcn block represents the method typically used by control engineers, representing discrete systems as polynomials in  $z$ . The Discrete Filter block represents the method typically used by signal processing engineers, who describe digital filters using polynomials in  $z^{-1}$  (the delay operator). The two methods are identical when the numerator is the same length as the denominator.

The Discrete Transfer Fcn block displays the numerator and denominator within its icon depending on how they are specified. See Transfer Fcn for more information.

**Data Type Support** The Discrete Transfer Function block accepts and outputs real signals of type single or double.



## Parameters and Dialog Box

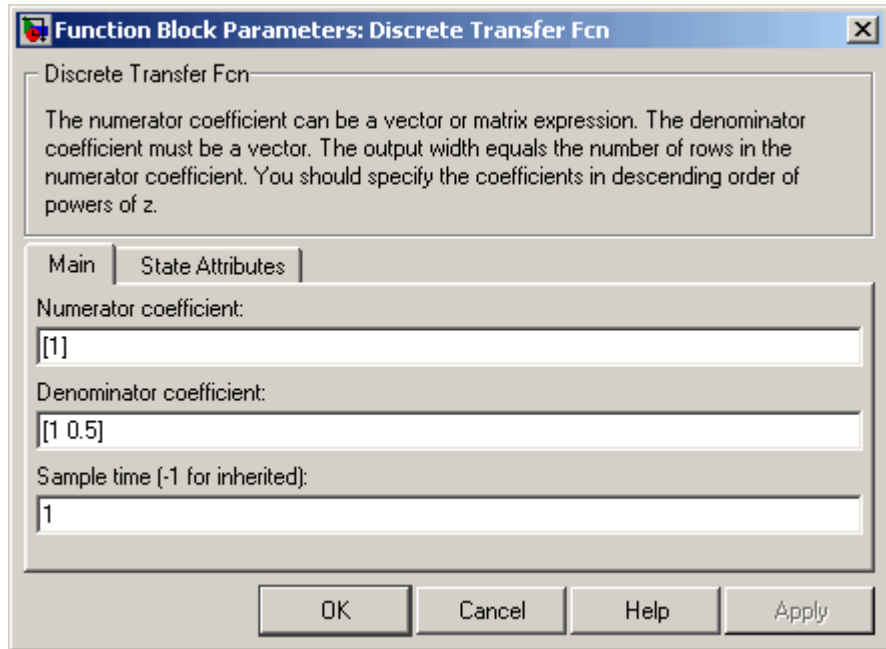

### Numerator coefficient

The row vector of numerator coefficients. A matrix with multiple rows can be specified to generate multiple output. The default is [1].

### Denominator coefficient

The row vector of denominator coefficients. The default is [1 0.5].

### Sample time

The time interval between samples. The default is 1. See Specifying Sample Time in the “How Simulink Works” chapter of the Using Simulink documentation.

The **State Attributes** pane of this block pertains to code generation and has no effect on model simulation. See “Block State Storage

# Discrete Transfer Fcn

---

and Interfacing” in the Real-Time Workshop User’s Guide for more information.

## Characteristics

Direct Feedthrough	Only if the lengths of the <b>Numerator</b> and <b>Denominator</b> parameters are equal
Sample Time	Specified in the <b>Sample time</b> parameter
Scalar Expansion	No
States	Length of <b>Denominator</b> parameter -1
Dimensionalized	No
Zero Crossing	No

**Purpose** Model system defined by zeros and poles of discrete transfer function

**Library** Discrete

**Description** The Discrete Zero-Pole block models a discrete system defined by the zeros, poles, and gain of a  $z$ -domain transfer function. This block assumes that the transfer function has the following form

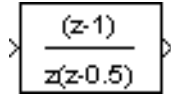

$$H(z) = K \frac{Z(z)}{P(z)} = K \frac{(z - Z_1)(z - Z_2) \dots (z - Z_m)}{(z - P_1)(z - P_2) \dots (z - P_n)}$$

where  $Z$  represents the zeros vector,  $P$  the poles vector, and  $K$  the gain. The number of poles must be greater than or equal to the number of zeros ( $n \geq m$ ). If the poles and zeros are complex, they must be complex conjugate pairs.

The block displays the transfer function depending on how the parameters are specified. See Zero-Pole for more information.

**Data Type Support** The Discrete Zero-Pole block accepts and outputs real signals of type double.

# Discrete Zero-Pole

## Parameters and Dialog Box

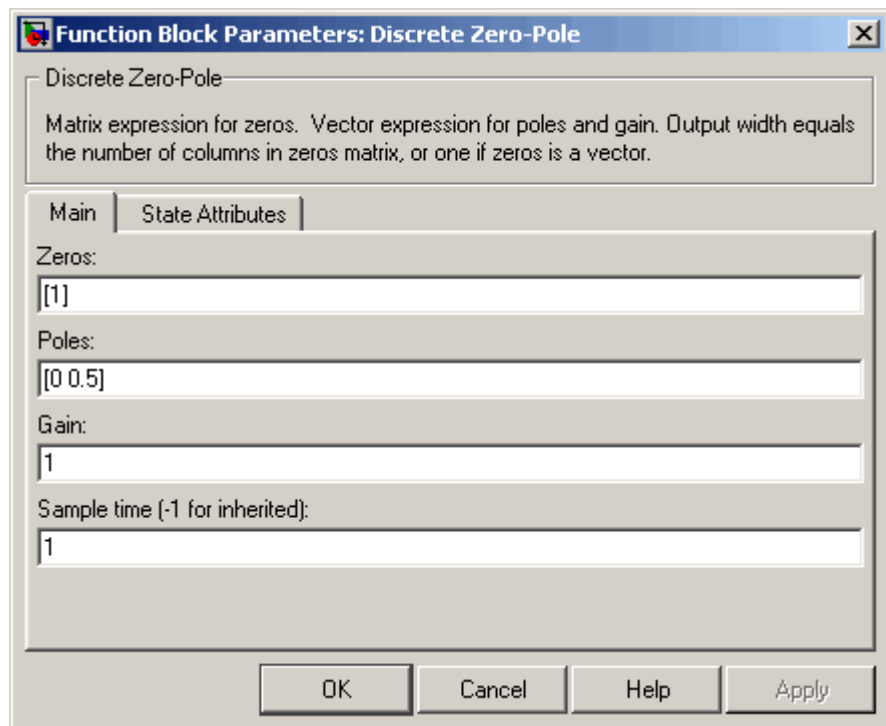

### Zeros

The matrix of zeros. The default is [ 1 ].

### Poles

The vector of poles. The default is [ 0 0.5 ].

### Gain

The gain. The default is 1.

### Sample time

The time interval between samples. See Specifying Sample Time in the "How Simulink Works" chapter of the Using Simulink documentation.

The **State Attributes** pane of this block pertains to code generation and has no effect on model simulation. See “Block State Storage and Interfacing” in the Real-Time Workshop User’s Guide for more information.

## Characteristics

Direct Feedthrough	Yes, if the number of zeros and poles are equal
Sample Time	Specified in the <b>Sample time</b> parameter
Scalar Expansion	No
States	Length of <b>Poles</b> vector
Dimensionalized	No
Zero Crossing	No

# Display

---

**Purpose** Show value of input

**Library** Sinks

**Description** The Display block shows the value of its input on its icon.

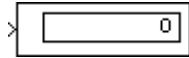

You control the display format using the **Format** parameter:

- `short` — displays a 5-digit scaled value with fixed decimal point
- `long` — displays a 15-digit scaled value with fixed decimal point
- `short_e` — displays a 5-digit value with a floating decimal point
- `long_e` — displays a 16-digit value with a floating decimal point
- `bank` — displays a value in fixed dollars and cents format (but with no \$ or commas)
- `hex` (Stored Integer) — displays the stored integer value of a fixed-point input in hexadecimal format
- `binary` (Stored Integer) — displays the stored integer value of a fixed-point input in binary format
- `decimal` (Stored Integer) — displays the stored integer value of a fixed-point input in decimal format
- `octal` (Stored Integer) — displays the stored integer value of a fixed-point input in octal format

The amount of data displayed and the time steps at which the data is displayed are determined by the **Decimation** block parameter and the `SampleTime` property:

- The **Decimation** parameter enables you to display data at every  $n$ th sample, where  $n$  is the decimation factor. The default decimation, 1, displays data at every time step.
- The `SampleTime` property, settable with `set_param`, enables you to specify a sampling interval at which to display points. This property is useful when you are using a variable-step solver where the interval

between time steps might not be the same. The default value of -1 causes the block to ignore the sampling interval when determining the points to display.

If the block input is an array, you can resize the block to show more than just the first element. You can resize the block vertically or horizontally; the block adds display fields in the appropriate direction. A black triangle indicates that the block is not displaying all input array elements. For example, the following figure shows a model that passes a vector (1-D array) to a Display block. The black triangle on the Display block indicates more data to be displayed.

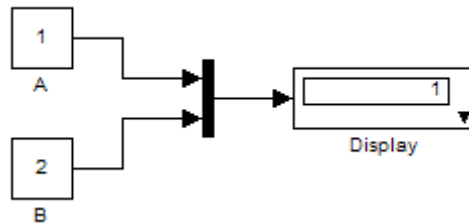

The following figure shows the resized block displaying both input elements.

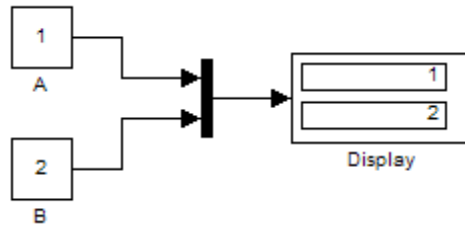

---

**Note** The Display block shows only the first 200 elements of a one-dimensional (vector) signal and only the first 20 rows and 10 columns of a two-dimensional (matrix) signal.

---

# Display

---

## Display Abbreviations

The following abbreviations appear on the Display block to help you identify the format of the number being displayed.

Symbol	Description
(SI)	This alerts you to the fact that the number being displayed is the stored integer value. This symbol does not appear when the signal is of an integer data type.
hex	The number being displayed is in hexadecimal format.
bin	The number being displayed is in binary format.
oct	The number being displayed is in octal format.

## Floating Display

To use the block as a floating display, select the **Floating display** check box. The block's input port disappears and the block displays the value of the signal on a selected line. If you select the **Floating display** option, you must turn off the signal storage reuse feature in Simulink. See "Signal storage reuse" in the "Running Simulations" chapter of the Using Simulink documentation.

---

**Note** The floating display does not support multidimensional signals. If you connect a multidimensional signal to a floating display, the display generates an error.

---

## Data Type Support

The Display block accepts and outputs real or complex signals of any data type supported by Simulink, including fixed-point data types.

For a discussion on the data types supported by Simulink, see "Data Types Supported by Simulink" in the "Working with Data" chapter of the Using Simulink documentation.



## Parameters and Dialog Box

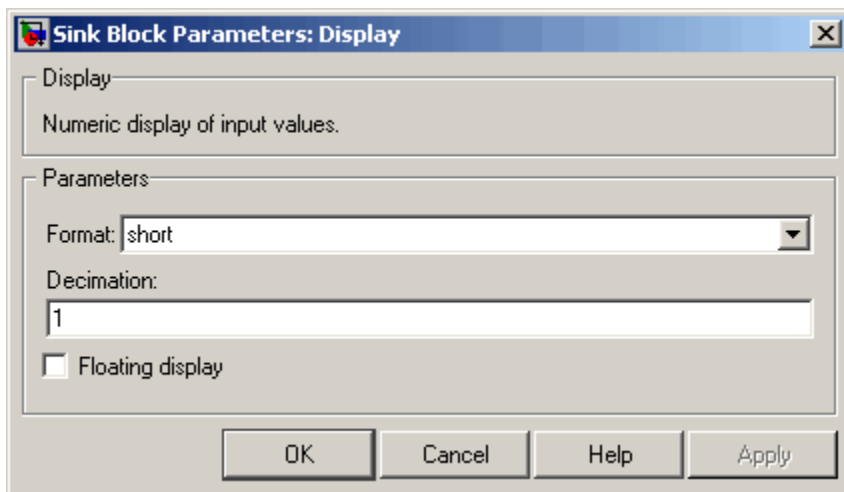

### Format

Specify the format of the data displayed, as discussed in Description. The default is short.

### Decimation

Specify how often to display data. The default value, 1, displays every input point.

### Floating display

If selected, the block's input port disappears, which enables the block to be used as a floating Display block.

## Characteristics

SampleTime	Use set_param to specify the SampleTime property
Dimensionalized	Yes

# Divide

---

**Purpose** Multiply or divide inputs

**Library** Math Operations

**Description** The Divide block is an implementation of the Product block. See Product for more information.

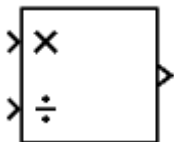

---

<b>Purpose</b>	Create text that documents model and save text with model
<b>Library</b>	Model-Wide Utilities
<b>Description</b>	<p>The DocBlock allows you to create and edit text that documents a model, and save that text with the model. Double-clicking an instance of the block creates a temporary file containing the text associated with this block and opens the file in an editor. Use the editor to modify the text and save the file. Simulink stores the contents of the saved file in the model file.</p> <p>The DocBlock supports HTML, Rich Text Format (RTF), and ASCII text document types. The default editors for these different document types are</p> <ul style="list-style-type: none"><li>• HTML — Microsoft Word (if available). Otherwise, the DocBlock opens HTML documents using the editor specified on the <b>Editor/Debugger Preferences</b> pane of the Preferences dialog box.</li><li>• RTF — Microsoft Word (if available). Otherwise, the DocBlock opens RTF documents using the editor specified on the <b>Editor/Debugger Preferences</b> pane of the Preferences dialog box.</li><li>• Text — The DocBlock opens text documents using the editor specified on the <b>Editor/Debugger Preferences</b> pane of the Preferences dialog box.</li></ul> <p>Use the docblock command to change the default editors.</p> <hr/> <p><b>Note</b> Simulink embeds DocBlock documents in the model file (see Chapter 9, “Model File Format”). This can greatly increase the size of a model file, for example, if the RTF document contains bitmapped images, and can require more time to open and save the model.</p> <hr/>
<b>Data Type Support</b>	Not applicable.

## Parameters and Dialog Box

Double-clicking an instance of the DocBlock opens an editor. To access the DocBlock parameter dialog box, select the block in the Model Editor and then select **Mask Parameters** from either the **Edit** menu or the block's context menu.

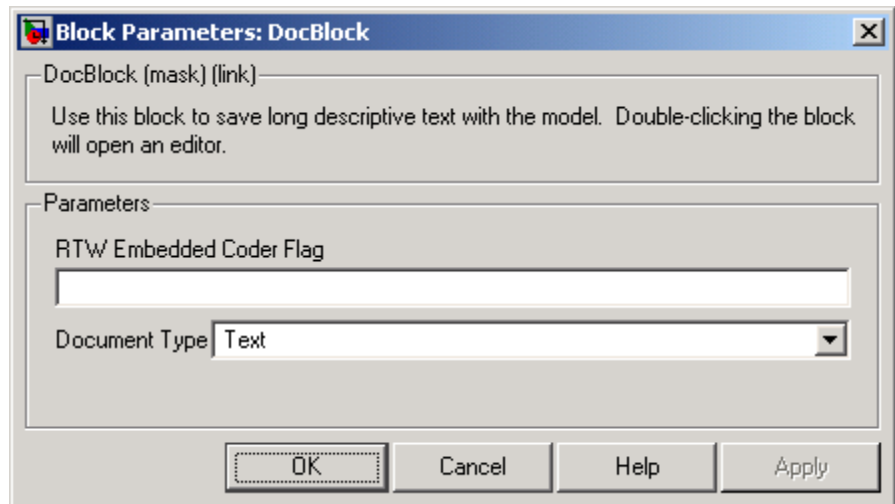

**RTW Embedded Coder Flag** (Real-Time Workshop Embedded Coder license required)

Enter a template symbol name in this field. Real-Time Workshop Embedded Coder uses this symbol to add comments to the code generated from the model. See “Adding Global Comments” under “Module Packaging Features” in the Real-Time Workshop Embedded Coder documentation for more information.

### Document Type

Specifies the type of document associated with the DocBlock. The options are

- Text (the default)
- RTF
- HTML

**Characteristics** Not applicable

# Dot Product

---

**Purpose** Generate dot product of two vectors

**Library** Math Operations

**Description** The Dot Product block generates the dot product of the vectors at its inputs. The scalar output,  $y$ , is equal to the MATLAB operation

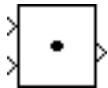

$$y = \text{sum}(\text{conj}(u1) .* u2)$$

where  $u1$  and  $u2$  represent the vectors at the block's top and bottom inputs, respectively. (See "Changing the Orientation of a Block" in Using Simulink for a description of the port order for various block orientations.) The inputs can be vectors, column vectors (single-column matrices), or scalars. If both inputs are vectors or column vectors, they must be the same length. If  $u1$  and  $u2$  are both column vectors, the block outputs the equivalent of the MATLAB expression  $u1' * u2$ .

The elements of the input vectors can be real- or complex-valued signals. The signal type (complex or real) of the output depends on the signal types of the inputs.

Input 1	Input 2	Output
real	real	real
real	complex	complex
complex	real	complex
complex	complex	complex

To perform element-by-element multiplication without summing, use the Product block.

**Data Type Support** The Dot Product block accepts and outputs signals of any data type supported by Simulink, including fixed-point data types.

For a discussion on the data types supported by Simulink, see "Data Types Supported by Simulink".

## Parameters and Dialog Box

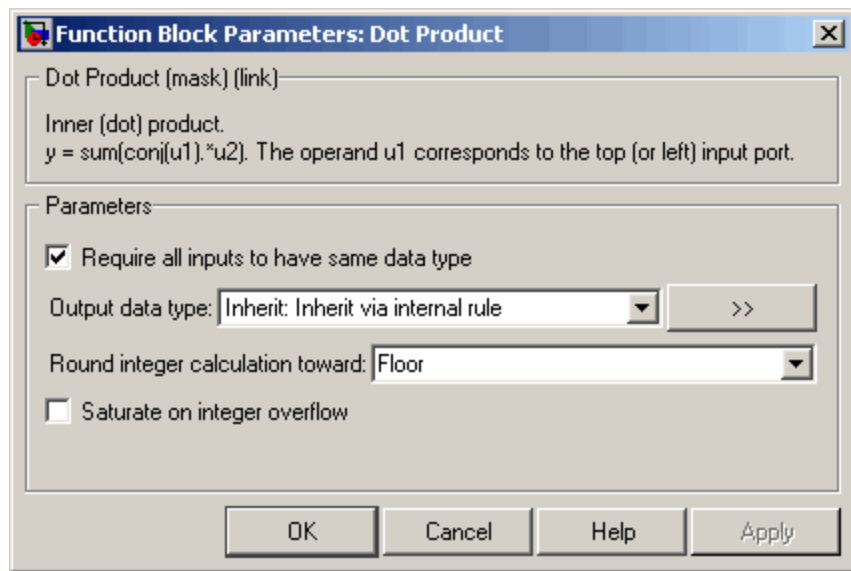

### Require all inputs to have same data type

Select to require all inputs to have the same data type.

### Output data type

Specify the output data type. You can set it to:

- A rule that inherits a data type, for example, Inherit: Inherit via back propagation
- The name of a built-in data type, for example, single
- The name of a data type object, for example, a Simulink.NumericType object
- An expression that evaluates to a data type, for example, float('single')

Click the **Show data type assistant** button  to display the **Data Type Assistant**, which helps you set the **Output data type** parameter.

# Dot Product

---

See “Specifying Block Output Data Types” in *Using Simulink* for more information.

**Lock output scaling against changes by the autoscaling tool**

Select to lock scaling of outputs. This parameter is visible only if you enter an expression for the **Output data type** parameter.

**Round integer calculations toward**

Select the rounding mode for fixed-point operations.

**Saturate on integer overflow**

Select to have overflows saturate.

**Characteristics**

Direct Feedthrough	Yes
Sample Time	Inherited from driving block
Scalar Expansion	No
States	0
Dimensionalized	Yes
Zero Crossing	No



**Purpose** Include MATLAB code in models that generate embeddable C code

**Library** User-Defined Functions

**Description** An Embedded MATLAB Function block lets you compose a MATLAB function in Simulink like the following example:

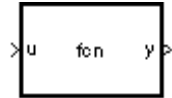

Embedded  
MATLAB Function

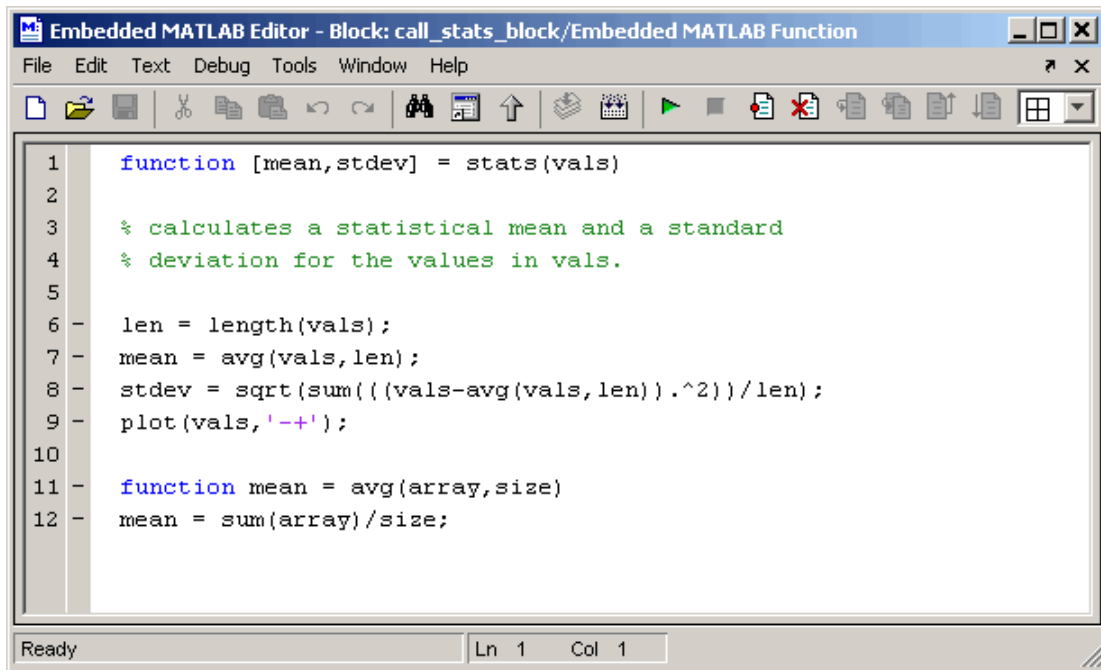
A screenshot of the Embedded MATLAB Editor window. The title bar reads 'Embedded MATLAB Editor - Block: call\_stats\_block/Embedded MATLAB Function'. The menu bar includes 'File', 'Edit', 'Text', 'Debug', 'Tools', 'Window', and 'Help'. The toolbar contains various icons for file operations, editing, and execution. The main text area contains the following MATLAB code:

```
1 function [mean,stdev] = stats(vals)
2
3 % calculates a statistical mean and a standard
4 % deviation for the values in vals.
5
6 len = length(vals);
7 mean = avg(vals,len);
8 stdev = sqrt(sum((vals-avg(vals,len)).^2)/len);
9 plot(vals,'-+');
10
11 function mean = avg(array,size)
12 mean = sum(array)/size;
```

The status bar at the bottom shows 'Ready' and 'Ln 1 Col 1'.

The MATLAB function you create executes for simulation and generates code for a Real-Time Workshop target. If you are new to Simulink and MATLAB, see “Using the Embedded MATLAB Function Block”

# Embedded MATLAB Function

in Simulink documentation for a comprehensive overview including a step-by-step example.

You create the MATLAB function in the **Embedded MATLAB Editor**. To learn about this editor's capabilities see "The Embedded MATLAB Function Editor".

You specify input and output data to the Embedded MATLAB Function block in the function header as arguments and return values. Notice that the argument and return values of the preceding example function correspond to the inputs and outputs of the block in Simulink.

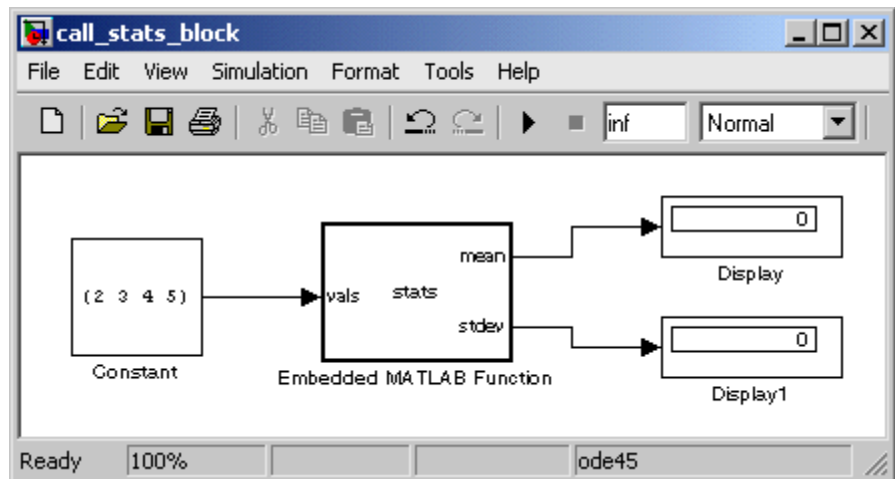

The Embedded MATLAB Function block supports a subset of the language for which it can generate efficient embeddable code. For details about the Embedded MATLAB subset, see "Working with Embedded MATLAB" in the Embedded MATLAB documentation.

To generate embeddable code, the Embedded MATLAB Function block relies on an analysis that determines the size and class of each variable. This analysis imposes the following additional restrictions on the way in which the above features may be used.

- 1 The first definition of a variable must define both its class and size. The class and size of a variable cannot be changed once it has been set.
- 2 Whether data is complex or real is determined by the first definition. Subsequent definitions may assign real numbers into complex storage but may not assign complex numbers into real storage.

The preceding limitations require you to code in a certain style. Some common idioms to avoid are listed in “Using Matrix Indexing Operations” and “Working with Complex Numbers” in the Embedded MATLAB documentation.

In addition to language restrictions, Embedded MATLAB Function blocks support only a subset of the functions available in MATLAB. A list of supported functions is given in the “Embedded MATLAB Function Library Reference” in the Embedded MATLAB documentation. These functions include functions in common categories like

- Arithmetic functions like plus, minus, and power
- Matrix operations like size, and length
- Advanced matrix operations like lu, inv, svd, and chol
- Trigonometric functions like sin, cos, sinh, and cosh

to name just a few. See “Embedded MATLAB Function Library — Categorical List” in the Embedded MATLAB documentation for a complete list of function categories.

---

**Note** Although Embedded MATLAB attempts to produce exactly the same results as MATLAB, there will be occasions when they will differ due to rounding errors. These numerical differences, which may be a few eps initially, might be magnified after repeated operations. Reliance on the behavior of nan is not recommended. Different C compilers may yield different results for the same computation.

---

# Embedded MATLAB Function

---

To support visualization of data, Embedded MATLAB Function blocks support calls to MATLAB functions for simulation only. See “Calling MATLAB Functions” in the Embedded MATLAB documentation to understand some of the limitations of this capability, and how it is integrated into Embedded MATLAB analysis. If these calls do not directly affect any of the Simulink inputs or outputs, they are eliminated from the generated code when generating code with Real-Time Workshop.

You can declare an Embedded MATLAB input to be a Simulink parameter instead of a port in the Model Explorer. The Embedded MATLAB Function block also supports inheritance of types and size for inputs, outputs, and parameters. If needed, you can also set these explicitly using the Model Explorer. See “Typing Function Arguments”, “Sizing Function Arguments”, and “Parameter Arguments in Embedded MATLAB Functions”, for more detailed descriptions of variables that you use in Embedded MATLAB Functions.

Note that recursive calls are not allowed in Embedded MATLAB.

## Data Type Support

The Embedded MATLAB Function block accepts inputs of any type supported by Simulink. For a discussion on the variable types supported by Embedded MATLAB functions in Simulink, refer to “Data Types Supported by Simulink” in the Simulink documentation.

For more information on fixed-point support in Embedded MATLAB, refer to “Working with the Fixed-Point Embedded MATLAB™ Subset” in the Fixed-Point Toolbox documentation.

The Embedded MATLAB Function block supports Simulink frames. See “Frame-Based Signals” in the documentation for Signal Processing Blockset for more information.

## Parameters and Dialog Box

The **Block Parameters** dialog box for an Embedded MATLAB Function block is identical to the **Block Parameters** dialog box for a Subsystem block. See the reference page for the Subsystem, Atomic Subsystem, CodeReuse Subsystem blocks for an identification of each field.

## Characteristics

Direct Feedthrough	Yes
Sample Time	Specified in the <b>Sample time</b> parameter
Scalar Expansion	Yes
Dimensionalized	Yes
Multidimensionalized	Yes
Zero Crossing	No

# Enable

---

**Purpose** Add enabling port to subsystem

**Library** Ports & Subsystems

## Description



Adding an Enable block to a subsystem makes it an enabled subsystem. An enabled subsystem executes while the input received at the Enable port is greater than zero.

At the start of simulation, Simulink initializes the states of blocks inside an enabled subsystem to their initial conditions. When an enabled subsystem restarts (executes after having been disabled), the **States when enabling** parameter determines what happens to the states of blocks contained in the enabled subsystem:

- **reset** resets the states to their initial conditions (zero if not defined).
- **held** holds the states at their previous values.

You can output the enabling signal by selecting the **Show output port** check box. Selecting this option allows the system to process the enabling signal.

A subsystem can contain no more than one Enable block.

## Data Type Support

The data type of the input of the Enable port, i.e., the enable port that appears on the subsystem in which the Enable block resides, can be any data type supported by Simulink, including fixed-point data types.

For a discussion on the data types supported by Simulink, see “Data Types Supported by Simulink” in the “Working with Data” chapter of the Using Simulink documentation.

## Parameters and Dialog Box

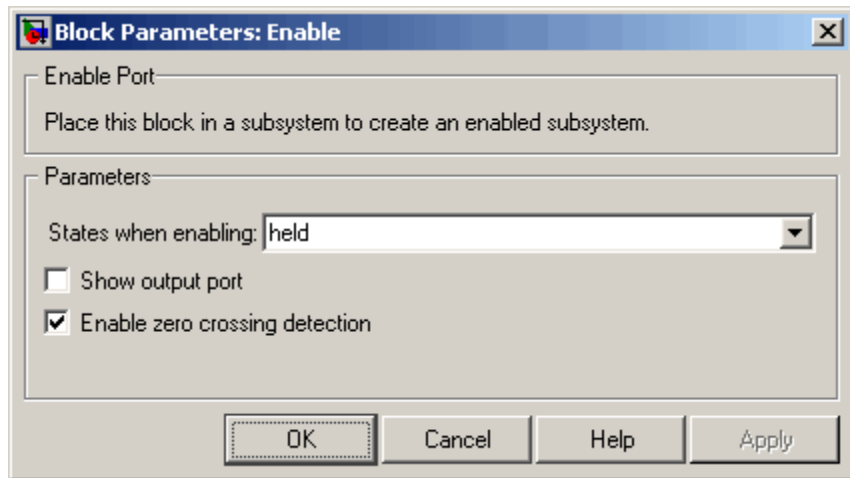

### States when enabling

Specifies how to handle internal states when the subsystem becomes reenabled.

### Show output port

If selected, Simulink draws the Enable block output port and outputs the enabling signal.

### Enable zero crossing detection

Select to enable zero crossing detection. For more information, see “Zero-Crossing Detection” in the “How Simulink Works” chapter of the Using Simulink documentation.

## Characteristics

Sample Time	Determined by the signal at the enable port
Dimensionalized	Yes
Zero Crossing	Yes, if enabled.

# Enabled and Triggered Subsystem

---

**Purpose** Represent subsystem whose execution is enabled and triggered by external input

**Library** Ports & Subsystems

**Description** This block is a Subsystem block that is preconfigured to serve as the starting point for creating an enabled and triggered subsystem. For more information, see “Triggered and Enabled Subsystems” in the online Simulink help.

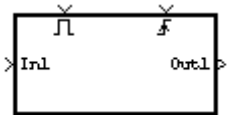



<b>Purpose</b>	Represent subsystem whose execution is enabled by external input
<b>Library</b>	Ports & Subsystems
<b>Description</b>	This block is a Subsystem block that is preconfigured to serve as the starting point for creating an enabled subsystem. For more information, see “Enabled Subsystems” in the “Creating a Model” chapter of the Using Simulink documentation.

# Environment Controller

---

**Purpose** Create branches of block diagram that apply only to simulation or only to code generation

**Library** Signal Routing

**Description** This block outputs the signal at its Sim port only if the model that contains it is being simulated. It outputs the signal at its RTW port only if code is being generated from the model. This allows you to create branches of a model's block diagram that apply only to simulation or only to code generation. The table below describes various scenarios where either the Sim or RTW port applies.

Scenario	Output
Normal mode simulation	Sim
Accelerator mode simulation	Sim
Simulation of a referenced model	Sim
External mode simulation	RTW
Standard code generation	RTW
Code generation of a referenced model	RTW
Processor-in-the-loop target code generation	Sim

Real-Time Workshop does not generate code for blocks connected to the Sim port. If you enable block reduction optimization (see “Block reduction” in the online Simulink documentation), Simulink eliminates blocks in the branch connected to the block's RTW port when compiling the model for simulation.

---

**Note** Real-Time Workshop eliminates the blocks connected to the Sim branch only if the Sim branch has the same signal dimensions as the RTW branch. Regardless of whether it eliminates the Sim branch, Real-Time Workshop uses the sample times on the Sim branch as well as the RTW branch to determine the fundamental sample time of the generated code and may, in some cases, generate sample-time handling code that applies only to sample times specified on the Sim branch.

---

## Data Type Support

The Environment Controller block accepts signals of any numeric or data type. It outputs the type at its input.

## Parameters and Dialog Box

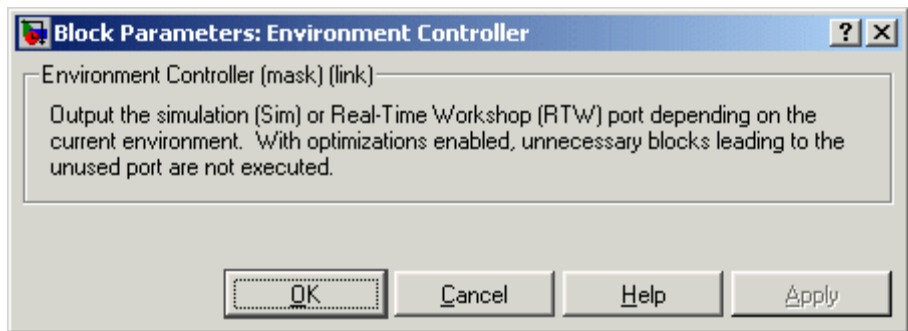

## Characteristics

Multidimensionalized	Yes
----------------------	-----

# Extract Bits

---

**Purpose** Output selection of contiguous bits from input signal

**Library** Logic and Bit Operations

## Description



The Extract Bits block allows you to output a contiguous selection of bits from the stored integer value of the input signal. The **Bits to extract** parameter defines the method by which you select the output bits.

- Select `Upper half` to output the half of the input bits that contain the most significant bit. If there is an odd number of bits in the input signal, the number of output bits is given by the equation

$$\text{number of output bits} = \text{ceil}(\text{number of input bits}/2)$$

- Select `Lower half` to output the half of the input bits that contain the least significant bit. If there is an odd number of bits in the input signal, the number of output bits is given by the equation

$$\text{number of output bits} = \text{ceil}(\text{number of input bits}/2)$$

- Select `Range starting with most significant bit` to output a certain number of the most significant bits of the input signal. Specify the number of most significant bits to output in the **Number of bits** parameter.
- Select `Range ending with least significant bit` to output a certain number of the least significant bits of the input signal. Specify the number of least significant bits to output in the **Number of bits** parameter.
- Select `Range of bits` to indicate a series of contiguous bits of the input to output in the **Bit indices** parameter. You indicate the range in `[start end]` format, and the indices of the input bits are labeled contiguously starting at 0 for the least significant bit.

## Data Type Support

The Extract Bits block accepts inputs of any data type supported by Simulink, including fixed-point data types. Floating-point inputs are passed through the block unchanged. Boolean inputs are treated as uint8 signals.

For a discussion on the data types supported by Simulink, see “Data Types Supported by Simulink” in the Simulink documentation.

## Parameters and Dialog Box

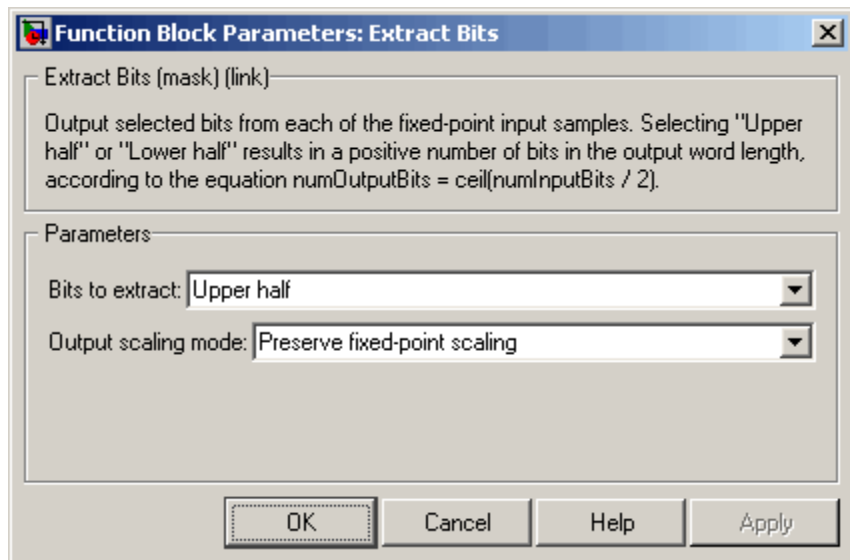

### Bits to extract

Select the mode by which to extract bits from the input signal, as discussed in Description.

### Number of bits

(Not shown on dialog above.) Select the number of bits to output from the input signal.

This parameter is only visible if you select Range starting with most significant bit or Range ending with least significant bit for the **Bits to extract** parameter.

# Extract Bits

---

## Bit indices

(Not shown on dialog above.) Specify a contiguous range of bits of the input signal to output. Specify the range in [start end] format. The indices are assigned to the input bits starting with 0 at the least significant bit.

This parameter is only visible if you select Range of bits for the **Bits to extract** parameter.

## Output scaling mode

Select the scaling mode to use on the output bits selection:

- When you select Preserve fixed-point scaling, the fixed-point scaling of the input is used to determine the output scaling during the data type conversion.
- When you select Treat bit field as an integer, the fixed-point scaling of the input is ignored, and only the stored integer is used to compute the output data type.

## Example

Consider an input signal that is represented in binary by 110111001:

- If you select Upper half for the **Bits to extract** parameter, the output is 11011 in binary.
- If you select Lower half for the **Bits to extract** parameter, the output is 11001 in binary.
- If you select Range starting with most significant bit for the **Bits to extract** parameter, and specify 3 for the **Number of bits** parameter, the output is 110 in binary.
- If you select Range ending with least significant bit for the **Bits to extract** parameter, and specify 8 for the **Number of bits** parameter, the output is 10111001 in binary.
- If you select Range of bits for the **Bits to extract** parameter, and specify [4 7] for the **Bit indices** parameter, the output is 1011 in binary.

**Characteristics**

Direct Feedthrough	Yes
Sample Time	Inherited
Scalar Expansion	N/A
States	None
Dimensionalized	Inherited
Zero Crossing	No

**Purpose** Apply specified expression to input

**Library** User-Defined Functions

**Description** The Fcn block applies the specified mathematical expression to its input. The expression can be made up of one or more of these components:

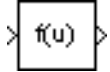

- $u$  — The input to the block. If  $u$  is a vector,  $u(i)$  represents the  $i$ th element of the vector;  $u(1)$  or  $u$  alone represents the first element.
- Numeric constants
- Arithmetic operators (+ - \* /^)
- Relational operators (== != > < >= <=) — The expression returns 1 if the relation is true; otherwise, it returns 0.
- Logical operators (&& || !) — The expression returns 1 if the relation is true; otherwise, it returns 0.
- Parentheses
- Mathematical functions — `abs`, `acos`, `asin`, `atan`, `atan2`, `ceil`, `cos`, `cosh`, `exp`, `fabs`, `floor`, `hypot`, `ln`, `log`, `log10`, `pow`, `power`, `rem`, `sgn`, `sin`, `sinh`, `sqrt`, `tan`, and `tanh`.
- Workspace variables — Variable names that are not recognized in the preceding list of items are passed to MATLAB for evaluation. Matrix or vector elements must be specifically referenced (e.g., `A(1,1)` instead of `A` for the first element in the matrix).

The Fcn block observes the following rules of operator precedence:

- 1 ( )
- 2 ^
- 3 + - (unary)
- 4 !



**5** \* /

**6** + -

**7** > < <= >=

**8** == !=

**9** &&

**10** ||

The expression differs from a MATLAB expression in that the expression cannot perform matrix computations. Also, this block does not support the colon operator (:).

Block input can be a scalar or vector. The output is always a scalar. For vector output, consider using the Math Function block. If a block input is a vector and the function operates on input elements individually (for example, the sin function), the block operates on only the first vector element.

## Data Type Support

The Fcn block accepts and outputs signals of type single or double.

## Parameters and Dialog Box

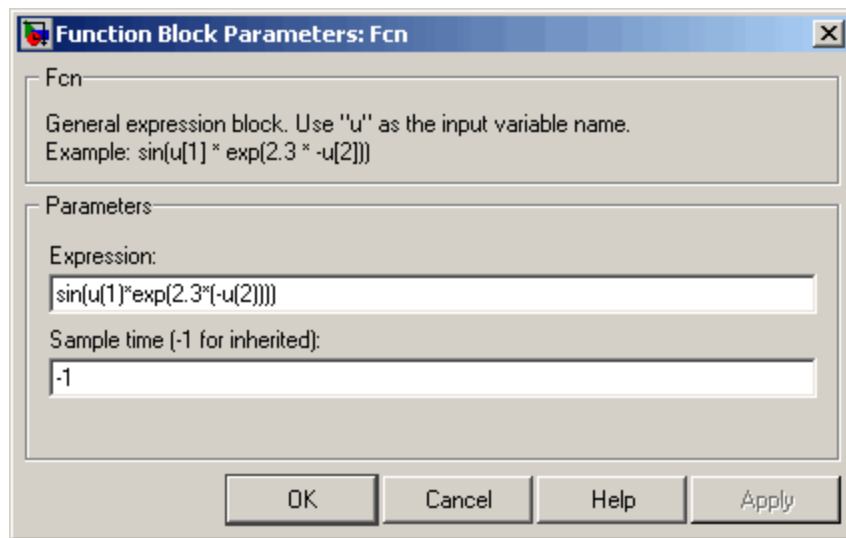

### Expression

The mathematical expression applied to the input. Expression components are listed above. The expression must be mathematically well formed (i.e., matched parentheses, proper number of function arguments, etc.).

---

**Note** You cannot tune the expression during accelerated-mode simulation (see “Accelerating Simulink Models”), in referenced models executing in Accelerator mode (see “Referencing a Model”, or in generated code.

The Fcn block does not support custom storage classes. See “Custom Storage Classes”.

---

**Sample time (-1 for inherited)**

Specify the time interval between samples. To inherit the sample time, set this parameter to -1. See “Specifying Sample Time” in the online documentation for more information.

**Characteristics**

Direct Feedthrough	Yes
Sample Time	Inherited from driving block
Scalar Expansion	No
Dimensionalized	No
Zero Crossing	No

# First-Order Hold

---

**Purpose** Implement first-order sample-and-hold

**Library** Discrete

**Description**



The First-Order Hold block implements a first-order sample-and-hold that operates at the specified sampling interval. This block has little value in practical applications and is included primarily for academic purposes.

This figure compares the output from a Sine Wave block and a First-Order Hold block.

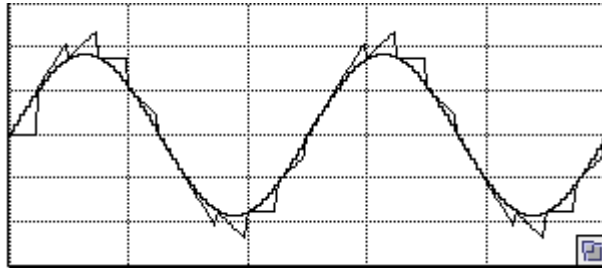

**Data Type Support**

The First-Order Hold block accepts and outputs signals of type double.

## Parameters and Dialog Box

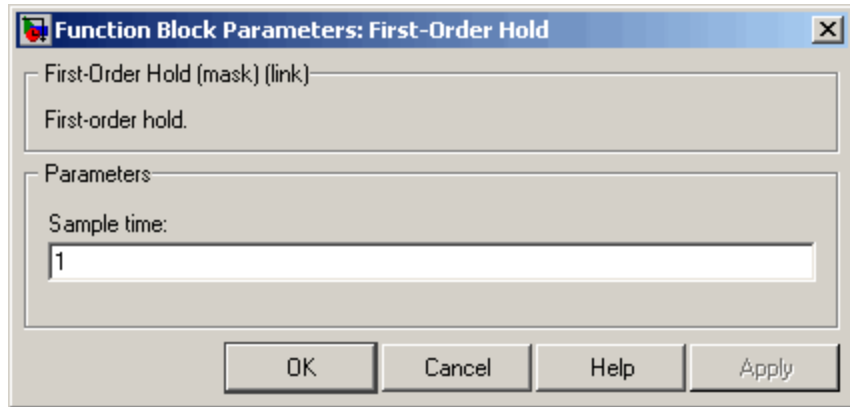

### Sample time

The time interval between samples. See “Specifying Sample Time” in the online documentation for more information.

## Characteristics

Direct Feedthrough	No
Sample Time	Specified in the <b>Sample time</b> parameter
Scalar Expansion	No
States	1 continuous and 1 discrete per input element
Dimensionalized	Yes
Zero Crossing	No

# Fixed-Point State-Space

---

**Purpose** Implement discrete-time state space

**Library** Additional Math & Discrete / Additional Discrete

**Description** The Fixed-Point State-Space block implements the system described by

$$\begin{array}{l} y(n)=Cx(n)+Du(n) \\ x(n+1)=Ax(n)+Bu(n) \end{array}$$

$$y(n) = Cx(n) + Du(n)$$

$$x(n+1) = Ax(n) + Bu(n)$$

where  $u$  is the input,  $x$  is the state, and  $y$  is the output. Both equations have the same data type.

The matrices A, B, C and D have the following characteristics:

- A must be an n-by-n matrix, where n is the number of states.
- B must be an n-by-m matrix, where m is the number of inputs.
- C must be an r-by-n matrix, where r is the number of outputs.
- D must be an r-by-m matrix.

In addition:

- The state  $x$  must be a n-by-1 vector
- The input  $u$  must be a m-by-1 vector
- The output  $y$  must be a r-by-1 vector

The block accepts one input and generates one output. The input vector width is determined by the number of columns in the B and D matrices. The output vector width is determined by the number of rows in the C and D matrices.

## Data Type Support

The Fixed-Point State-Space block accepts signals of any data type supported by Simulink, including fixed-point data types.

## Parameters and Dialog Box

The **Main** pane of the Fixed-Point State-Space block dialog appears as follows:

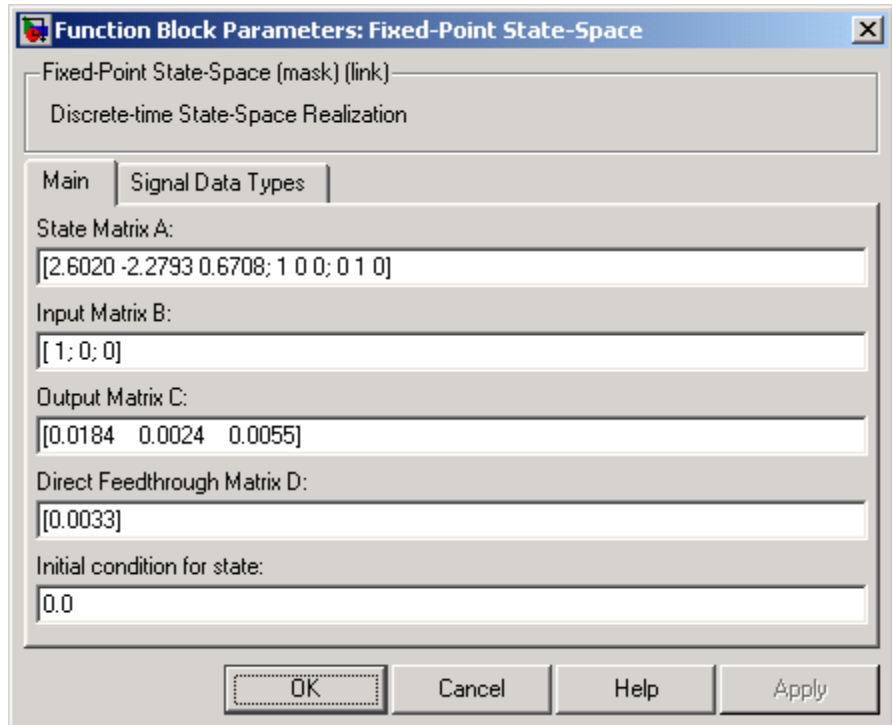

### State Matrix A

Specify the matrix of states.

### Input Matrix B

Specify the column vector of inputs.

### Output Matrix C

Specify the column vector of outputs.

### Direct Feedthrough Matrix D

Specify the matrix for direct feedthrough.

# Fixed-Point State-Space

## Initial condition for state

Specify the initial condition for the state.

The **Signal Data Types** pane of the Fixed-Point State-Space block dialog appears as follows:

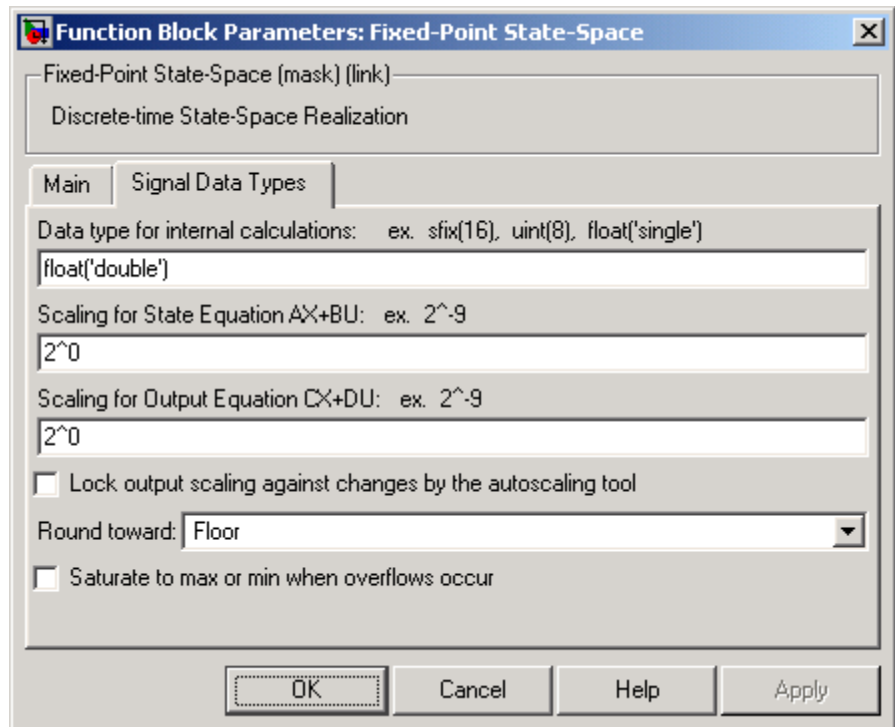

## Data type for internal calculations

Specify the data type for internal calculations.

## Scaling for State Equation AX+BU

Specify the scaling for state equations.

## Scaling for Output Equation CX+DU

Specify the scaling for output equations.



**Lock output scaling against changes by the autoscaling tool**

If you select this check box, the output scaling is locked.

**Round toward**

Select the rounding mode for fixed-point operations.

**Saturate to max or min when overflows occur**

If selected, fixed-point overflows saturate.

**Characteristics**

Direct Feedthrough	Yes
Scalar Expansion	Yes, of initial conditions

# For Iterator

---

## Purpose

Repeatedly execute contents of subsystem at current time step until iteration variable exceeds specified iteration limit

## Library

Ports & Subsystems/For Iterator Subsystem

## Description

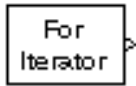

The For Iterator block, when placed in a subsystem, repeatedly executes the contents of the subsystem at the current time step until an iteration variable exceeds a specified iteration limit. You can use this block to implement the block diagram equivalent of a for loop in the C programming language.

The output of a For Iterator subsystem can not be a function-call signal. Simulink will display an error message if the simulation is run or the diagram updated.

The block's parameter dialog allows you to specify the maximum value of the iteration variable or an external source for the maximum value and an optional external source for the next value of the iteration variable. If you do not specify an external source for the next value of the iteration variable, the next value is determined by incrementing the current value:

$$i_{n+1} = i_n + 1$$

The model in the following figure uses a For Iterator block to increment an initial value of zero by 10 over 20 iterations at every time step.

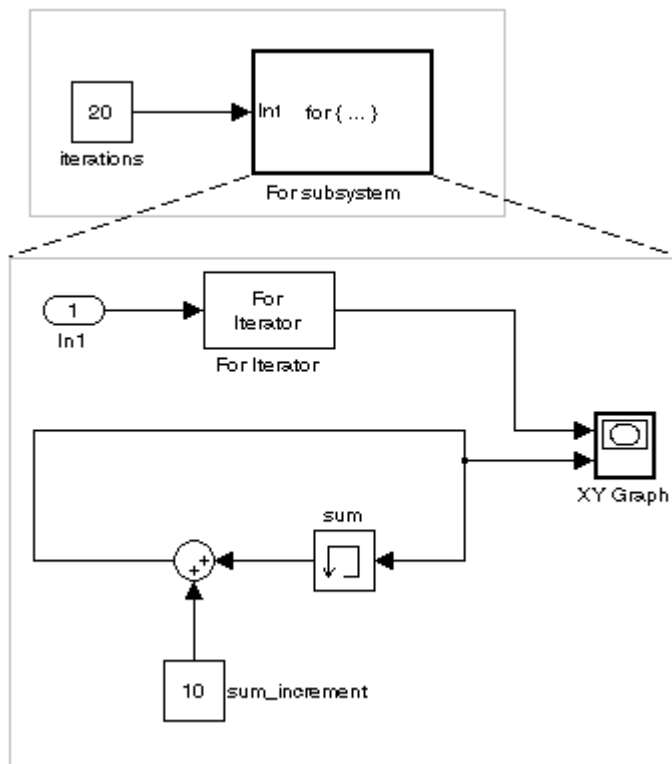

The following figure shows the result.

# For Iterator

---

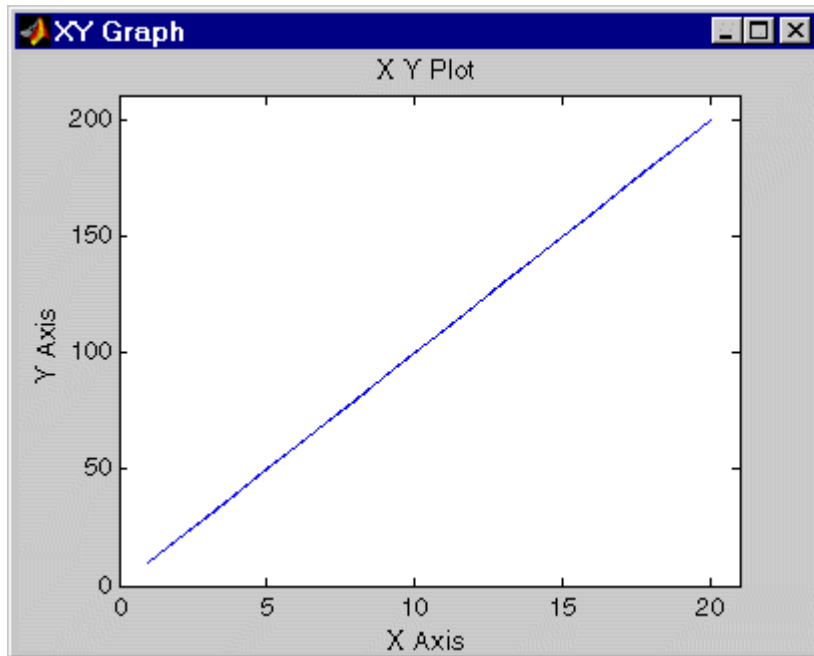

**Points:**  
**(1,10)**  
**(2,20)**  
**etc.**

The For Iterator subsystem in this example is equivalent to the following C code.

```
sum = 0;
iterations = 20;
sum_increment = 10;
for (i = 0; i < iterations; i++) {
    sum = sum + sum_increment;
}
```

---

**Note** Placing a For Iterator block in a subsystem makes it an atomic subsystem if it is not already an atomic subsystem.

---

## Data Type Support

The following rules apply to the data type of the number of iterations (N) input port:

- The input port accepts data of mixed types.
- If the input port value is noninteger, it is first truncated to an integer.
- Internally, the input value is cast to an integer of the type specified for the iteration variable output port.
- If no output port is specified, the input port value is cast to type `int32`.
- If the input port value exceeds the maximum value of the output port's type, it is truncated to that maximum value.

Data output for the iterator value can be selected as `double`, `int32`, `int16`, or `int8` in the Block Properties dialog.

The following rules apply to the iteration variable input port.

- It can appear only if the iteration variable output port is enabled.
- The data type of the iteration variable input port is the same as the data type of the iteration variable output port.

# For Iterator

## Parameters and Dialog Box

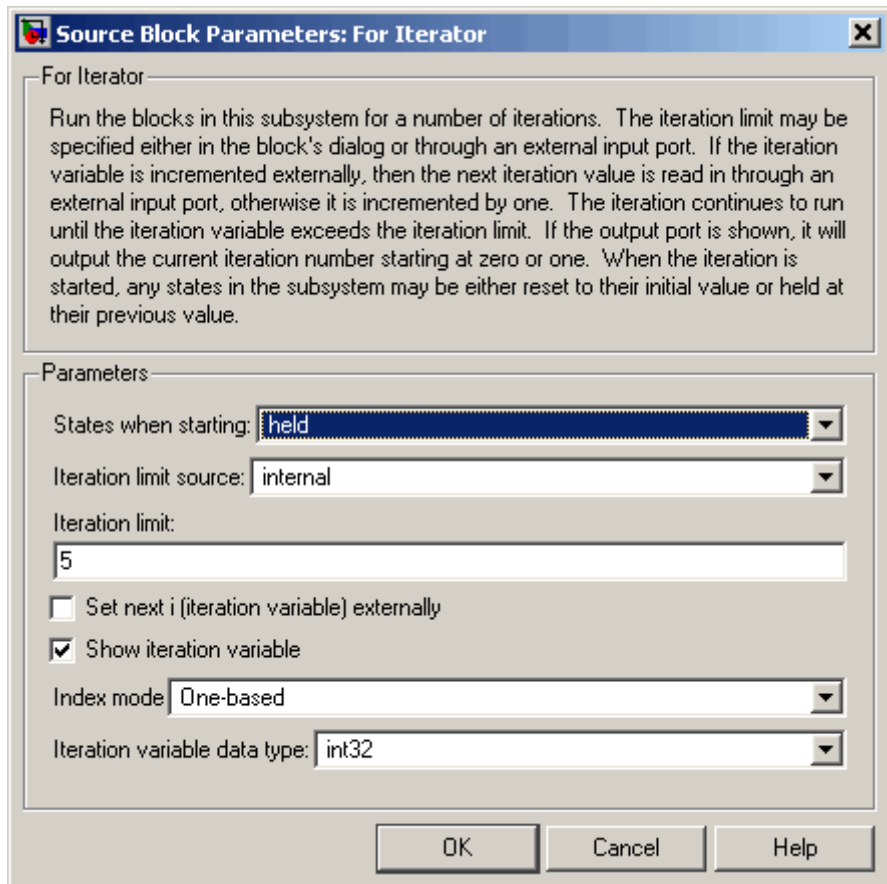

### States when starting

Set this field to reset if you want the states of the For subsystem to be reinitialized before the first iteration at each time step. Otherwise, set this field to `held` (the default) to make sure that these subsystem states retain their values from the last iteration at the previous time step.

## Iteration limit source

If you set this field to `internal`, the value of the **Number of iterations** field determines the number of iterations. If you set this field to `external`, the signal at the For Iterator block's N port determines the number of iterations. The iteration limit source must reside outside the For Iterator subsystem.

## Iteration limit

Set the number of iterations for the For Iterator block to this value. This field appears only if you selected `internal` for the **Source of number of iterations** field.

## Set next i (iteration variable) externally

This option can be selected only if you select the **Show iteration variable** option. If you select this option, the For Iterator block displays an additional input for connecting an external iteration variable source. The value of the input at the current iteration is used as the value of the iteration variable at the next iteration.

## Show iteration variable

If you select this check box, the For Iterator block outputs its iteration value.

## Index mode

If you set this field to `Zero-based`, the iteration number starts at zero. If you set this field to `One-based`, the iteration number starts at one.

## Iteration variable data type

Set the type for the iteration value output from the iteration number port to `double`, `int32`, `int16`, or `int8`.

## Characteristics

Direct Feedthrough	No
Sample Time	Inherited from driving blocks
Scalar Expansion	No

## For Iterator

---

Dimensionalized	No
Zero Crossing	No



**Purpose** Represent subsystem that executes repeatedly during simulation time step

**Library** Ports & Subsystems

**Description**

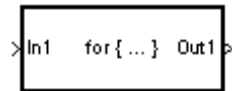

The For Iterator Subsystem block is a Subsystem block that is preconfigured to serve as a starting point for creating a subsystem that executes repeatedly during a simulation time step. For more information, see the For Iterator block in the online Simulink block reference and “Modeling Control Flow Logic” in the Using Simulink documentation.

# From

---

**Purpose** Accept input from Goto block

**Library** Signal Routing

**Description** The From block accepts a signal from a corresponding Goto block, then passes it as output. The data type of the output is the same as that of the input from the Goto block. From and Goto blocks allow you to pass a signal from one block to another without actually connecting them. To associate a Goto block with a From block, enter the Goto block's tag in the **Goto Tag** parameter.

A From block can receive its signal from only one Goto block, although a Goto block can pass its signal to more than one From block.

This figure shows that using a Goto block and a From block is equivalent to connecting the blocks to which those blocks are connected. In the model at the left, Block1 passes a signal to Block2. That model is equivalent to the model at the right, which connects Block1 to the Goto block, passes that signal to the From block, then on to Block2.

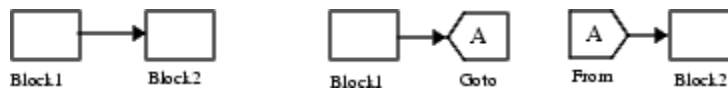

The visibility of a Goto block tag determines the From blocks that can receive its signal. For more information, see [Goto and Goto Tag Visibility](#). The block indicates the visibility of the Goto block tag:

- A local tag name is enclosed in brackets ([]).
- A scoped tag name is enclosed in braces ({}).
- A global tag name appears without additional characters.

## Data Type Support

The From block outputs real or complex signals of any data type supported by Simulink, including fixed-point data types.

For a discussion on the data types supported by Simulink, see “Data Types Supported by Simulink” in the Simulink documentation.

## Parameters and Dialog Box

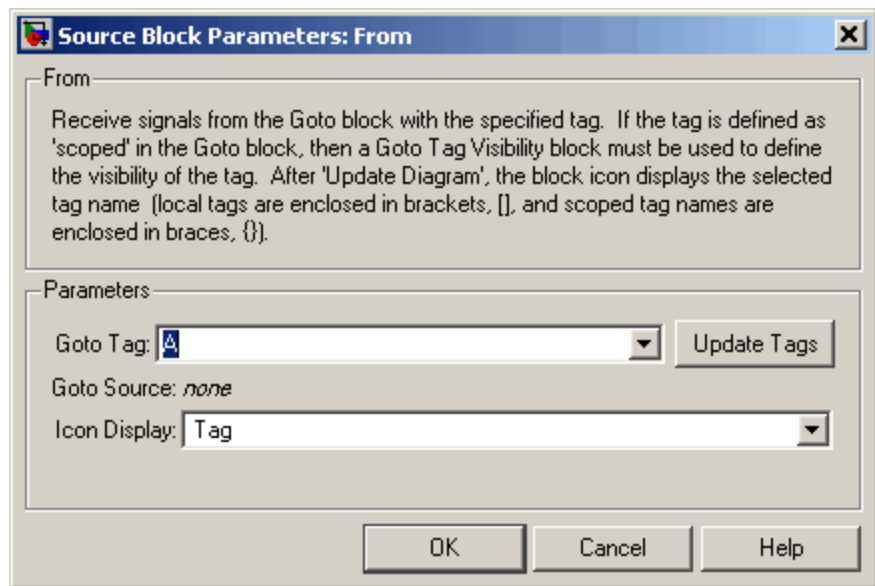

### Goto Tag

The tag of the Goto block that forwards its signal to this From block. To change the tag, select a new tag from this control's drop-down list. The drop-down list displays the Goto tags that the From block can currently see. An item labeled <More Tags...> appears at the end of the list the first time you display the list in a Simulink session. Selecting this item causes the block to update the tags list to include the tags of Goto blocks residing in library subsystems referenced by the model containing this From block. Simulink displays a progress bar while building the list of library tags. Simulink saves the updated tags list for the duration of the Simulink session or until the next time you select the adjacent **Update Tags** button. You need to update the tags list again in the current session only if the libraries referenced by the model have changed since the last time you updated the list.

# From

---

## **Update Tags**

Updates the list of tags visible to this From block, including tags residing in libraries referenced by the model containing this From block.

## **Goto Source**

Path of the Goto block connected to this From block. Clicking the path displays and highlights the Goto block.

## **Icon Display**

Specifies the text to display on the From block's icon. The options are the block's tag, the name of the signal that the block represents, or both the tag and the signal name.

## **Characteristics**

Sample Time	Inherited from block driving the Goto block
Dimensionalized	Yes
Multidimensionalized	Yes

**Purpose** Read data from MAT file

**Library** Sources

**Description**

untitled.mat

The From File block outputs data read from a MAT file. Its icon displays the pathname of the file supplying the data.

---

**Note** The From block can read data only from MAT files. It does not support any other file format.

---

The MAT file must contain a matrix of two or more rows. The first row must contain monotonically increasing time points. Other rows contain data points that correspond to the time point in that column. The matrix is expected to have this form.

$$\begin{bmatrix} t_1 & t_2 & \dots & t_{final} \\ u1_1 & u1_2 & \dots & u1_{final} \\ \dots & & & \\ un_1 & un_2 & \dots & un_{final} \end{bmatrix}$$

The width of the output depends on the number of rows in the MAT file. The block uses the time data to determine its output, but does not output the time values. This means that in a matrix containing  $m$  rows, the block outputs a vector of length  $m-1$ , consisting of data from all but the first row of the appropriate column.

If an output value is needed at a time that falls between two values in the MAT file, the value is linearly interpolated between the appropriate values. If the required time is less than the first time value or greater than the last time value in the MAT file, Simulink extrapolates, using the first two or last two points to compute a value.

If the matrix includes two or more columns at the same time value, the output is the data point for the first column encountered. For example, for a matrix that has this data:

```
time values:    0 1 2 2
data points:   2 3 4 5
```

At time 2, the output is 4, the data point for the first column encountered at that time value.

Simulink reads the MAT file into memory at the start of the simulation. As a result, you cannot read data from the same MAT file named in a To File block in the same model.

See “Importing Data from the MATLAB Workspace” for guidelines on choosing time vectors for discrete systems.

## Using Data Saved by a To File or a To Workspace Block

The From File block can read data written by a To File block without any modifications.

To read data written by a To Workspace block and saved to a MAT file:

- The data must include the simulation times. The easiest way to include time data in the simulation output is to specify a variable for time on the **Data Import/Export** pane of the **Configuration Parameters** dialog box. See “Data Import/Export Pane” for more information.
- Before saving the data from the To Workspace block, transpose it to the form expected by the From File block.

## Data Type Support

The From File block outputs real signals of type double.

## Parameters and Dialog Box

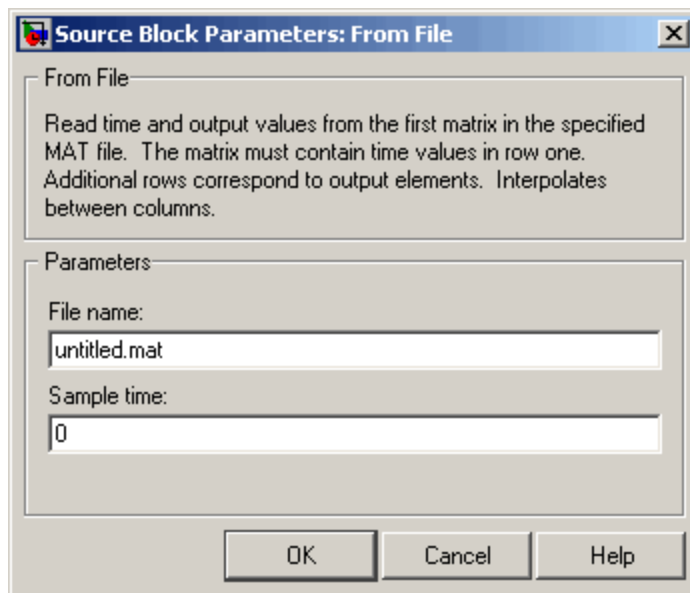

Opening this dialog box causes a running simulation to pause. See “Changing Source Block Parameters During Simulation” in the online Simulink documentation for details.

### File name

The fully qualified pathname or file name of the MAT file that contains the data used as input. On UNIX, the pathname can start with a tilde (~) character signifying your home directory. The default file name is `untitled.mat`. If you specify an unqualified file name, Simulink assumes that the MAT file resides in the MATLAB working directory. (To determine the working directory, enter `pwd` at the MATLAB command line.) If Simulink cannot find the specified file name in the working directory, it displays an error message.

# From File

---

## Sample time

The sample period and offset of the data read from the file. See “Specifying Sample Time” in the online documentation for more information.

## Characteristics

Sample Time	Specified in the <b>Sample time</b> parameter
Scalar Expansion	No
Dimensionalized	1-D array only
Zero Crossing	No



**Purpose** Read data from workspace

**Library** Sources

## Description

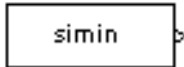

The From Workspace block reads data from the MATLAB workspace. The block's **Data** parameter specifies the workspace data via a MATLAB expression that evaluates to a matrix (2-D array), a structure containing an array of signal values and time steps, or a time series object (see `Simulink.Timeseries`). The format of the matrix or structure is the same as that used to load root-level input port data from the workspace (see “Importing Data from the MATLAB Workspace”). The From Workspace icon displays the expression in the **Data** parameter.

---

**Note** You must use the structure-with-time format or a time series object to load matrix (2-D) data from the workspace.

---

The From Workspace block's **Interpolate data** parameter determines the block's output in the time interval for which workspace data is supplied. If you select the **Interpolate data** option, the block uses linear Lagrangian interpolation to compute data values for time steps that occur between time steps for which the workspace supplies data. In particular, the block linearly interpolates a missing data point from the two known data points between which it falls. For example, suppose the block reads the following time series from the workspace.

```
time:      1   2   3   4
signal:   253 254 ?  256
```

In this case, the block would output:

```
time:      1   2   3   4
signal:   253 254 255 256
```

If you do not select the **Interpolate data** option, the block uses the most recent data value supplied from the workspace.

# From Workspace

---

---

**Note** The data type of the workspace data can affect interpolated values. See “How Data Types Affect Interpolation” on page 2-302 for more information.

---

The block’s **Form output after final data value by** parameter determines the block’s output after the last time step for which data is available from the workspace. The following table summarizes the output block based on the options that the parameter provides.

<b>Form Output Option</b>	<b>Interpolate Option</b>	<b>Block Output After Final Data</b>
Extrapolate	On	Extrapolated from final data value
Extrapolate	Off	Error
SettingToZero	On	Zero
SettingToZero	Off	Zero
HoldingFinalValue	On	Final value from workspace
HoldingFinalValue	Off	Final value from workspace
CyclicRepetition	On	Error
CyclicRepetition	Off	Repeated from workspace. This option is valid only for workspace data in structure-without-time format.

If the input array contains more than one entry for the same time step, Simulink detects a zero crossing at this time step. For example, suppose the input array has this data:

```
time:      0 1 2 2 3
signal:    2 3 4 5 6
```

At time 2, there is a zero crossing from input signal discontinuity.

If the interpolation option is on, the block uses the last two known data points to extrapolates data points that occur after the last known point. Consider the following example.

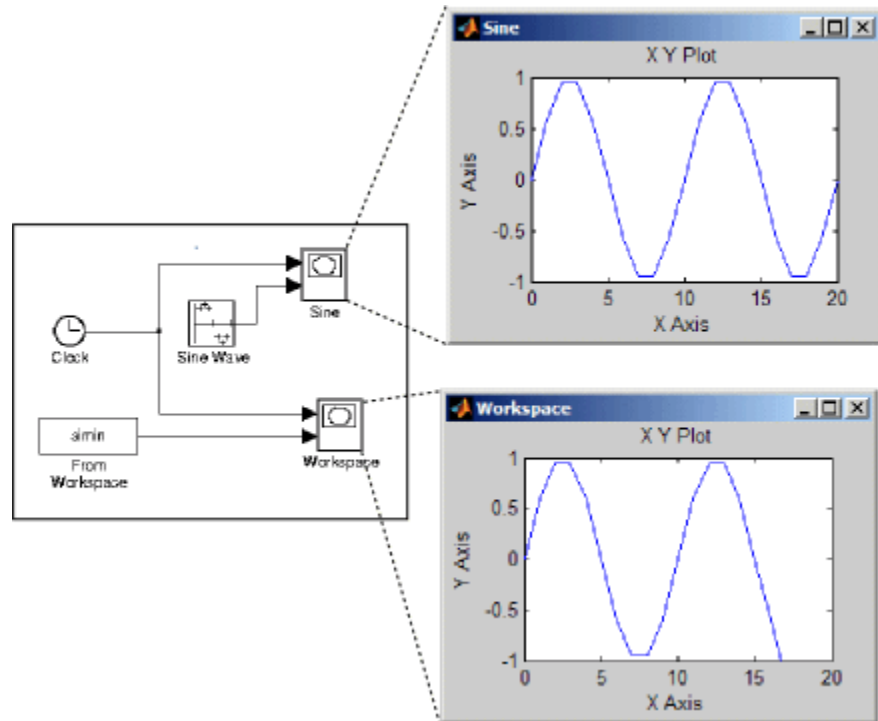

In this example, the From Workspace block reads data from the workspace consisting of the output of the Simulink Sine block sampled at one-second intervals. The workspace contains the first 16 samples of the output. The top and bottom X-Y plots display the output of the Sine Wave and From Workspace blocks, respectively, from 0 to 20 seconds. The straight line in the output of the From Workspace block reflects the block's linear extrapolation of missing data points at the end of the simulation.

# From Workspace

---

---

**Note** A From Workspace block can directly read the output of a To Workspace block (see To Workspace) if the output is in structure-with-time format (see “Importing Data from the MATLAB Workspace” for a description of these formats).

---

See Importing Data from the MATLAB Workspace for guidelines on choosing time vectors for discrete systems.

## Data Type Support

The From Workspace block accepts from the workspace and outputs real or complex signals of any type supported by Simulink. Real signals of type `double` can be in either structure or matrix format. Complex signals and real signals of any type other than `double` must be in structure format.

### How Data Types Affect Interpolation

The data type of the data supplied by the workspace can affect interpolation and extrapolation of missing values in the following cases.

#### Integer data

If the input data type is an integer type and an interpolated data point exceeds the data type’s range, the block sets the missing data point to be the maximum value that the data type can represent. Similarly, if the interpolated or extrapolated value is less than the minimum value that the data type can represent, the block sets the missing data point to the minimum value that the data type can represent. For example, suppose that the data type is `uint8` and the value interpolated for a missing data point is 256.

```
time:      1   2   3   4
signal:    253 254 255 ?
```

In this case, the block sets the value of the missing point to 255, the largest value that can be represented by the `uint8` data type:

```
time:      1   2   3   4
```

```
signal: 253 254 255 255
```

## Boolean data

If the input data is boolean, the block uses the value of the nearest workspace data point as the value of missing data point when determining missing data points that fall between the first and last known points. For example, suppose the workspace supplies values at time steps 1 and 4 but not at 2 and 3:

```
time:    1 2 3 4
signal:  1 ? ? 0
```

In this case, the block would use the value of data point 1 as the value of data point 2 and the value of data point 4 as the value of data point 3:

```
time:    1 2 3 4
signal:  1 1 0 0
```

The block uses the value of the last known data point as the value of time steps that occur after the last known data point.

# From Workspace

## Parameters and Dialog Box

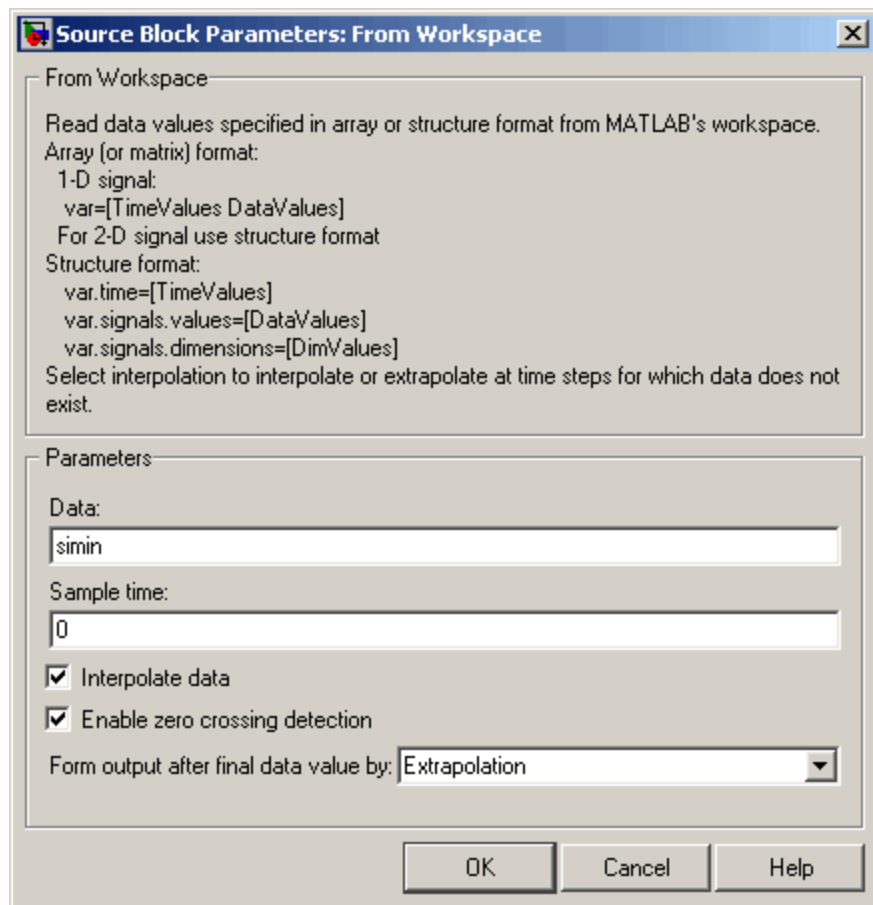

### Data

An expression that evaluates to an array or a structure containing an array of simulation times and corresponding signal values. For example, suppose that the workspace contains a column vector of times named  $T$  and a vector of corresponding signal values named  $U$ . Entering the expression  $[T,U]$  for this parameter yields the required input array. If the required signal-versus-time array or

structure already exists in the workspace, enter the name of the structure or matrix in this field.

### Sample time

Sample rate of data from the workspace. See “Specifying Sample Time” in the online documentation for more information.

### Interpolate data

This option causes the block to linearly interpolate at time steps for which no corresponding workspace data exists. Otherwise, the current output equals the output at the most recent time for which data exists.

### Enable zero crossing detection

Select to enable zero crossing detection. For more information, see “Zero-Crossing Detection” in the “How Simulink Works” chapter of the Using Simulink documentation.

### Form output after final data value by

Select method for generating output after the last time point for which data is available from the workspace.

## Characteristics

Sample Time	Specified in the <b>Sample time</b> parameter
Scalar Expansion	No
Dimensionalized	Yes
Multidimensionalized	Yes
Zero Crossing	Yes

# Function-Call Generator

---

**Purpose** Execute function-call subsystem specified number of times at specified rate

**Library** Ports & Subsystems

## Description

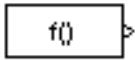

The Function-Call Generator block executes a function-call subsystem (for example, a Stateflow<sup>®</sup> state chart configured as a function-call system) at the rate specified by the block's **Sample time** parameter. To execute multiple function-call subsystems in a prescribed order, first connect a Function-Call Generator block to a Demux block that has as many output ports as there are function-call subsystems to be controlled. Then connect the output ports of the Demux block to the systems to be controlled. The system connected to the first demux port executes first, the system connected to the second demux port executes second, and so on.

## Data Type Support

The Function-Call Generator block outputs a signal of type `fcn_call`.



## Parameters and Dialog Box

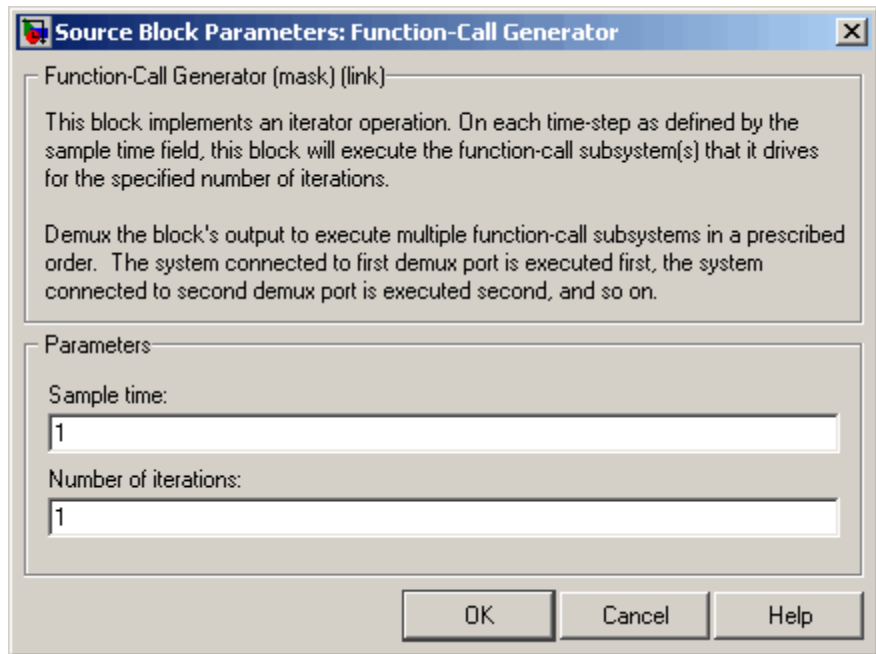

### Sample time

The time interval between samples. See “Specifying Sample Time” in the online documentation for more information.

### Number of iterations

Number of times to execute the block per time step. The value of this parameter may be a vector where each element of the vector specifies a number of times to execute a function-call subsystem. The total number of times that a function-call subsystem executes per time step equals the sum of the values of the elements of the generator signal entering its control port. For example, suppose you specify the number of iterations to be [2 2] and connect the output of this block to the control port of a function-call subsystem. In this case, the function-call subsystem executes four times at each time step.

# Function-Call Generator

---

<b>Characteristics</b>	Direct Feedthrough	No
	Sample Time	Specified in the <b>Sample time</b> parameter
	Scalar Expansion	No
	Dimensionalized	Yes
	Zero Crossing	No

**Purpose** Represent subsystem that can be invoked as function by another block

**Library** Ports & Subsystems

**Description** The Function-Call Subsystem block is a Subsystem block that is preconfigured to serve as a starting point for creating a function-call subsystem. For more information, see “Function-Call Subsystems” in the “Creating a Model” chapter of the Using Simulink documentation.



# Gain

---

**Purpose** Multiply input by constant

**Library** Math Operations

**Description** The Gain block multiplies the input by a constant value (gain). The input and the gain can each be a scalar, vector, or matrix.

You specify the value of the gain in the **Gain** parameter. The **Multiplication** parameter lets you specify element-wise or matrix multiplication. For matrix multiplication, this parameter also lets you indicate the order of the multiplicands.

The gain is converted from doubles to the data specified in the block mask offline using round-to-nearest and saturation. The input and gain are then multiplied, and the result is converted to the output data type using the specified rounding and overflow modes.

**Data Type Support** The Gain block accepts a real or complex scalar, vector, or matrix of any data type supported by Simulink. The Gain block supports fixed-point data types. If the input of the Gain block is real and the gain is complex, the output is complex.

For a discussion on the data types supported by Simulink, see “Data Types Supported by Simulink” in the Simulink documentation.

## Parameters and Dialog Box

The **Main** pane of the Gain block dialog appears as follows:

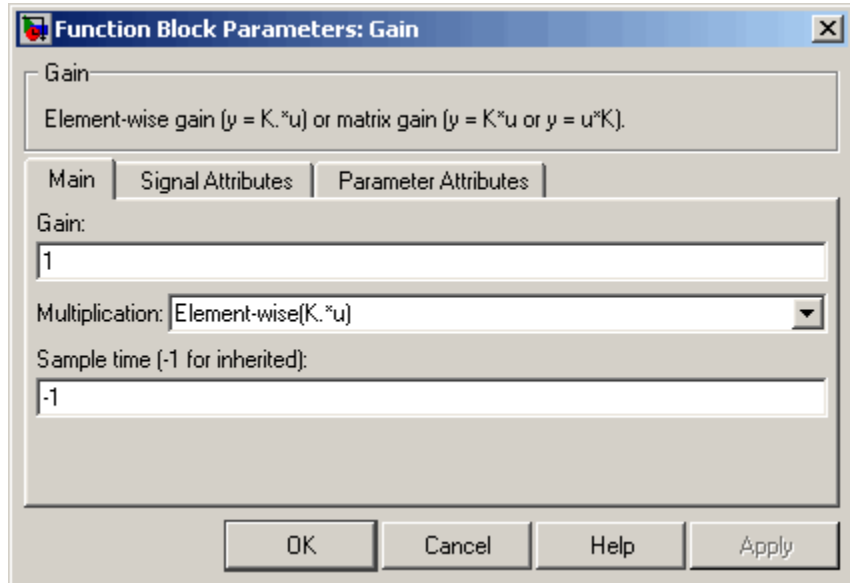

### Gain

Specify the value by which to multiply the input. The gain may be a scalar, vector, or matrix. The gain may not be Boolean.

### Multiplication

Specify the multiplication mode:

- **Element-wise ( $K.*u$ )** — Each element of the input is multiplied by each element of the gain. The block performs expansions, if necessary, so that the input and gain have the same dimensions.
- **Matrix ( $K*u$ )** — The input and gain are matrix multiplied with the input as the second operand.
- **Matrix ( $u*K$ )** — The input and gain are matrix multiplied with the input as the first operand.

# Gain

- **Matrix( $K*u$ ) ( $u$  vector)** — The input and gain are matrix multiplied with the input as the second operand. The input and the output are required to be vectors and their lengths are determined by the dimensions of the gain.

## Sample time (-1 for inherited):

Specify the time interval between samples. To inherit the sample time, set this parameter to -1. See “Specifying Sample Time” in the online documentation for more information.

The **Signal Attributes** pane of the Gain block dialog appears as follows:

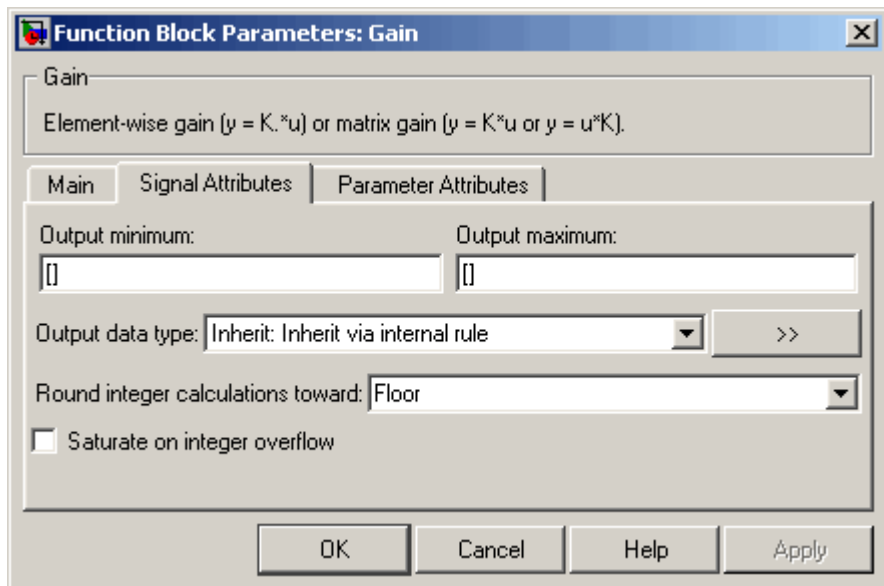

## Output minimum

Specify the minimum value that the block should output. The default value, [], is equivalent to -Inf. Simulink uses this value to perform:

- Simulation range checking (see “Checking Signal Ranges”)

- Automatic scaling of fixed-point data types

### Output maximum

Specify the maximum value that the block should output. The default value, [], is equivalent to Inf. Simulink uses this value to perform:

- Simulation range checking (see “Checking Signal Ranges”)
- Automatic scaling of fixed-point data types

### Output data type

Specify the output data type. You can set it to:

- A rule that inherits a data type, for example, Inherit: Inherit via back propagation
- The name of a built-in data type, for example, single
- The name of a data type object, for example, a Simulink.NumericType object
- An expression that evaluates to a data type, for example, float('single')

Click the **Show data type assistant** button  to display the **Data Type Assistant**, which helps you set the **Output data type** parameter.

See “Specifying Block Output Data Types” in *Using Simulink* for more information.

If you select Inherit: Inherit via internal rule for this parameter, Simulink chooses a combination of output scaling and data type that requires the smallest amount of memory consistent with accommodating the output range and maintaining the output precision of the block and with the word size of the targeted hardware implementation specified for the model. If the **Device type** parameter on the **Hardware Implementation** configuration parameters pane is set to ASIC/FPGA, Simulink

chooses the output data type without regard to hardware constraints. Otherwise, Simulink chooses the smallest available hardware data type capable of meeting the range and precision constraints. For example, if the block multiplies an input of type `int8` by a gain of `int16` and ASIC/FPGA is specified as the targeted hardware type, the output data type is `sfix24`. If Unspecified (assume 32-bit Generic), i.e., a generic 32-bit microprocessor, is specified as the target hardware, the output data type is `int32`. If none of the word lengths provided by the target microprocessor can accommodate the output range, Simulink displays an error message in the Simulation Diagnostics Viewer.

**Lock output scaling against changes by the autoscaling tool**

Select to lock scaling of outputs. This parameter is visible only if you enter an expression for the **Output data type** parameter.

**Round integer calculations toward**

Select the rounding mode for fixed-point operations.

**Saturate on integer overflow**

Select to have overflows saturate.

The **Parameter Attributes** pane of the Gain block dialog appears as follows:



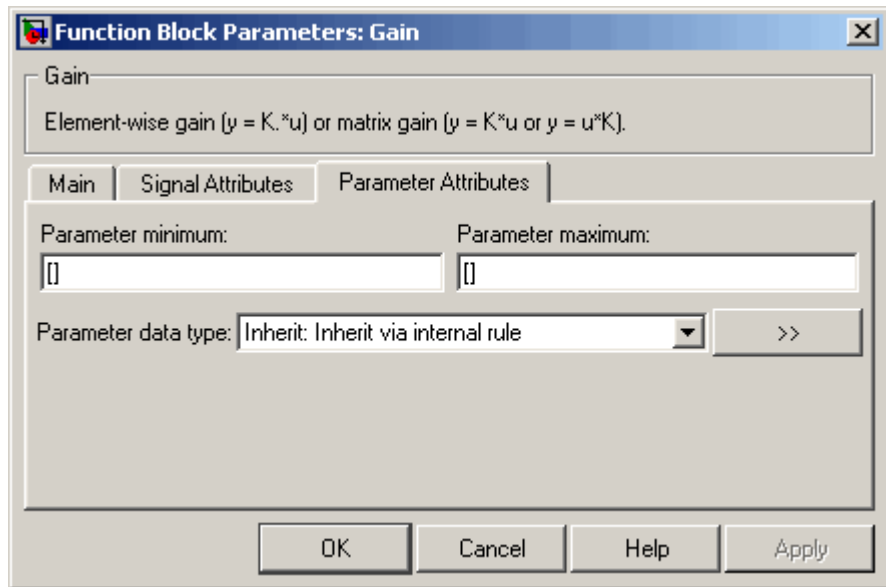

### Parameter minimum

Specify the minimum value of the gain. The default value, [], is equivalent to  $-\text{Inf}$ . Simulink uses this value to perform:

- Parameter range checking (see “Checking Parameter Values”)
- Automatic scaling of fixed-point data types

### Parameter maximum

Specify the maximum value of the gain. The default value, [], is equivalent to  $\text{Inf}$ . Simulink uses this value to perform:

- Parameter range checking (see “Checking Parameter Values”)
- Automatic scaling of fixed-point data types

### Parameter data type

Specify the data type of the **Gain** parameter. You can set it to:

- A rule that inherits a data type, for example, `Inherit: Same as input`

# Gain

---

- The name of a built-in data type, for example, `single`
- The name of a data type object, for example, a `Simulink.NumericType` object
- An expression that evaluates to a data type, for example, `float('single')`

Click the **Show data type assistant** button  to display the **Data Type Assistant**, which helps you set the **Parameter data type** parameter. (See “Using the Data Type Assistant” in *Using Simulink*.)

## Characteristics

Direct Feedthrough	Yes
Sample Time	Specified in the <b>Sample time</b> parameter
Scalar Expansion	Yes, of input and <b>Gain</b> parameter for Element-wise ( $K.*u$ ) multiplication
Dimensionalized	Yes
Multidimensionalized	Yes, only if the <b>Multiplication</b> parameter specifies Element-wise ( $K.*u$ )
Zero Crossing	No

**Purpose** Pass block input to From blocks

**Library** Signal Routing

## Description



The Goto block passes its input to its corresponding From blocks. The input can be a real- or complex-valued signal or vector of any data type. From and Goto blocks allow you to pass a signal from one block to another without actually connecting them.

A Goto block can pass its input signal to more than one From block, although a From block can receive a signal from only one Goto block. The input to that Goto block is passed to the From blocks associated with it as though the blocks were physically connected. Goto blocks and From blocks are matched by the use of Goto tags, defined in the **Tag** parameter.

The **Tag Visibility** parameter determines whether the location of From blocks that access the signal is limited:

- `local`, the default, means that From and Goto blocks using the same tag must be in the same subsystem. A local tag name is enclosed in brackets (`[]`).
- `scoped` means that From and Goto blocks using the same tag must be in the same subsystem or at any level in the model hierarchy below the Goto Tag Visibility block that does not entail crossing a nonvirtual subsystem boundary, i.e., the boundary of an atomic, conditionally executed, or function-call subsystem or a model reference. A scoped tag name is enclosed in braces (`{}`).
- `global` means that From and Goto blocks using the same tag can be anywhere in the model except in locations that span nonvirtual subsystem boundaries.

The rule that From-Goto block connections cannot cross nonvirtual subsystem boundaries has the following exception. A Goto block connected to a state port in one conditionally executed subsystem is visible to a From block inside another conditionally executed subsystem. For more information about conditionally executed subsystems, see

“Creating Conditionally Executed Subsystems” in the “Creating a Model” chapter of the Using Simulink documentation.

---

**Note** A scoped Goto block in a masked system is visible only in that subsystem and in the nonvirtual subsystems it contains. Simulink generates an error if you run or update a diagram that has a Goto Tag Visibility block at a higher level in the block diagram than the corresponding scoped Goto block in the masked subsystem.

---

Use local tags when the Goto and From blocks using the same tag name reside in the same subsystem. You must use global or scoped tags when the Goto and From blocks using the same tag name reside in different subsystems. When you define a tag as global, all uses of that tag access the same signal. A tag defined as scoped can be used in more than one place in the model. This example shows a model that uses two scoped tags with the same name (A).

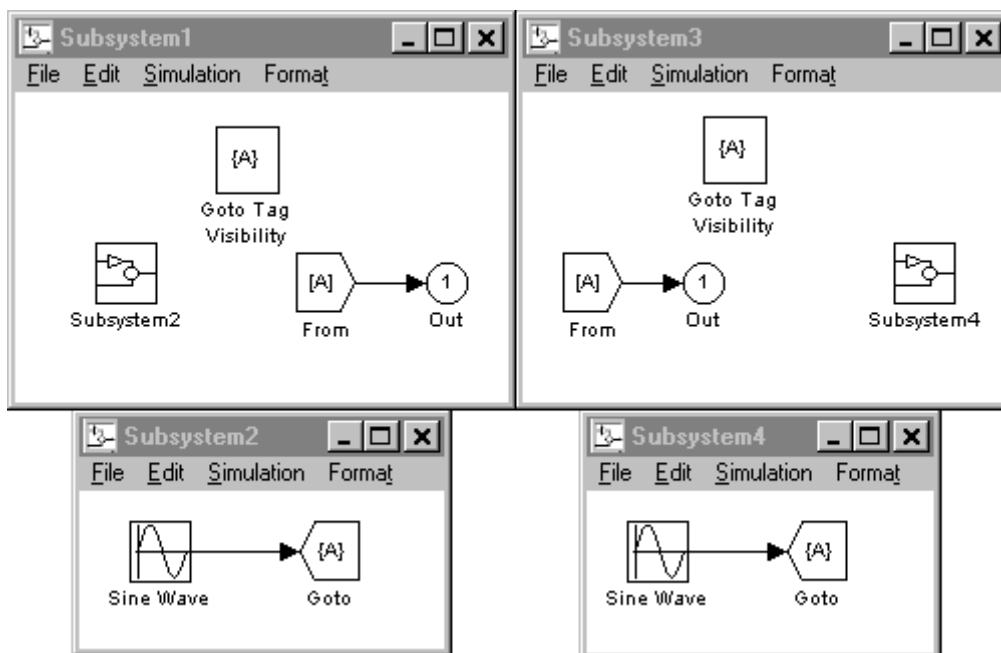

## Data Type Support

The Goto block accepts real or complex signals of any data type supported by Simulink, including fixed-point data types.

For a discussion on the data types supported by Simulink, see “Data Types Supported by Simulink” in the Simulink documentation.

# Goto

## Parameters and Dialog Box

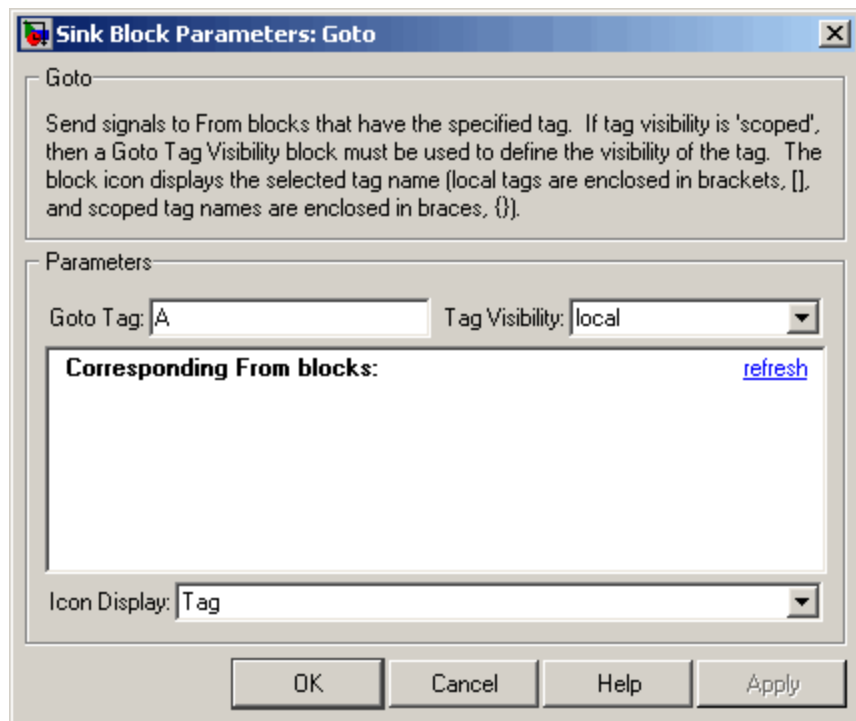

### Tag

The Goto block identifier. This parameter identifies the Goto block whose scope is defined in this block.

### Tag Visibility

The scope of the Goto block tag: local, scoped, or global. The default is local.

### Corresponding From blocks

List of the From blocks connected to this Goto block.

Double-clicking any entry in this list displays and highlights the corresponding From block.

**Icon Display**

Specifies the text to display on the block's icon. The options are the block's tag, the name of the signal that the block represents, or both the tag and the signal name.

**Characteristics**

Sample Time	Inherited from driving block
Dimensionalized	Yes
Multidimensionalized	Yes

# Goto Tag Visibility

**Purpose** Define scope of Goto block tag

**Library** Signal Routing

## Description



The Goto Tag Visibility block defines the accessibility of Goto block tags that have scoped visibility. The tag specified as the **Goto tag** parameter is accessible by From blocks in the same subsystem that contains the Goto Tag Visibility block and in subsystems below it in the model hierarchy.

A Goto Tag Visibility block is required for Goto blocks whose **Tag Visibility** parameter value is scoped. No Goto Tag Visibility block is needed if the tag visibility is either `local` or `global`. The block shows the tag name enclosed in braces (`{}`).

## Data Type Support

Not applicable.

## Parameters and Dialog Box

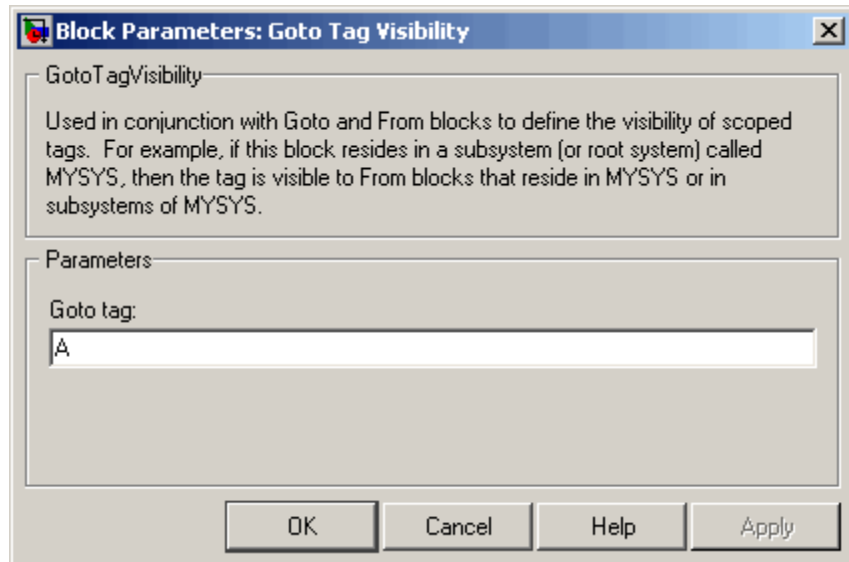



**Goto tag**

The Goto block tag whose visibility is defined by the location of this block.

<b>Characteristics</b>	Sample Time	N/A
	Dimensionalized	N/A

# Ground

---

**Purpose** Ground unconnected input port

**Library** Sources

## Description



The Ground block can be used to connect blocks whose input ports are not connected to other blocks. If you run a simulation with blocks having unconnected input ports, Simulink issues warning messages. Using Ground blocks to ground those blocks avoids warning messages. The Ground block outputs a signal with zero value. The data type of the signal is the same as that of the port to which it is connected.

## Data Type Support

The Ground block outputs a signal of the same numeric type and data type as the port to which it is connected. For example, consider the following model.

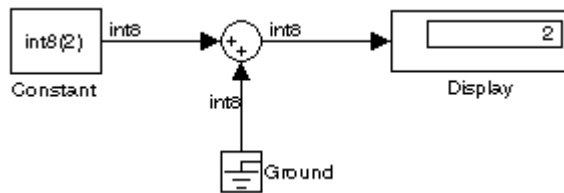

In this example, the output of the Constant block determines the data type (`int8`) of the port to which the Ground block is connected. That port in turn determines the type of the signal output by the Ground block.

The Ground block supports all data types supported by Simulink, including fixed-point data types.

## Parameters and Dialog Box

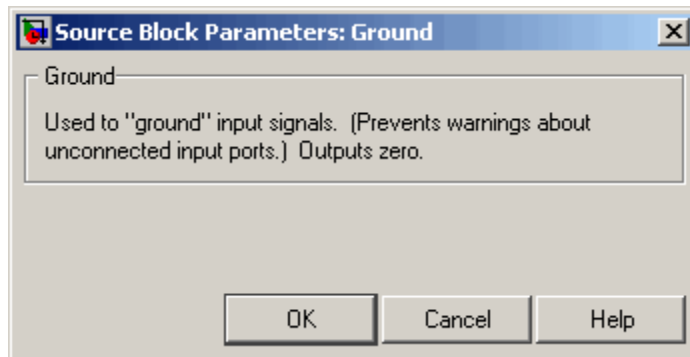

## Characteristics

Sample Time	Inherited from driven block
Dimensionalized	Yes
Multidimensionalized	Yes

# Hit Crossing

---

**Purpose** Detect crossing point

**Library** Discontinuities

**Description**

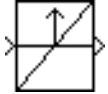

The Hit Crossing block detects when the input reaches the **Hit crossing offset** parameter value in the direction specified by the **Hit crossing direction** property.

The block accepts one input of type double. If you select the **Show output port** check box, the block output indicates when the crossing occurs. If the input signal is exactly the value of the offset value after the hit crossing is detected, the block continues to output a value of 1. If the input signals at two adjacent points bracket the offset value (but neither value is exactly equal to the offset), the block outputs a value of 1 at the second time step. If the **Show output port** check box is *not* selected, the block ensures that the simulation finds the crossing point but does not generate output. If the input signal is constant and equal to the offset value, the block outputs 1 only if the **Hit crossing direction** property is set to either.

When the block's **Hit crossing direction** property is set to either, the block serves as an "Almost Equal" block, useful in working around limitations in finite mathematics and computer precision. Used for these reasons, this block might be more convenient than adding logic to your model to detect this condition.

The `hardstop` and `sldemo_clutch` demos illustrate the use of the Hit Crossing block. In the `hardstop` demo, the Hit Crossing block is in the Friction Model subsystem. In the `sldemo_clutch` demo, the Hit Crossing block is in the Friction Mode Logic/Lockup Detection subsystem.

**Data Type Support**

The Hit Crossing block outputs a signal of type Boolean if Boolean logic signals are enabled (see "Implement logic signals as boolean data (vs. double)"). Otherwise, the block outputs a signal of type double.

## Parameters and Dialog Box

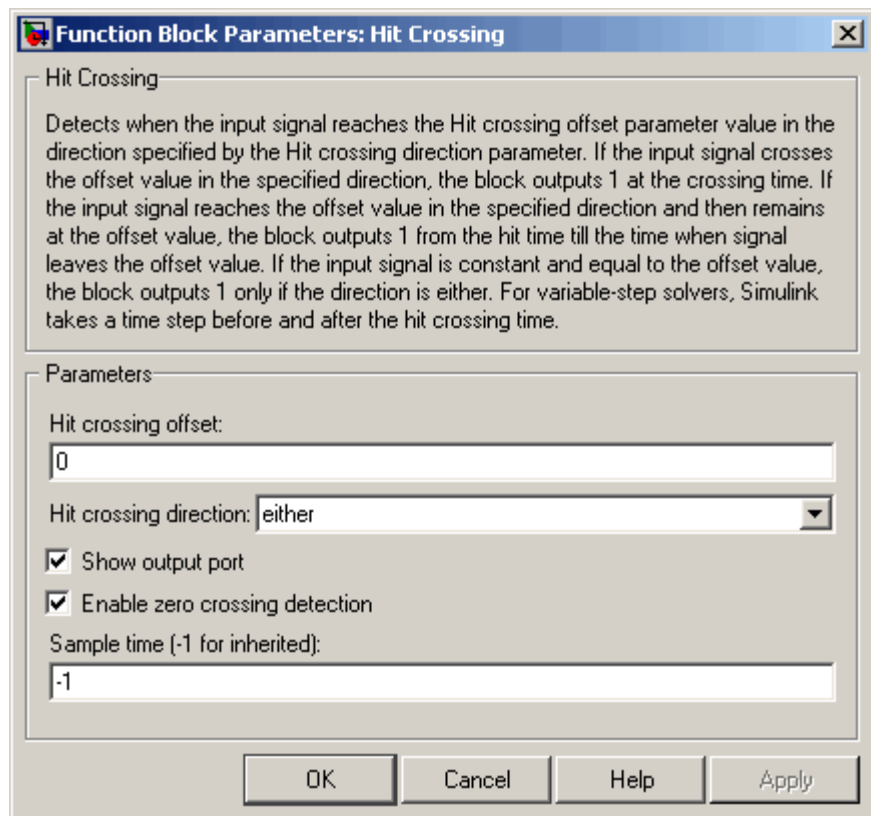

### Hit crossing offset

The value whose crossing is to be detected.

### Hit crossing direction

The direction from which the input signal approaches the hit crossing offset for a crossing to be detected.

### Show output port

If selected, draw an output port.

# Hit Crossing

---

## **Enable zero crossing detection**

Select to enable zero crossing detection. For more information, see “Zero-Crossing Detection” in the “How Simulink Works” chapter of the Using Simulink documentation.

## **Sample time (-1 for inherited)**

Specify the time interval between samples. To inherit the sample time, set this parameter to -1. See “Specifying Sample Time” in the online documentation for more information.

## **Characteristics**

Direct Feedthrough	Yes
Sample Time	Inherited from driving block
Scalar Expansion	Yes
Dimensionalized	Yes
Zero Crossing	Yes, if enabled.

**Purpose**

Set initial value of signal

**Library**

Signal Attributes

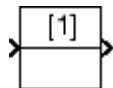
**Description**

The IC block sets the initial condition of the signal at its input port, e.g., the value of the signal at the simulation start time ( $t_{\text{start}}$ ). The block does this by outputting the specified initial condition when you start the simulation, regardless of the actual value of the input signal. Thereafter, the block outputs the actual value of the input signal.

---

**Note** If an IC block inherits or specifies a sample time offset ( $t_{\text{offset}}$ ), the IC block outputs its initial value at time  $t$ , where

$$t = t_{\text{start}} + t_{\text{offset}}$$

That is, the IC block outputs its initial value only after the offset time elapses.

---

The IC block is useful for providing an initial guess for the algebraic state variables in a loop. For more information, see “Algebraic Loops” in the “How Simulink Works” chapter of *Using Simulink*.

**Data Type Support**

The IC block accepts and outputs signals of any Simulink built-in and fixed-point data type. The **Initial value** parameter accepts any built-in data type supported by Simulink.

## Parameters and Dialog Box

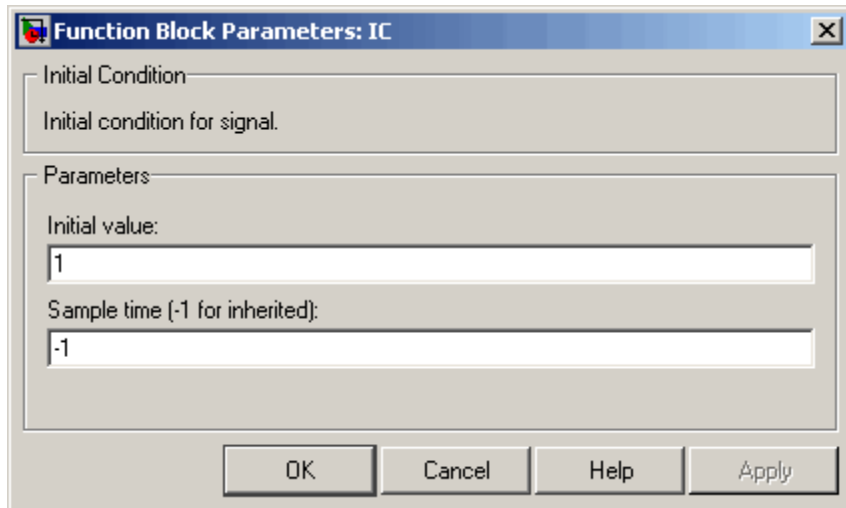

### Initial value

Specify the initial value for the input signal.

### Sample time (-1 for inherited)

Specify the time interval between samples. To inherit the sample time, set this parameter to -1. See “Specifying Sample Time” in the online documentation for more information.

## Examples

The following diagram illustrates how the IC block initializes a signal labeled “test signal.”

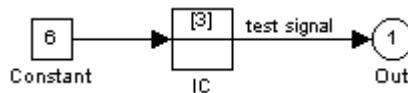

At  $t = 0$ , the signal value is 3. Afterward, the signal value is 6.



---

<b>Characteristics</b>	Direct Feedthrough	Yes
	Sample Time	Specified in the <b>Sample time</b> parameter
	Scalar Expansion	Yes, of parameter only
	Dimensionalized	Yes
	Multidimensionalized	Yes
	Zero Crossing	No

# If

**Purpose** Model if-else control flow

**Library** Ports & Subsystems

**Description** The If block, along with If Action subsystems containing Action Port blocks, implements standard C-like if-else logic.

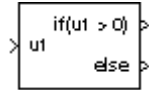

The following shows a completed if-else control flow statement.

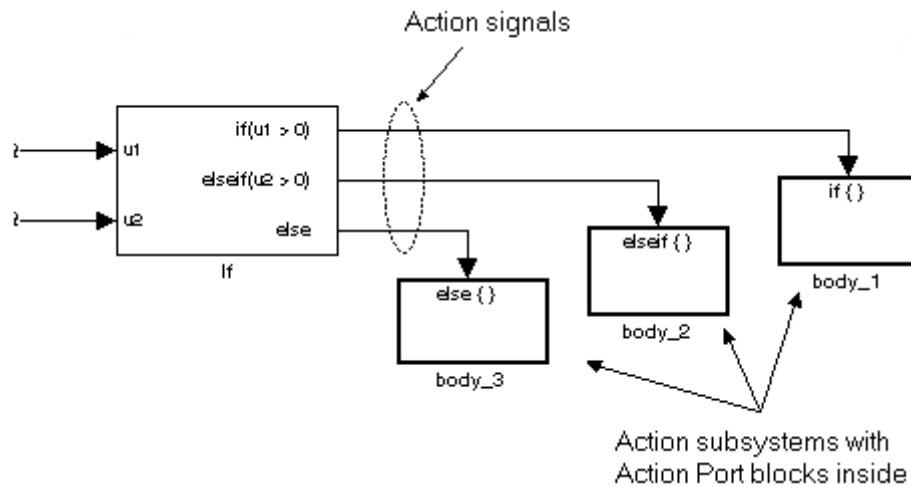

In this example, the inputs to the If block determine the values of conditions represented as output ports. Each output port is attached to an If Action subsystem. The conditions are evaluated top down starting with the if condition. If a condition is true, its If Action subsystem is executed and the If block does not evaluate any remaining conditions.

The preceding if-else control flow statement can be represented by the following pseudocode.

```
if (u1 > 0) {  
    body_1;  
}
```

```
else if (u2 > 0){
    body_2;
}
else {
    body_3;
}
```

You construct a Simulink if-else control flow statement like the preceding example as follows:

**1** Place an If block in the current system.

**2** Open the **Block Parameters** dialog of the If block and enter as follows:

- Enter the **Number of inputs** field with the required number of inputs necessary to define conditions for the if-else control flow statement.

Elements of vector inputs can be accessed for conditions using (row, column) arguments. For example, you can specify the fifth element of the vector u2 in the condition  $u2(5) > 0$  in an **If expression** or **Elseif expressions** field.

- Enter the expression for the if condition of the if-else control flow statement in the **If expression** field.

This creates an if output port for the If block with a label of the form `if(condition)`. This is the only required If Action signal output for an If block.

- Enter expressions for any elseif conditions of the if-else control flow statement in the **Elseif expressions** field.

Use a comma to separate one condition from another. Entering these conditions creates an output port for the If block for each condition, with a label of the form `elseif(condition)`. elseif ports are optional and not required for operation of the If block.

- Check the **Show else condition** check box to create an else output port.

The else port is optional and not required for the operation of the If block.

- 3** Create If Action subsystems to connect to each of the if, else, and elseif ports.

These consist of a subsystem with an Action Port block. When you place an Action Port block inside each subsystem, an input port named Action is added to the subsystem.

- 4** Connect each if, else, and elseif port of the If block to the Action port of an If Action subsystem.

When you make the connection, the icon for the If Action block is renamed to the type of the condition that it attaches to.

---

**Note** During simulation of an if-else control flow statement, the Action signal lines from the If block to the If Action subsystems turn from solid to dashed.

---

- 5** In each If Action subsystem, enter the Simulink blocks appropriate to the body to be executed for the condition it handles.

---

**Note** All blocks in an If Action Subsystem must run at the same rate as the driving If block. You can achieve this by setting each block's sample time parameter to be either inherited (-1) or the same value as the If block's sample time.

---

In the preceding example, the If Action subsystems are named body\_1, body\_2, and body\_3.

---

**Data Type Support**

Inputs  $u_1, u_2, \dots, u_n$  can be scalar or vector of any built-in Simulink data type and must be all of the same data type. For a discussion on the data types supported by Simulink, see “Data Types Supported by Simulink” in the Simulink documentation.

Outputs from the if, else, and elseif ports are Action signals to If Action subsystems that are created with Action Port blocks and subsystems. See Action Port.

## Parameters and Dialog Box

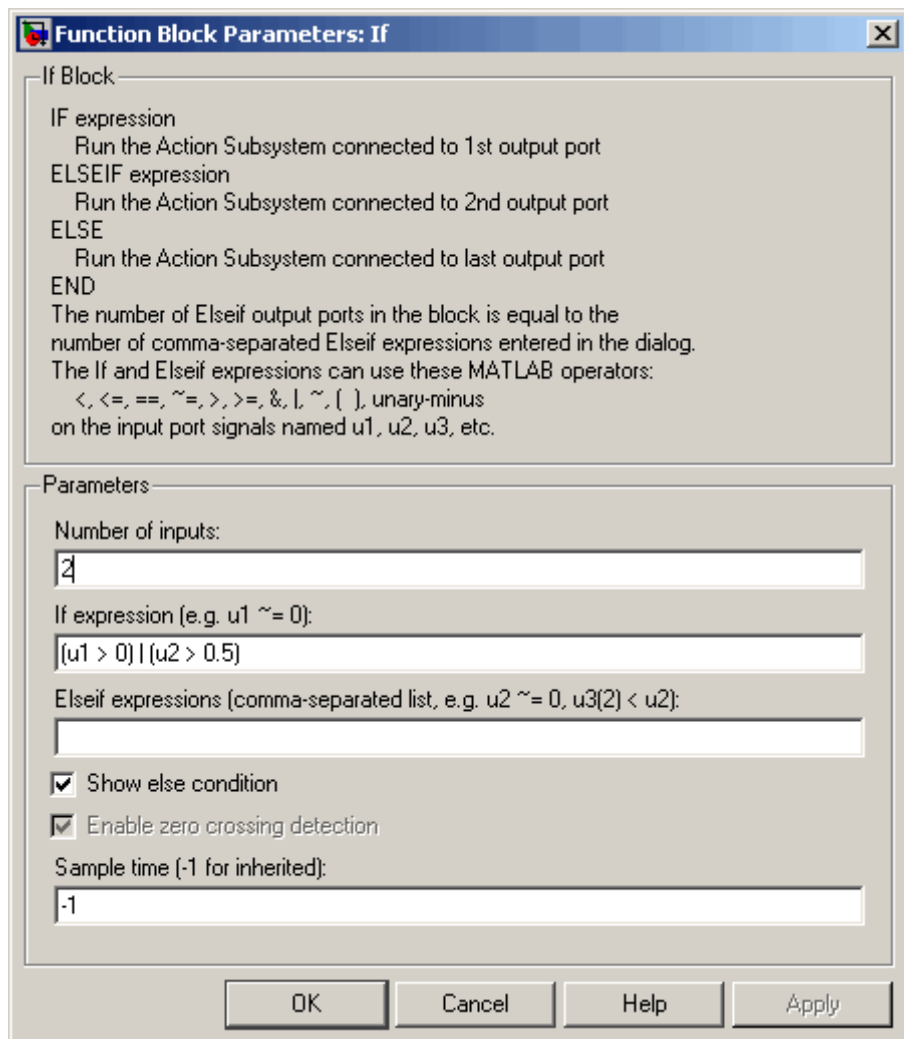

---

### Number of inputs

The number of inputs to the If block. These appear as data input ports labeled with a 'u' character followed by a number, 1, 2, . . . , n, where n equals the number of inputs that you specify.

### If expression

The condition for the if output port. This condition appears on the If block adjacent to the if output port. The if expression can use any of the following operators: <, <=, ==, ~=, >, >=, &, |, ~, (), unary-minus. The If Action subsystem attached to the if port executes if its condition is true. The expression must not contain data type expressions, e.g., int8(6), and must not reference workspace variables whose data type is other than double or single.

---

**Note** You cannot tune the **If expression** during accelerated-mode simulation (see “Accelerating Simulink Models”), in referenced models executing in Accelerator mode, or in code generated from the model. The If block also does not support custom storage classes.

---

### Elseif expressions

A string list of elseif conditions delimited by commas. These conditions appear below the if port and above the else port if you select the **Show else condition** check box. elseif expressions can use any of the following operators: <, <=, ==, ~=, >, >=, &, |, ~, (), unary-minus. The If Action subsystem attached to an elseif port executes if its condition is true and all of the if and elseif conditions are false. The expression must not contain data type expressions, e.g., int8(6), and must not reference workspace variables whose data type is other than double or single.

---

**Note** You cannot tune the **Elseif expression** during accelerated-mode simulation (see “Accelerating Simulink Models”), in referenced models executing in Accelerator mode, or in code generated from the model. The If block also does not support custom storage classes.

---

### **Show else condition**

If you select this check box, an else port is created. The If Action subsystem attached to the else port executes if the if port and all the elseif ports are false.

### **Enable zero crossing detection**

Select to enable zero crossing detection. For more information, see “Zero-Crossing Detection” in the “How Simulink Works” chapter of the Using Simulink documentation.

### **Sample time**

Specify the sample time of the input signal. See “Specifying Sample Time” in the online documentation for more information.

## **Examples**

The If block does not directly support fixed-point data types. However, you can use the Compare To Constant block to work around this limitation.

For example, consider the following floating-point model.



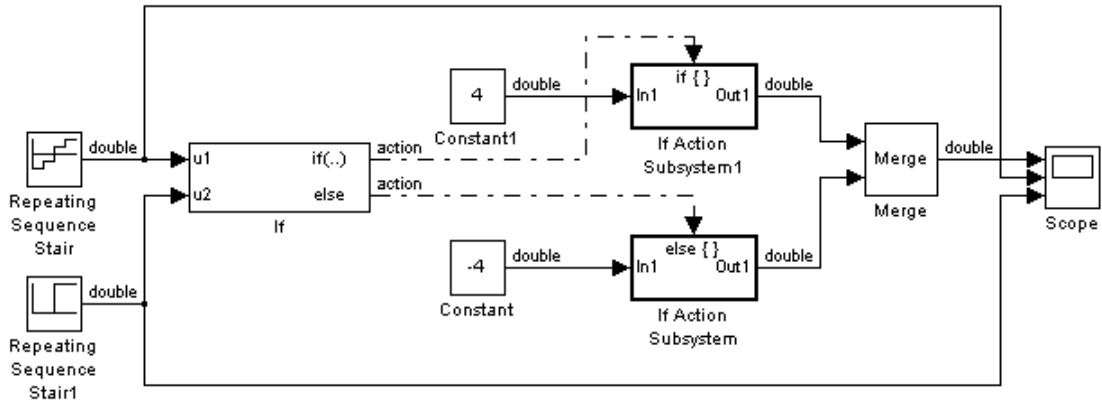

In this model, the If Action subsystems use their default configurations. The block and simulation parameters for the model are set to their default values except as follows:

Block or Dialog	Parameter	Setting
Configuration Parameters Dialog — Solver pane	Start time	0.0
	Stop time	1.0
	Type	Fixed-step
	Solver	discrete (no continuous states)
	Fixed-step size	.1
Repeating Sequence Stair	Vector of output values	[-2 -1 1 2].'
Repeating Sequence Stair1	Vector of output values	[0 0 0 0 1 1 1 1].'
If	Number of inputs	2

# If

---

Block or Dialog	Parameter	Setting
	<b>If expression</b>	(u1 > 0)   (u2 > 0.5)
	<b>Show else condition</b>	selected
Constant	<b>Constant value</b>	-4
Constant1	<b>Constant value</b>	4
Scope	<b>Number of axes</b>	3
	<b>Time range</b>	1

For this model, if input u1 is greater than 0 or input u2 is greater than 0.5, the output is 4. Otherwise, the output is -4. The Scope block shows the output, u1, and u2 as depicted here:

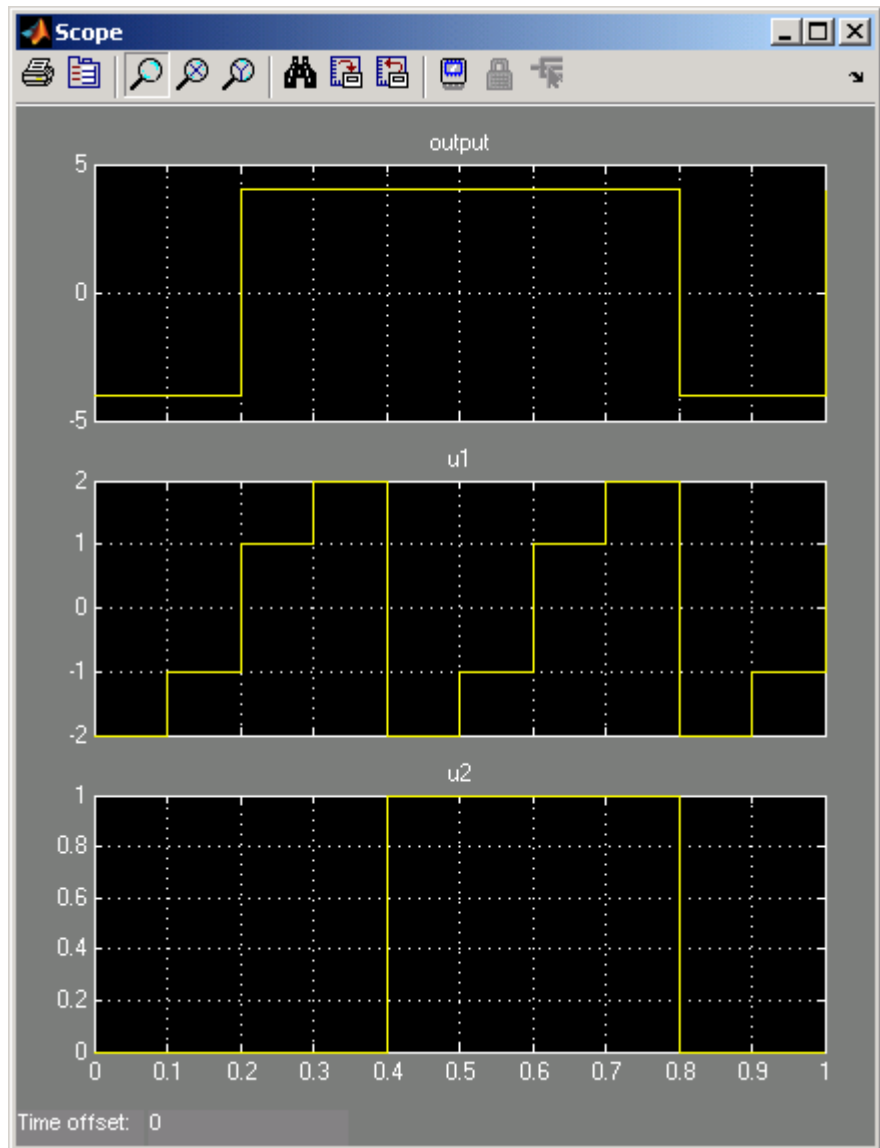

The same model can be implemented using fixed-point data types:

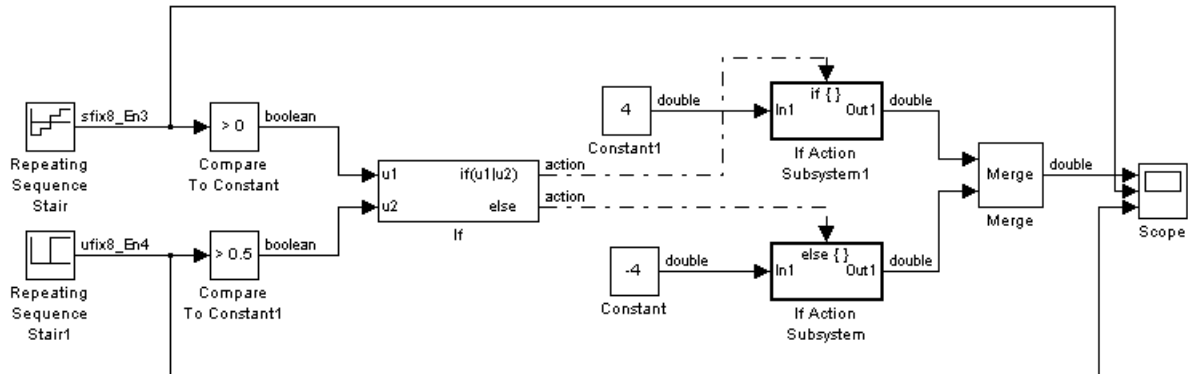

The Repeating Sequence stair blocks are now outputting fixed-point data types.

The Compare To Constant blocks implement two parts of the **If expression** that is used in the If block in the floating-point version of the model,  $(u1 > 0)$  and  $(u2 > 0.5)$ . The OR operation,  $(u1 | u2)$ , can still be implemented inside the If block. For a fixed-point model, the expression must be partially implemented outside of the If block as it is here.

The block and simulation parameters for the fixed-point model are the same as for the floating-point model with the following exceptions and additions:

Block	Parameter	Setting
Compare To Constant	<b>Operator</b>	>
	<b>Constant value</b>	0
	<b>Output data type mode</b>	Boolean

Block	Parameter	Setting
	<b>Enable zero crossing detection</b>	unselected
Compare To Constant1	<b>Operator</b>	>
	<b>Constant value</b>	0.5
	<b>Output data type mode</b>	Boolean
	<b>Enable zero crossing detection</b>	unselected
If	<b>Number of inputs</b>	2
	<b>If expression</b>	u1   u2

### Characteristics

Direct Feedthrough	Yes
Sample Time	Inherited from driving block
Scalar Expansion	No
Dimensionalized	Yes
Zero Crossing	Yes, if enabled

# If Action Subsystem

---

**Purpose** Represent subsystem whose execution is triggered by If block

**Library** Ports & Subsystems

**Description** The If Action Subsystem block is a Subsystem block that is preconfigured to serve as a starting point for creating a subsystem whose execution is triggered by an If block.

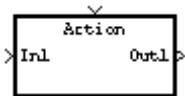

---

**Note** All blocks in an If Action Subsystem must run at the same rate as the driving If block. You can achieve this by setting each block's sample time parameter to be either inherited (-1) or the same value as the If block's sample time.

---

For more information, see the If block and Modeling with Control Flow Blocks in the “Creating a Model” chapter of the Using Simulink documentation.

- Purpose** Increase real world value of signal by one
- Library** Additional Math & Discrete / Additional Math: Increment - Decrement
- Description** The Increment Real World block increases the real world value of the signal by one. Overflows always wrap.
- Data Type Support** The Increment Real World block accepts signals of any data type supported by Simulink, including fixed-point data types.

**Parameters and Dialog Box**

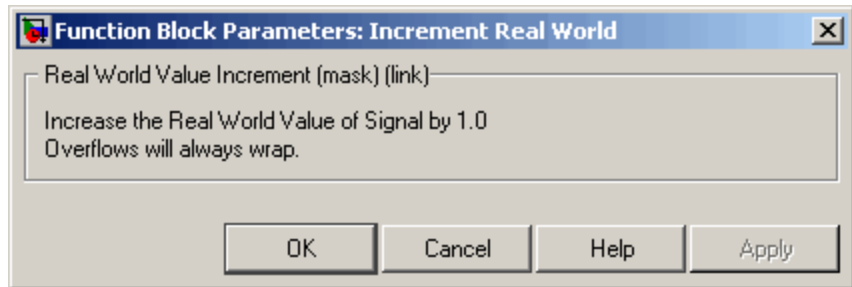

- Characteristics**
- |                    |     |
|--------------------|-----|
| Direct Feedthrough | Yes |
| Scalar Expansion   | No  |

**See Also** Decrement Real World, Increment Stored Integer

# Increment Stored Integer

---

## Purpose

Increase stored integer value of signal by one

## Library

Additional Math & Discrete / Additional Math: Increment - Decrement

## Description

The Increment Stored Integer block increases the stored integer value of a signal by one.

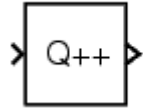

Floating-point signals are also increased by one, and overflows always wrap.

## Data Type Support

The Increment Stored Integer block accepts signals of any data type supported by Simulink, including fixed-point data types.

## Parameters and Dialog Box

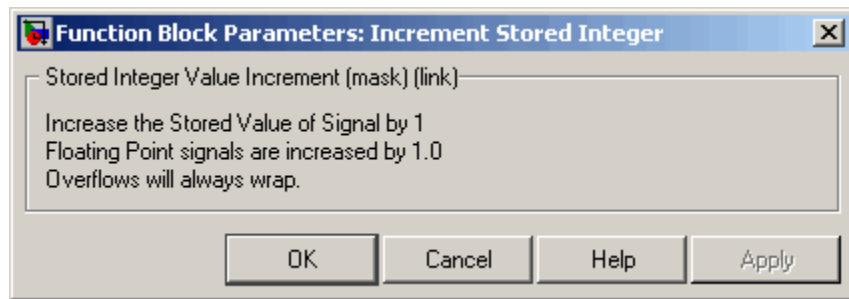

## Characteristics

Direct Feedthrough	Yes
Scalar Expansion	No

## See Also

Decrement Stored Integer, Increment Real World



**Purpose** Switch output between different inputs based on value of first input

**Library** Signal Routing

**Description** The Index Vector block is an implementation of the Multiport Switch block. See Multiport Switch for more information.

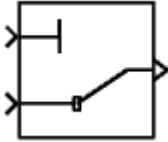

# Inport

---

<b>Purpose</b>	Create input port for subsystem or external input
<b>Library</b>	Ports & Subsystems, Sources
<b>Description</b>	<p>Inport blocks are the links from outside a system into the system. Simulink assigns Inport block port numbers according to these rules:</p> <ul style="list-style-type: none"><li>• It automatically numbers the Inport blocks within a top-level system or subsystem sequentially, starting with 1.</li><li>• If you add an Inport block, it is assigned the next available number.</li><li>• If you delete an Inport block, other port numbers are automatically renumbered to ensure that the Inport blocks are in sequence and that no numbers are omitted.</li><li>• If you copy an Inport block into a system, its port number is <i>not</i> renumbered unless its current number conflicts with an Inport block already in the system. If the copied Inport block port number is not in sequence, you must renumber the block or you will get an error message when you run the simulation or update the block diagram.</li></ul>

You can specify the dimensions of the input to the Inport block using the **Port dimensions** parameter, or let Simulink determine it automatically by providing a value of -1.

The **Sample time** parameter is the rate at which the signal is coming into the system. A value of -1 causes the block to inherit its sample time from the block driving it. You might need to set this parameter for Inport blocks in a top-level system or in models where Inport blocks are driven by blocks whose sample times cannot be determined. See “Specifying Sample Time” in the online documentation for more information.

## Inport Blocks in a Subsystem

Inport blocks in a subsystem represent inputs to the subsystem. A signal arriving at an input port on a Subsystem block flows out of the associated Inport block in that subsystem. The Inport block associated

with an input port on a Subsystem block is the block whose **Port number** parameter matches the relative position of the input port on the Subsystem block. For example, the Inport block whose **Port number** parameter is 1 gets its signal from the block connected to the topmost port on the Subsystem block.

If you renumber the **Port number** of an Inport block, the block becomes connected to a different input port, although the block continues to receive its signal from the same block outside the subsystem.

The Inport block name appears in the Subsystem icon as a port label. To suppress display of the label, select the Inport block and choose **Hide Name** from the **Format** menu.

## Inport Blocks in a Top-Level System

Inport blocks in a top-level system have two uses:

- To supply external inputs from the workspace, use either the **Configuration Parameters** dialog (see “Importing Data from the MATLAB Workspace”) or the `ut` argument of the `sim` command (see `sim`) to specify the inputs.
- To provide a means for perturbation of the model by the `linmod` and `trim` analysis functions, use Inport blocks to define the points where inputs are injected into the system.

## Creating Duplicate Inports

You can create any number of duplicates of an Inport block. The duplicates are graphical representations of the original intended to simplify block diagrams by eliminating unnecessary lines. The duplicate has the same port number, properties, and output as the original. Changing a duplicate’s properties changes the original’s properties and vice versa.

To create a duplicate of an Inport block,

- 1 Select the block.

- 2 Select **Copy** from the Simulink **Edit** menu or from the block's context menu.
- 3 Position the mouse cursor in the model's block diagram where you want to create the duplicate.
- 4 Select **Paste Duplicate Inport** from the Simulink **Edit** menu or the block diagram's context menu.

## Data Type Support

The Inport block accepts complex or real signals of any data type supported by Simulink, including fixed-point data types. For a discussion on the data types supported by Simulink, see “Data Types Supported by Simulink”.

The numeric and data types of the block's output are the same as those of its input. You can specify the signal type, data type, and sampling mode of an external input to a root-level Inport block using the **Signal type**, **Data type**, and **Sampling mode** parameters.

The elements of a signal array connected to a root-level Inport block must be of the same numeric and data types. Signal elements connected to a subsystem input port can be of differing numeric and data types except in the following circumstance: If the subsystem contains an Enable or Trigger block or is an Atomic Subsystem and the input port, or an element of the input port, is connected directly to an output port, the input elements must be of the same type. For example, consider the follow enabled subsystem.

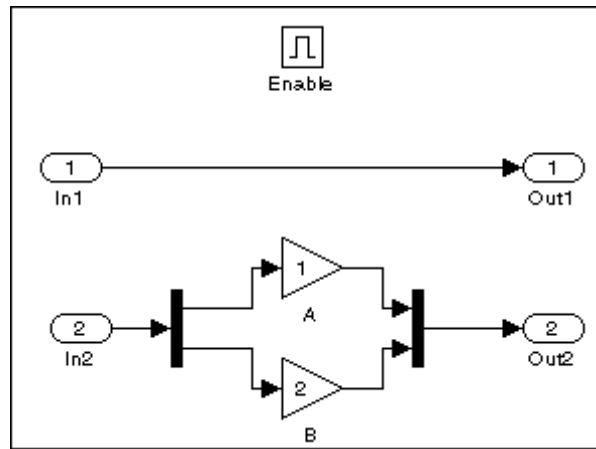

In this example, the elements of a signal vector connected to In1 must be of the same type. The elements connected to In2, however, can be of differing types.

# Inport

## Parameters and Dialog Box

The **Main** pane of the Inport block dialog appears as follows:

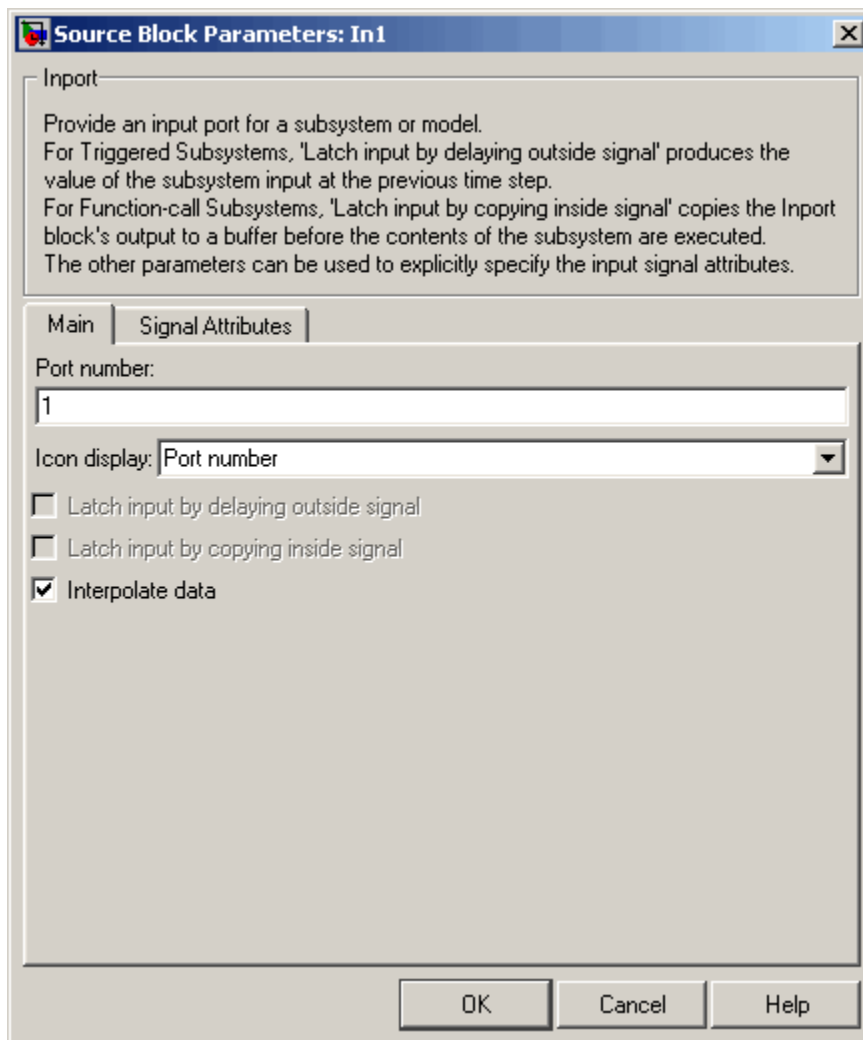

## Port number

Specify the port number of the Inport block.

## Icon display

Specifies the information to be displayed on the icon of this input port. The options are:

Port number	Displays port number of this port.
Signal name	Displays the name of the signal connected to this port (or signals if the input is a bus).
Port name and signal name	Displays both the port number and the names of the signals connected to this port.

## Latch input by delaying outside signal

This option applies only to triggered subsystems and is enabled only if the Inport block resides in a triggered subsystem. If selected, the block outputs the value of the input signal at the previous time step. This enables Simulink to resolve data dependencies among triggered subsystems that are part of a loop. Type `sl_subsys_semantics` at the MATLAB prompt for examples using latched inputs with triggered subsystems.

The Inport block indicates that this option is selected by displaying `<Lo>`.

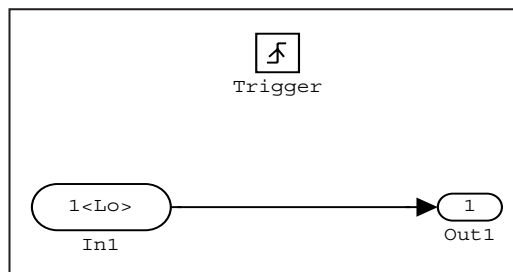

## Latch input by copying inside signal

This option applies only to function-call subsystems and hence is enabled only if the Inport block resides in a function-call subsystem. Selecting this option causes Simulink to copy the signal output by the block into a buffer before executing the contents of the subsystem and to use this copy as the block's output during execution of the subsystem. This ensures that the subsystem's inputs, including those generated by the subsystem's context, will not change during execution of the subsystem. Type `s1_subsys_semantics` at the MATLAB prompt for examples using latched inputs with function-call subsystems.

The Inport block displays `<Li>` to indicate that this option is selected.

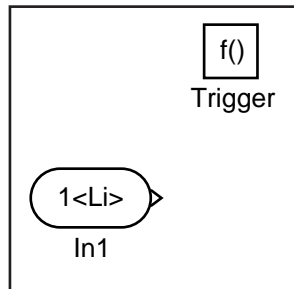

## Interpolate data

Select this parameter to cause the block to interpolate or extrapolate output at time steps for which no corresponding workspace data exists when loading data from the workspace. See “Importing Data from the MATLAB Workspace” for more information.

The **Signal Attributes** pane of the Inport block dialog appears as follows:



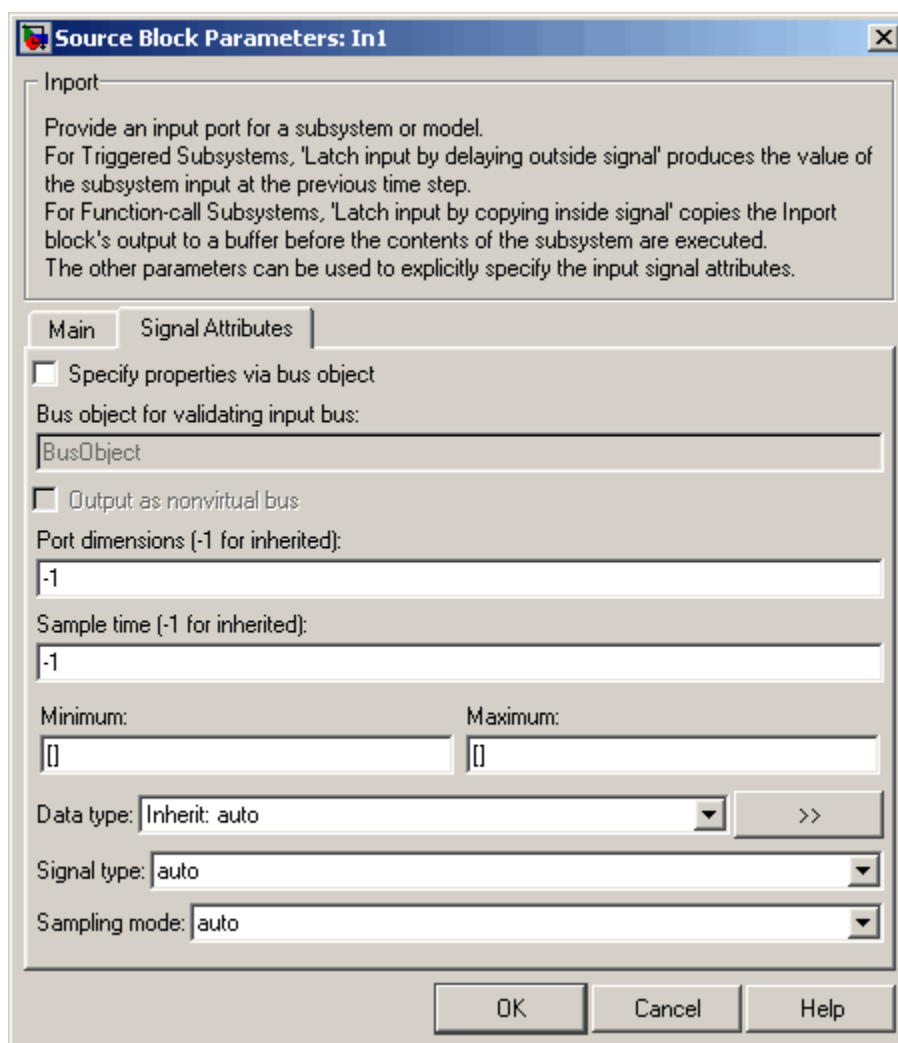

## **Specify properties via bus object**

Select this option to use a bus object to define the structure of the bus created by this block (see “Working with Data Objects” and Simulink.Bus class to learn how to create bus objects).

## **Bus object for validating input bus**

This option is enabled only if you select the **Specify properties via bus object option**. It specifies the name of the bus object that defines the structure that a bus must have to be connected to this input port. At the beginning of a simulation or when you update the model’s diagram, Simulink checks whether the bus connected to this input port has the specified structure. If not, Simulink displays an error message.

## **Output as nonvirtual bus**

This option is enabled only if you select the **Specify properties via bus object option**. If this option is selected, this block outputs a nonvirtual bus; otherwise, it outputs a virtual bus (see “Virtual and Nonvirtual Buses”). Select this option if you want code generated from this model to use a C structure to define the structure of the bus signal output by this block.

## **Port dimensions**

Specify the dimensions of the input signal to the Inport block. Valid values are:

-1	Dimensions are inherited from input signal
n	Vector signal of width n accepted
[m n]	Matrix signal having m rows and n columns accepted

## **Sample time**

Specify the sample time of the input signal. See “Specifying Sample Time”.

**Minimum**

Specify the minimum value that the block should output. The default value, [], is equivalent to  $-\text{Inf}$ . Simulink uses this value to perform:

- Simulation range checking (see “Checking Signal Ranges”)
- Automatic scaling of fixed-point data types

**Maximum**

Specify the maximum value that the block should output. The default value, [], is equivalent to  $\text{Inf}$ . Simulink uses this value to perform:

- Simulation range checking (see “Checking Signal Ranges”)
- Automatic scaling of fixed-point data types

**Data type**

Specify the output data type of the external input. You can set it to:

- A rule that inherits a data type, for example, `Inherit: auto`
- The name of a built-in data type, for example, `single`
- The name of a data type object, for example, a `Simulink.NumericType` object
- An expression that evaluates to a data type, for example, `float('single')`

Click the **Show data type assistant** button  to display the **Data Type Assistant**, which helps you set the **Data type** parameter.

See “Specifying Block Output Data Types” in *Using Simulink* for more information.

**Signal type**

Specify the numeric type (real or complex) of the external input. To accept either type, set this parameter to `auto`.

## Sampling mode

Specify the sampling mode (Sample based or Frame based) that the input signal must match. To accept any sampling mode, set this parameter to auto. This parameter is intended to support signal processing applications based on Simulink. See the documentation for the buffer function provided by Signal Processing Toolbox or “Frame-Based Signals” in the documentation for Signal Processing Blockset for information about frame-based signals.

## Characteristics

Sample Time	Specified in the <b>Sample time</b> parameter
Dimensionalized	Yes
Multidimensionalized	Yes

**Purpose** Delay signal N sample periods

**Library** Discrete

**Description** The Integer Delay block delays its input by N sample periods.

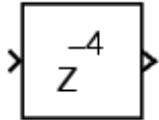

The block accepts one input and generates one output, both of which can be scalar or vector. If the input is a vector, all elements of the vector are delayed by the same sample period.

**Data Type Support** The Integer Delay block accepts signals of any data type supported by Simulink, including fixed-point data types.

## Parameters and Dialog Box

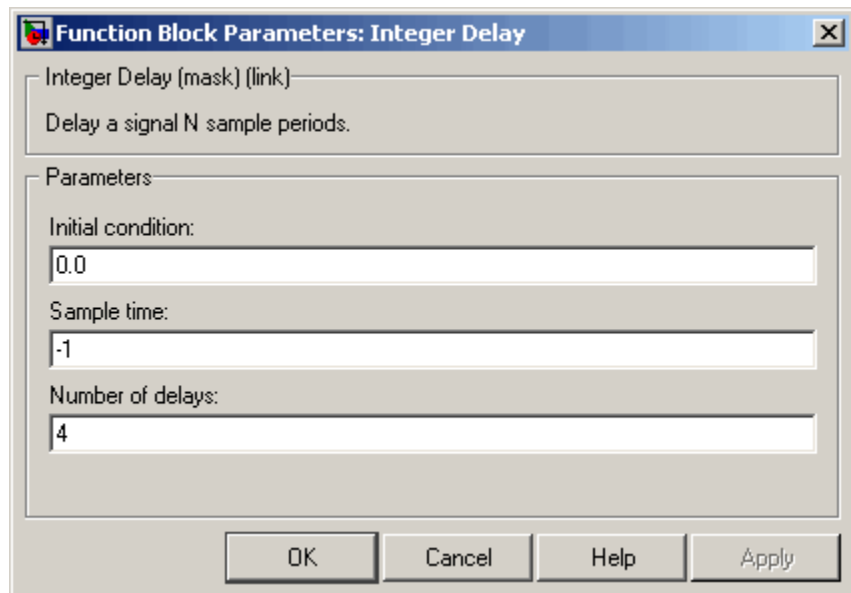

# Integer Delay

---

## **Initial condition**

The initial output of the simulation. The **Initial condition** parameter is converted from a double to the input data type offline using round-to-nearest and saturation.

## **Sample time (-1 for inherited)**

Specify the time interval between samples. To inherit the sample time, set this parameter to -1. See “Specifying Sample Time” in the online documentation for more information.

## **Number of delays**

The number of periods to delay the input signal.

## **Characteristics**

Direct Feedthrough	No
Sample Time	Specified in the <b>Sample time</b> parameter
Scalar Expansion	Yes, of input or initial conditions

**Purpose** Integrate signal

**Library** Continuous

**Description**

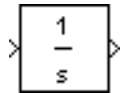

The Integrator block outputs the integral of its input at the current time step. The following equation represents the output of the block  $y$  as a function of its input  $u$  and an initial condition  $y_0$ , where  $y$  and  $u$  are vector functions of the current simulation time  $t$ .

$$y(t) = \int_{t_0}^t u(t)dt + y_0$$

Simulink can use a number of different numerical integration methods to compute the Integrator block's output, each with advantages in particular applications. The **Solver** pane of the **Configuration parameters** dialog box (see "Solver Pane") allows you to select the technique best suited to your application.

Simulink treats the Integrator block as a dynamic system with one state, its output. The Integrator block's input is the state's time derivative.

$$x = y(t)$$

$$x_0 = y_0$$

$$\dot{x} = u(t)$$

The currently selected solver computes the output of the Integrator block at the current time step, using the current input value and the value of the state at the previous time step. To support this computational model, the Integrator block saves its output at the current time step for use by the solver to compute its output at the next time step. The block also provides the solver with an initial condition for use in computing the block's initial state at the beginning of a simulation run. The default value of the initial condition is 0. The block's parameter dialog box allows you to specify another value for the initial condition or create an initial value input port on the block.

The parameter dialog box also allows you to

# Integrator

---

- Define upper and lower limits on the integral
- Create an input that resets the block's output (state) to its initial value, depending on how the input changes
- Create an optional state output that allows you to use the value of the block's output to trigger a block reset

Use the Discrete-Time Integrator block to create a purely discrete system.

## Defining Initial Conditions

You can define the initial conditions as a parameter on the block dialog box or input them from an external signal:

- To define the initial conditions as a block parameter, specify the **Initial condition source** parameter as internal and enter the value in the **Initial condition** parameter field.
- To provide the initial conditions from an external source, specify the **Initial condition source** parameter as external. An additional input port appears under the block input, as shown in this figure.

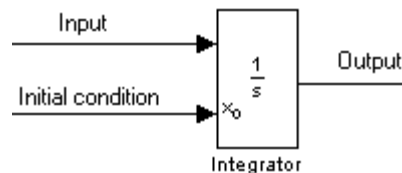

---

**Note** If the integrator limits its output (see **“Limiting the Integral”** on page 2-363), the initial condition must fall inside the integrator's saturation limits. If the initial condition is outside the block's saturation limits, the block displays an error message.

---



## Limiting the Integral

To prevent the output from exceeding specifiable levels, select the **Limit output** check box and enter the limits in the appropriate parameter fields. Doing so causes the block to function as a limited integrator. When the output reaches the limits, the integral action is turned off to prevent integral wind up. During a simulation, you can change the limits but you cannot change whether the output is limited. The output is determined as follows:

- When the integral is less than or equal to the **Lower saturation limit**, the output is held at the **Lower saturation limit**.
- When the integral is between the **Lower saturation limit** and the **Upper saturation limit**, the output is the integral.
- When the integral is greater than or equal to the **Upper saturation limit**, the output is held at the **Upper saturation limit**.

To generate a signal that indicates when the state is being limited, select the **Show saturation port** check box. A saturation port appears below the block output port, as shown on this figure.

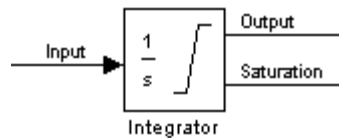

The signal has one of three values:

- 1 indicates that the upper limit is being applied.
- 0 indicates that the integral is not limited.
- -1 indicates that the lower limit is being applied.

When you select this option, the block has three zero crossings: one to detect when it enters the upper saturation limit, one to detect when

it enters the lower saturation limit, and one to detect when it leaves saturation.

## Resetting the State

The block can reset its state to the specified initial condition based on an external signal. To cause the block to reset its state, select one of the **External reset** choices. A trigger port appears below the block's input port and indicates the trigger type, as shown in this figure.

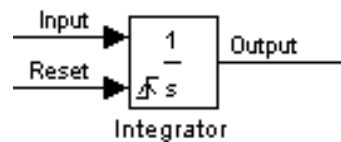

- Select rising to reset the state when the reset signal rises from a zero to a positive value or from a negative to a positive value.
- Select falling to reset the state when the reset signal falls from a positive value to zero or from a positive to a negative value.
- Select either to reset the state when the reset signal changes from a zero to a nonzero value or changes sign.
- Select level1 to reset the state when the reset signal is nonzero at the current time step or changes from nonzero at the previous time step to zero at the current time step.
- Select level1 hold to reset the state when the reset signal is nonzero at the current time step.

The reset port has direct feedthrough. If the block output is fed back into this port, either directly or through a series of blocks with direct feedthrough, an algebraic loop results (see “Algebraic Loops”). The Integrator block's state port allows you to feed back the block's output without creating an algebraic loop.

---

**Note** To be compliant with the Motor Industry Software Reliability Association (MISRA) software standard, your model must use Boolean signals to drive the external reset ports of Integrator blocks.

---

## About the State Port

Selecting the **Show state port** option on the Integrator block's parameter dialog box causes an additional output port, the state port, to appear atop the Integrator block.

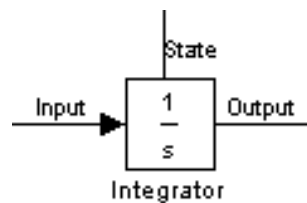

The output of the state port is the same as the output of the block's standard output port except for the following case. If the block is reset in the current time step, the output of the state port is the value that would have appeared at the block's standard output if the block had not been reset. The state port's output appears earlier in the time step than the output of the Integrator block's output port. This allows you to avoid creating algebraic loops in the following modeling scenarios:

- Self-resetting integrators (see “Creating Self-Resetting Integrators” on page 2-366)
- Handing off a state from one enabled subsystem to another (see “Handing Off States Between Enabled Subsystems” on page 2-367)

---

**Note** When updating a model, Simulink checks to ensure that the state port is being used in one of these two scenarios. If not, Simulink signals an error. Also, Simulink does not allow you to log the output of this port in a referenced model that executes in Accelerator mode. If logging is enabled for the port, Simulink generates a "signal not found" warning during execution of the referenced model.

---

## Creating Self-Resetting Integrators

The Integrator block's state port allows you to avoid creating algebraic loops when creating an integrator that resets itself based on the value of its output. Consider, for example, the following model.

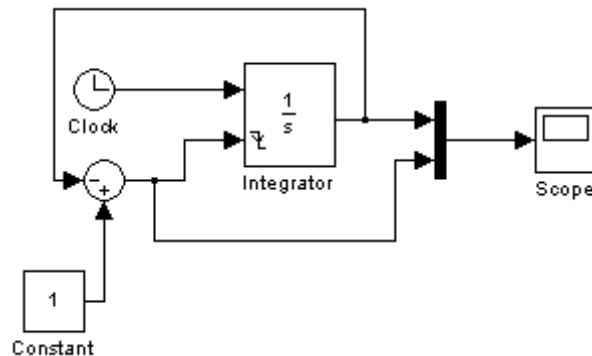

This model tries to create a self-resetting integrator by feeding the integrator's output, subtracted from 1, back into the integrator's reset port. In so doing, however, the model creates an algebraic loop. To compute the integrator block's output, Simulink needs to know the value of the block's reset signal, and vice versa. Because the two values are mutually dependent, Simulink cannot determine either. It therefore signals an error if you try to simulate or update this model.

The following model uses the integrator's state port to avoid the algebraic loop.

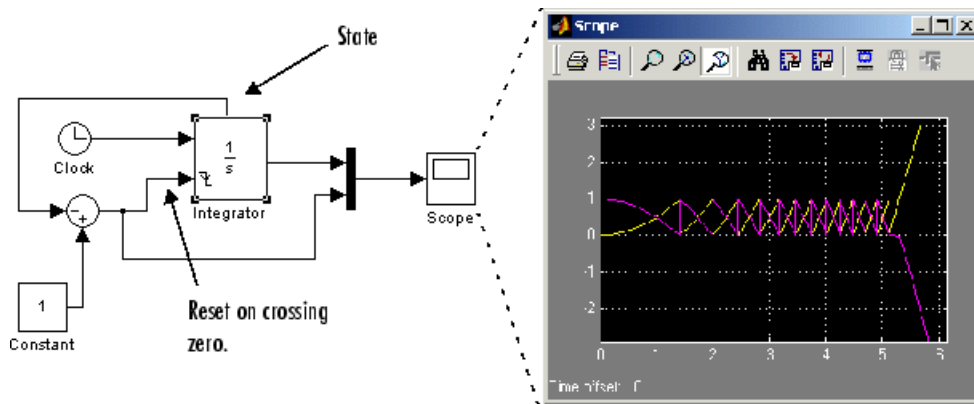

In this version, the value of the reset signal depends on the value of the state port. The value of the state port is available earlier in the current time step than the value of the integrator block's output port. Thus, Simulink can determine whether the block needs to be reset before computing the block's output, thereby avoiding the algebraic loop.

## Handing Off States Between Enabled Subsystems

The state port allows you to avoid an algebraic loop when passing a state between two enabled subsystems. Consider, for example, the following model.

# Integrator

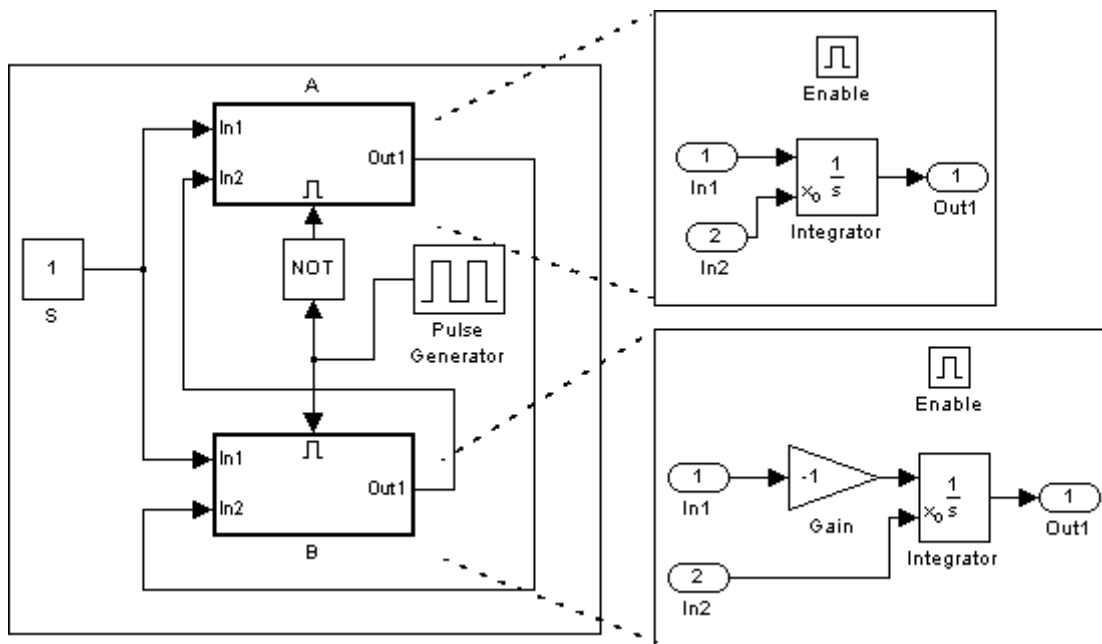

In this model, a constant input signal drives two enabled subsystems that integrate the signal. A pulse generator generates an enabling signal that causes execution to alternate between the two subsystems. The enable port of each subsystem is set to reset. This causes the subsystem to reset its integrator when it becomes active. Resetting the integrator causes the integrator to read the value of its initial condition port. The initial condition port of the integrator in each subsystem is connected to the output port of the integrator in the other subsystem.

This connection is intended to enable continuous integration of the input signal as execution alternates between the two subsystems. However, the connection creates an algebraic loop. To compute the output of A, Simulink needs to know the output of B, and vice versa. Because the outputs are mutually dependent, Simulink cannot compute them. It therefore generates an error if you attempt to update or simulate this model.

The following version of the same model uses the integrator state port to avoid creating an algebraic loop when handing off the state.

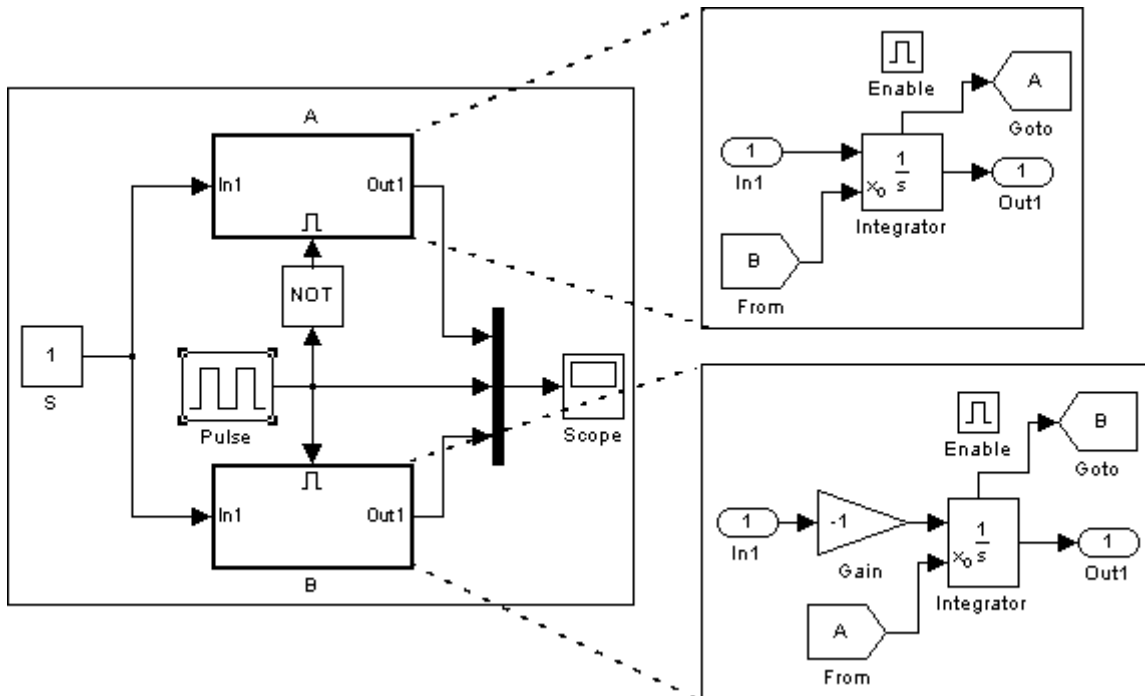

In this model, the initial condition of the integrator in A depends on the value of the state port of the integrator in B, and vice versa. The values of the state ports are updated earlier in the simulation time step than the values of the integrator output ports. Thus, Simulink can compute the initial condition of either integrator without knowing the final output value of the other integrator. For another example of using the state port to hand off states between conditionally executed subsystems, see the `sldemo_clutch` model.

---

**Note** Simulink does not permit three or more enabled subsystems to hand off a model state. If Simulink detects that a model is handing off a state among more than two enabled subsystems, it generates an error.

---

## Specifying the Absolute Tolerance for the Block's Outputs

By default Simulink uses the absolute tolerance value specified in the **Configuration Parameters** dialog box (see “Specifying Variable-Step Solver Error Tolerances”) to compute the output of the Integrator block. If this value does not provide sufficient error control, specify a more appropriate value in the **Absolute tolerance** field of the Integrator block's dialog box. The value that you specify is used to compute all of the block's outputs.

## Choosing All Options

When all options are selected, the icon looks like this.

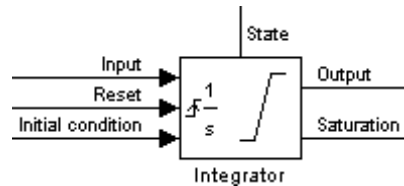

## Data Type Support

The Integrator block accepts and outputs signals of type double on its data ports. Its external reset port accepts signals of type double or Boolean.



## Parameters and Dialog Box

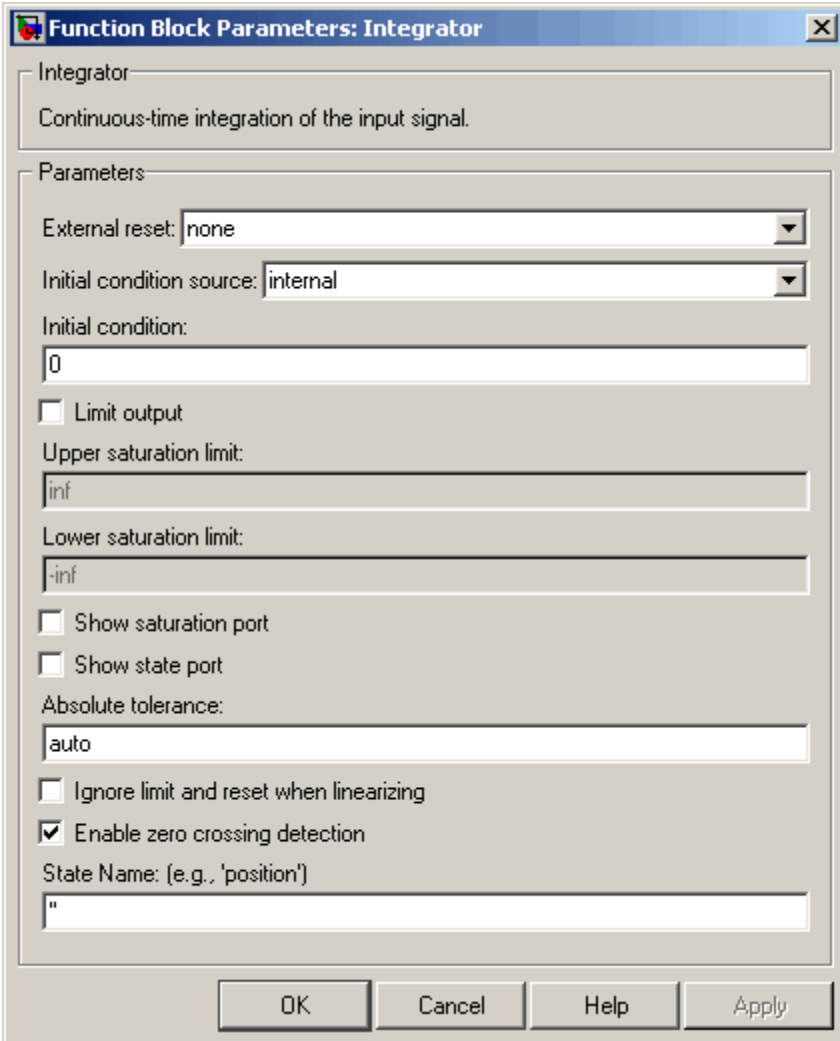

The dialog box is titled "Function Block Parameters: Integrator" and contains the following fields and options:

- Integrator**: Continuous-time integration of the input signal.
- Parameters**:
  - External reset: none
  - Initial condition source: internal
  - Initial condition: 0
  - Limit output
  - Upper saturation limit: inf
  - Lower saturation limit: -inf
  - Show saturation port
  - Show state port
  - Absolute tolerance: auto
  - Ignore limit and reset when linearizing
  - Enable zero crossing detection
  - State Name: (e.g., 'position')

Buttons: OK, Cancel, Help, Apply

### External reset

Resets the states to their initial conditions when a trigger event (rising, falling, either, or level) occurs in the reset signal.

**Initial condition source**

Gets the states' initial conditions from the **Initial condition** parameter (if set to `internal`) or from an external block (if set to `external`).

**Initial condition**

The states' initial conditions. Set the **Initial condition source** parameter value to `internal`. Simulink does not allow the initial condition of this block to be `inf` or `NaN`.

**Limit output**

If selected, limits the states to a value between the **Lower saturation limit** and **Upper saturation limit** parameters.

**Upper saturation limit**

The upper limit for the integral. The default is `inf`.

**Lower saturation limit**

The lower limit for the integral. The default is `-inf`.

**Show saturation port**

If selected, adds a saturation output port to the block.

**Show state port**

If selected, adds an output port to the block for the block's state.

**Absolute tolerance**

Absolute tolerance used to compute the block's outputs. You can enter `auto` or a numeric value. If you enter `auto`, Simulink determines the absolute tolerance (see "Specifying Variable-Step Solver Error Tolerances"). If you enter a numeric value, Simulink uses the specified value to compute the block's outputs. Note that a numeric value overrides the setting for the absolute tolerance in the **Configuration Parameters** dialog box.

**Ignore limit and reset when linearizing**

Select this option to cause Simulink linearization commands to treat this block as unresettable and as having no limits on its output, regardless of the settings of the block's reset and output limitation options. This allows you to linearize a model around an operating point that causes the integrator to reset or saturate.

## Enable zero crossing detection

If this option, **Limit output**, and zero-crossing detection for the model as a whole are selected, the Integrator block uses zero-crossings to detect and take a time step at any of the following events: reset, entering or leaving an upper saturation state, entering or leaving a lower saturation state. For more information, see “Zero-Crossing Detection” in the “How Simulink Works” chapter of the Using Simulink documentation.

## State Name

Use this to assign a unique name to each state. The state names apply only to the selected block. If left blank, no name is assigned.

To assign a name to a single state, enter the name between quotes, for example, 'velocity' .

To assign names to multiple states, enter a comma-delimited list surrounded by braces. For example, { 'a' , 'b' , 'c' } . Each name must be unique.

The number of states must be evenly divided by the number of state names. There can be fewer names than states, but there cannot be more names than states.

For example, you can specify two names in a system with four states. Simulink will assign the first name to the first two states and the second name to the last two.

To assign state names with a variable that has been defined in the MATLAB workspace, enter the variable without quotes. A variable can be a string, cell, or structure.

## Characteristics

Direct Feedthrough	Yes, of the reset and external initial condition source ports
Sample Time	Continuous

# Integrator

---

Scalar Expansion	Yes, of parameters
States	Inherited from driving block or parameter
Dimensionalized	Yes
Zero Crossing	Yes, if enabled and you select the <b>Limit output</b> option, one for detecting reset, one each to detect upper and lower saturation limits, one when leaving saturation

# Interpolation (n-D) Using PreLookup (Obsolete)

## Purpose

Perform high-performance constant or linear interpolation, mapping  $N$  input values to sampled representation of function in  $N$  variables via output from PreLookup Index Search block

## Library

Lookup Tables

## Description

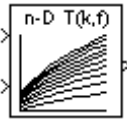

**Note** The Interpolation (n-D) Using PreLookup block is currently supported, but The MathWorks plans to remove this block in a future release. Use the Interpolation Using Prelookup block instead. Among other enhancements, the Interpolation Using Prelookup block provides support for fixed-point data types, consistency checking, and more efficient code generation.

The Interpolation (n-D) Using PreLookup block is intended for use with the PreLookup Index Search (Obsolete) block. The PreLookup Index Search block calculates the index and interval fraction that specifies how its input value relates to the breakpoint data set. You feed the resulting (index, fraction) pair into an Interpolation (n-D) Using PreLookup block to interpolate an  $n$ -dimensional table. This combination of blocks performs the equivalent operation that a single instance of the Lookup Table (n-D) block performs. But by using these blocks instead, you can potentially increase the simulation performance of models that use many interpolation blocks.

This block supports two interpolation methods: flat (constant) interval lookup and linear interpolation. These operations can be applied to 1-D, 2-D, 3-D, 4-D and higher dimensioned tables.

You define a set of output values as the **Table data** parameter. These table values must correspond to the breakpoint data sets specified in the PreLookup Index Search blocks. For example, the following model illustrates the use of an Interpolation (n-D) Using PreLookup block with two PreLookup Index Search blocks:

# Interpolation (n-D) Using PreLookup (Obsolete)

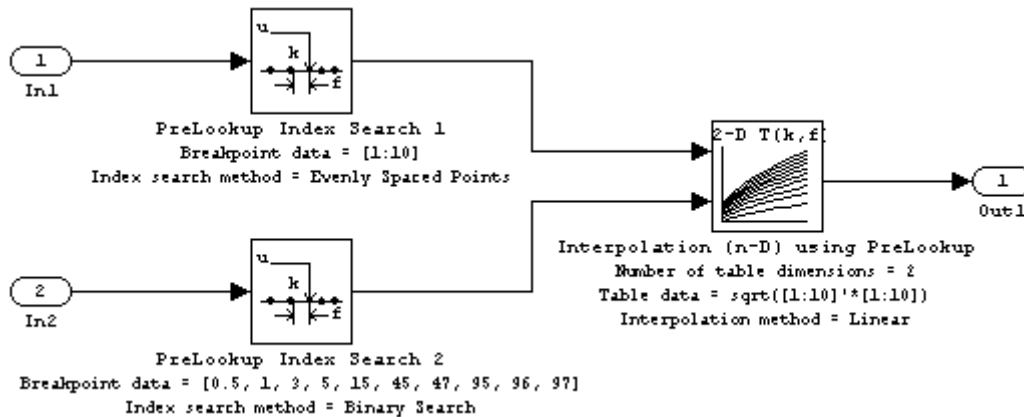

The breakpoint data set in the first PreLookup Index Search block contains 10 breakpoints, while that of the second PreLookup Index Search block contains 10 breakpoints. Consequently, the Interpolation (n-D) Using PreLookup block's table data is of size 10-by-10.

The block generates its output by interpolating the table values based on the (index, fraction) pairs fed into the block by each PreLookup Index Search block:

- If the inputs match breakpoint parameter values, the output is the table value at the intersection of the row, column, and higher dimensions' breakpoints.
- If the inputs do not match row and column parameter values, the block generates output by interpolating between the appropriate table values. If either or both block inputs are less than the first or greater than the last row or column parameter values, the block extrapolates from the first two or last two points in each corresponding dimension.

The block can perform interpolation on a portion of the table. For more information, see Lookups: Prelookup and Sub-Table Interpolation Blocks in the **Simulink > Modeling Features** section on the MATLAB Help browser's **Demos** pane.

# Interpolation (n-D) Using PreLookup (Obsolete)

## Data Type Support

The Interpolation (n-D) Using PreLookup block accepts signals of types `double` or `single`, but for any given block, the inputs must all be of the same type. The **Table data** parameter must be of the same type as the inputs. The output data type is set to the **Table data** data type.

## Parameters and Dialog Box

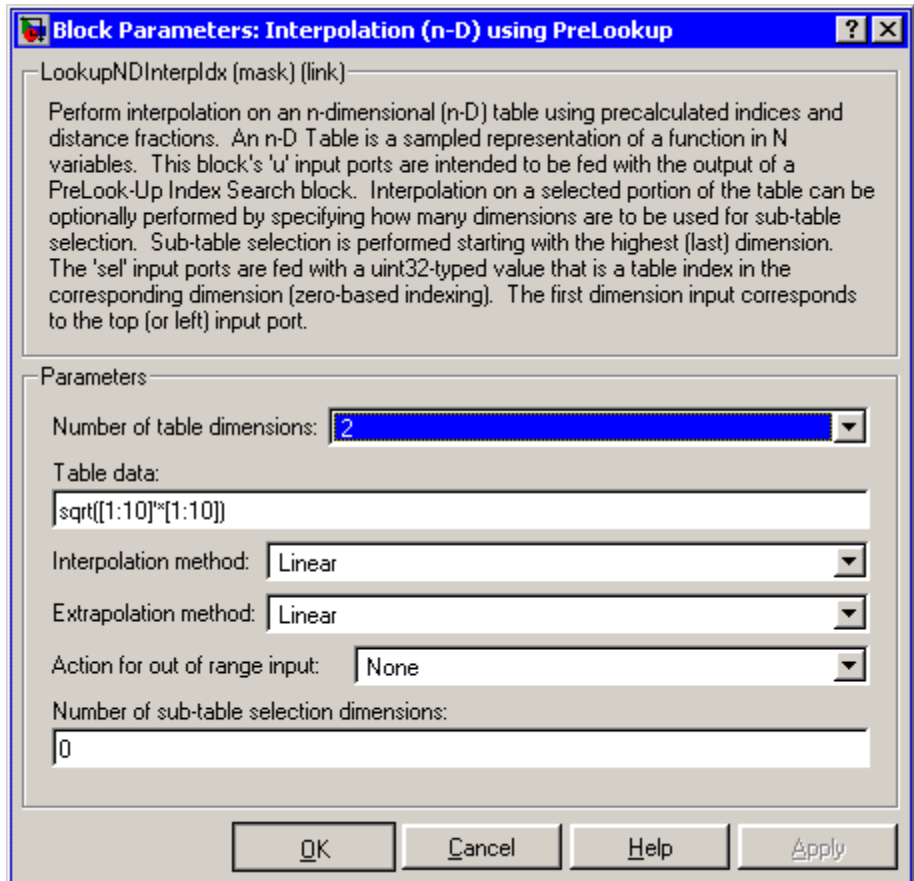

### Number of table dimensions

The number of dimensions that the **Table data** parameter must have. This determines the number of independent variables for

# Interpolation (n-D) Using PreLookup (Obsolete)

---

the table and hence the number of inputs to the block. If the number of table dimensions exceeds four, select the More . . . option to access the **Explicit number of table dimensions** field and enter a number between 1 and 30.

## Table data

The table of output values. The matrix size must match the dimensions defined by the **Number of table dimensions** parameter or by the **Explicit number of table dimensions** parameter when the number of dimensions exceeds four. During block diagram editing, you can leave the **Table data** field empty, but for running the simulation, you must match the number of dimensions in the **Table data** parameter to the **Number of table dimensions** or **Explicit number of table dimensions**. For information about how to construct multidimensional arrays in MATLAB, see “Multidimensional Arrays”.

## Interpolation method

None (flat) or Linear.

## Extrapolation method

None (clip) or Linear.

## Action for out of range input

Specifies whether to produce a warning or error message if the input is out of range. Options include:

- None
- Warning
- Error
- Error - No index checking in generated code
- Warning - No index checking in generated code
- None - No index checking in generated code



# Interpolation (n-D) Using PreLookup (Obsolete)

---

## Number of sub-table selection dimensions

Number of dimensions of the subtable used to compute this block's output. Specify 0 to use the entire table specified by **Table data** parameter.

## Characteristics

Direct Feedthrough	Yes
Sample Time	Inherited from driving blocks
Scalar Expansion	Yes
Zero Crossing	No

## See Also

PreLookup Index Search (Obsolete)

# Interpolation Using Prelookup

## Purpose

Use output of Prelookup block to accelerate approximation of N-dimensional function

## Library

Lookup Tables

## Description

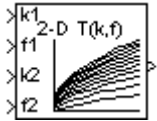

The Interpolation Using Prelookup block is intended for use with the Prelookup block. The Prelookup block calculates the index and interval fraction that specifies how its input value relates to the breakpoint data set. You feed the resulting index and fraction values into an Interpolation Using Prelookup block to interpolate an  $n$ -dimensional table. This combination of blocks performs the equivalent operation that a single instance of the Lookup Table (n-D) block performs. However, the Prelookup and Interpolation Using Prelookup blocks offer greater flexibility that can result in more efficient simulation performance.

To use this block, you must define a set of output values as the **Table data** parameter. In normal use, these table values correspond to the breakpoint data sets specified in Prelookup blocks. The Interpolation Using Prelookup block generates its output by looking up or estimating table values based on the index and interval fraction values (denoted on the block as  $k$  and  $f$ , respectively) fed into the block by each Prelookup block:

- If the inputs match the values of indices specified in breakpoint data sets, the Interpolation Using Prelookup block outputs the table value at the intersection of the row, column, and higher dimension breakpoints.
- If the inputs do not match the values of indices specified in breakpoint data sets, the Interpolation Using Prelookup block generates output by interpolating appropriate table values. If the inputs are beyond the range of breakpoint data sets, the Interpolation Using Prelookup block can extrapolate its output value.

The Interpolation Using Prelookup block can perform interpolation on a portion of its table. The **Number of sub-table selection dimensions** parameter lets you specify that interpolation occur only on a subset of its **Table data** parameter. For example, if your 3-D table data constitutes

a stack of 2-D tables to be interpolated, set the **Number of sub-table selection dimensions** parameter to 1. The block displays an input port (labeled as sel) used to select and interpolate the 2-D tables.

## Data Type Support

The Interpolation Using Prelookup block accepts real signals of any data type supported by Simulink, except Boolean. The Interpolation Using Prelookup block supports fixed-point data types.

For a discussion on the data types supported by Simulink, see “Data Types Supported by Simulink” in the Simulink documentation.

# Interpolation Using Prelookup

## Parameters and Dialog Box

The **Main** pane of the Interpolation Using Prelookup block dialog appears as follows:

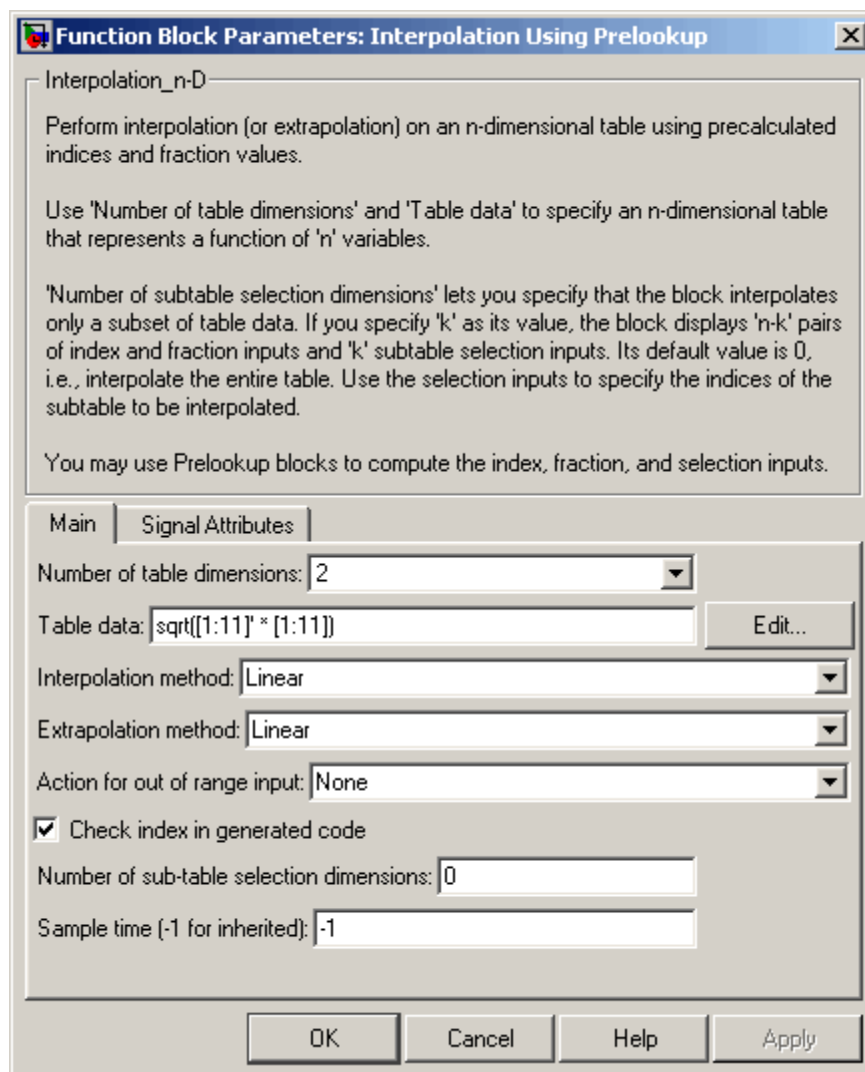

## Number of table dimensions

The number of dimensions that the **Table data** parameter must have. This determines the number of independent variables for the table and hence the number of inputs to the block. Enter an integer between 1 and 30 into this field.

## Table data

The table of output values. During simulation, the matrix size must match the dimensions defined by the **Number of table dimensions** parameter. But note that during block diagram editing, you can enter either an empty matrix (specified as `[]`) or an undefined workspace variable as the **Table data** parameter. This allows you to postpone specifying a correctly dimensioned matrix for the **Table data** parameter and continue editing the block diagram. For information about how to construct multidimensional arrays in MATLAB, see “Multidimensional Arrays” in the MATLAB Programming documentation.

---

**Note** At runtime, the Interpolation Using Prelookup block converts the data type of its **Table data** parameter to that of its output.

---

Click the **Edit** button to open the Lookup Table Editor (see “Lookup Table Editor” in the Simulink documentation).

## Interpolation method

None - Flat or Linear. See “Interpolation Methods” in the Simulink documentation for more information.

## Extrapolation method

None - Clip or Linear. See “Extrapolation Methods” in the Simulink documentation for more information. The **Extrapolation method** parameter is visible only if you select Linear as the **Interpolation method** parameter.

# Interpolation Using Prelookup

---

---

**Note** The Interpolation Using Prelookup block does not support Linear extrapolation if its input or output signals specify integer or fixed-point data types.

---

## Action for out of range input

Specifies whether to produce a warning or error message if the input is out of range. The options are

- None — the default, no warning or error message
- Warning — display a warning message in the MATLAB Command Window and continue the simulation
- Error — halt the simulation and display an error message in the Simulation Diagnostics Viewer

## Check index in generated code (Real-Time Workshop license required)

Specifies whether Real-Time Workshop generates code that checks the validity of the index values fed to this block.

## Valid index input may reach last index

Specifies how the index and interval fraction inputs to the block (labeled respectively as **k** and **f** on the block) access the last elements of the  $n$ -dimensional table specified by the **Table data** parameter. If enabled, the block returns the value of the last element in a particular dimension of its table when **k** indexes the last table element in the corresponding dimension and **f** is 0. If disabled, the block returns the value of the last element in a particular dimension of its table when **k** indexes the next-to-last table element in the corresponding dimension and **f** is 1. Note that index values are zero-based.

This parameter is visible only if the **Interpolation method** specifies Linear and the **Extrapolation method** is None - Clip.

---

**Note** If you enable the **Valid index input may reach last index** parameter for an Interpolation Using Prelookup block, you must also enable the **Use last breakpoint for input at or above upper limit** parameter for all Prelookup blocks that feed it. This allows the blocks to use the same indexing convention when accessing the last elements of their **Breakpoint data** and **Table data** parameters.

---

### **Number of sub-table selection dimensions**

Specifies the number of dimensions of the subtable used to compute this block's output. Specify 0 (the default) to interpolate the entire table, effectively disabling subtable selection.

### **Sample time**

Specify the time interval between samples. To inherit the sample time, set this parameter to -1. See "Specifying Sample Time" in the Simulink documentation for more information.

The **Signal Attributes** pane of the Interpolation Using Prelookup block dialog appears as follows:

# Interpolation Using Prelookup

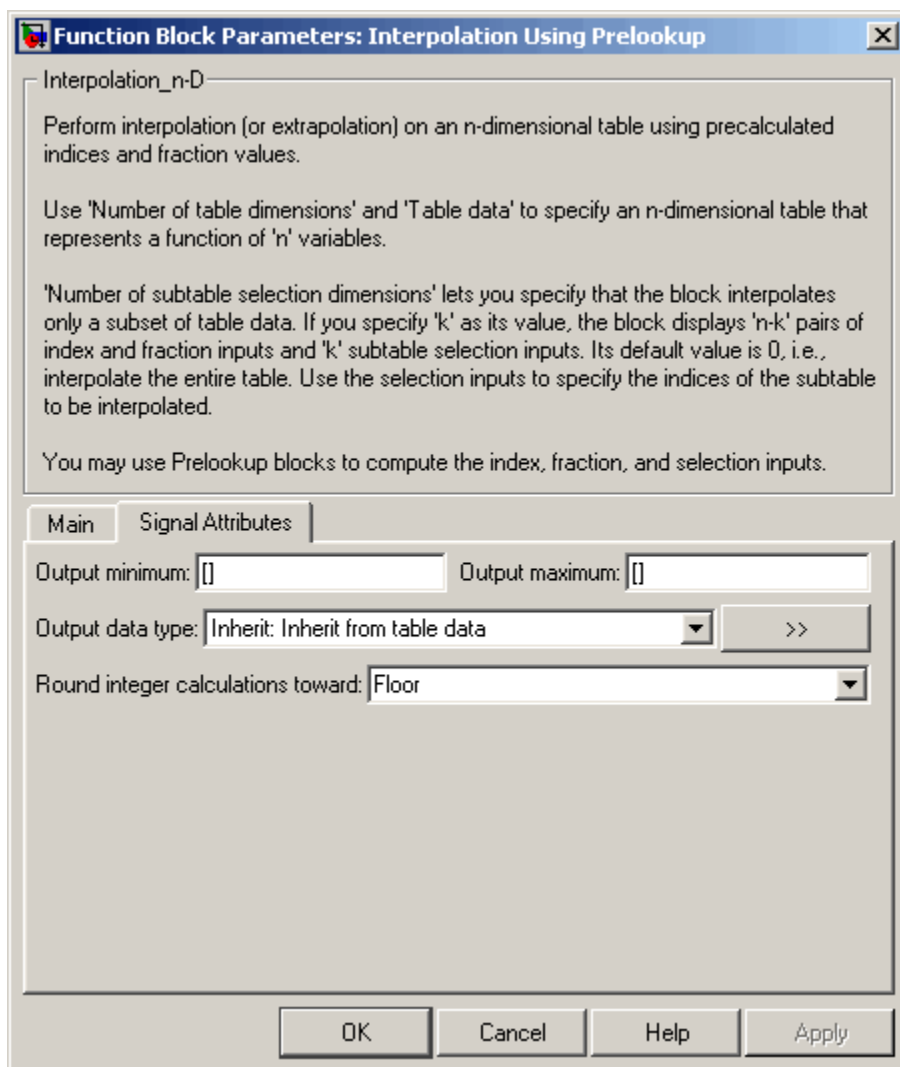



## Output minimum

Specify the minimum value that the block should output. The default value, [], is equivalent to `-Inf`. Simulink uses this value to perform:

- Parameter range checking (see “Checking Parameter Values”)
- Simulation range checking (see “Checking Signal Ranges”)
- Automatic scaling of fixed-point data types

## Output maximum

Specify the maximum value that the block should output. The default value, [], is equivalent to `Inf`. Simulink uses this value to perform:

- Parameter range checking (see “Checking Parameter Values”)
- Simulation range checking (see “Checking Signal Ranges”)
- Automatic scaling of fixed-point data types

## Output data type

Specify the output data type. You can set it to:

- A rule that inherits a data type, for example, `Inherit: Inherit via back propagation`
- The name of a built-in data type, for example, `single`
- The name of a data type object, for example, a `Simulink.NumericType` object
- An expression that evaluates to a data type, for example, `float('single')`

Click the **Show data type assistant** button  to display the **Data Type Assistant**, which helps you set the **Output data type** parameter.

See “Specifying Block Output Data Types” in *Using Simulink* for more information.

# Interpolation Using Prelookup

---

## **Lock output scaling against changes by the autoscaling tool**

Select to lock scaling of outputs. This parameter is visible only if you enter an expression for the **Output data type** parameter.

## **Round integer calculations toward**

Select the rounding mode for fixed-point operations.

Block parameters such as **Table data** are always rounded to the nearest representable value. To control the rounding of a block parameter, enter an expression using a MATLAB rounding function into the mask field.

## **Characteristics**

Direct Feedthrough	Yes
Sample Time	Specified in the <b>Sample time</b> parameter
Scalar Expansion	Yes
Dimensionalized	Yes
Zero Crossing	No

## **See Also**

Prelookup

**Purpose** Determine if signal is in specified interval

**Library** Logic and Bit Operations

## Description

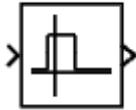

The Interval Test block outputs TRUE if the input is between the values specified by the **Lower limit** and **Upper limit** parameters. The block outputs FALSE if the input is outside those values. The output of the block when the input is equal to the **Lower limit** or the **Upper limit** is determined by whether the boxes next to **Interval closed on left** and **Interval closed on right** are selected in the dialog box.

## Data Type Support

The Interval Test block accepts signals of any data type supported by Simulink, including fixed-point data types.

## Parameters and Dialog Box

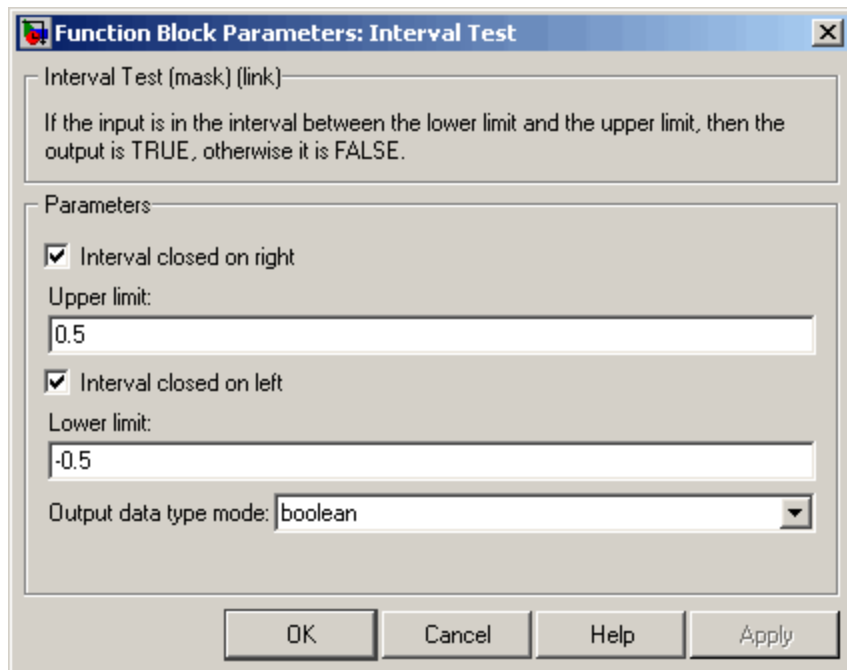

# Interval Test

---

## **Interval closed on right**

When you select this check box, the **Upper limit** is included in the interval for which the block outputs TRUE.

## **Upper limit**

The upper limit of the interval for which the block outputs TRUE.

## **Interval closed on left**

When you select this check box, the **Lower limit** is included in the interval for which the block outputs TRUE.

## **Lower limit**

The lower limit of the interval for which the block outputs TRUE.

## **Output data type mode**

Select the output data type; boolean or uint8.

## **Characteristics**

Direct Feedthrough	Yes
Scalar Expansion	Yes

## **See Also**

Interval Test Dynamic

**Purpose** Determine if signal is in specified interval

**Library** Logic and Bit Operations

## Description

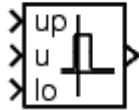

The Interval Test Dynamic block outputs TRUE if the input is between the values of the external signals up and lo. The block outputs FALSE if the input is outside those values. The output of the block when the input is equal to the signal up or the signal lo is determined by whether the boxes next to **Interval closed on left** and **Interval closed on right** are selected in the dialog box.

## Data Type Support

The Interval Test Dynamic block accepts signals of any data type supported by Simulink, including fixed-point data types.

## Parameters and Dialog Box

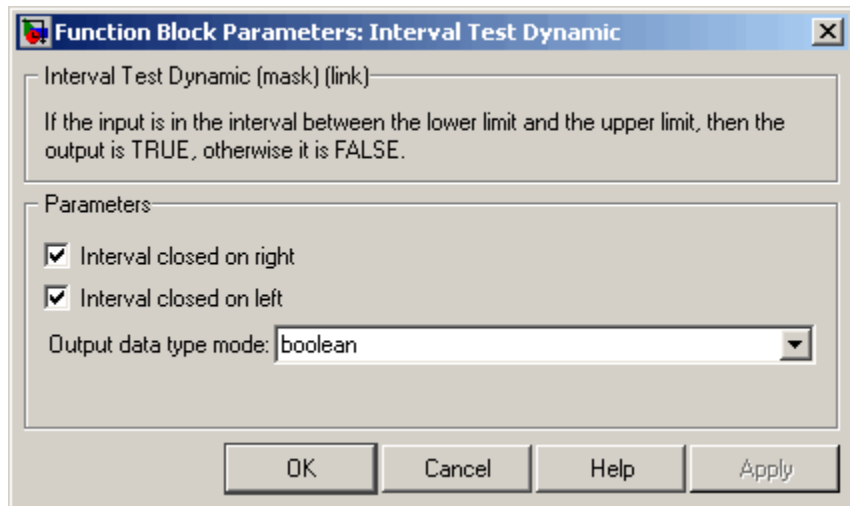

### Interval closed on right

When you select this check box, the value of the signal connected to the block's "up" input port is included in the interval for which the block outputs TRUE.

# Interval Test Dynamic

---

## Interval closed on left

When you select this check box, the value of the signal connected to the block's "lo" input port is included in the interval for which the block outputs TRUE.

## Output data type mode

Select the output data type; boolean or uint8.

## Characteristics

Direct Feedthrough	Yes
Scalar Expansion	Yes

## See Also

Interval Test

**Purpose** Use Level-2 M-file S-function in model

**Library** User-Defined Functions

**Description**



This block allows you to use a Level-2 M-file S-function (see “Writing Level-2 M-File S-Functions”) in a model. To do this, create an instance of this block in the model. Then enter the name of the Level-2 M-File S-function in the **M-file name** field of the block’s parameter dialog box.

---

**Note** Use the S-Function block to include a Level-1 M-file S-function in a block.

---

If the Level-2 M-file S-function defines any additional parameters, you can enter them in the **Parameters** field of the block’s parameter dialog box. Enter them as MATLAB expressions that evaluate to their values in the order defined by the M-file S-function. Use commas to separate each expression.

If a model includes a Level-2 M-File S-Function block, and an error occurs in the S-function, the Level-2 M-File S-Function block displays M-file stack trace information for the error in a dialog box. Click **OK** to remove the dialog box.

**Data Type Support**

Depends on the M-file that defines the behavior of a particular instance of this block.

# Level-2 M-File S-Function

## Parameters and Dialog Box

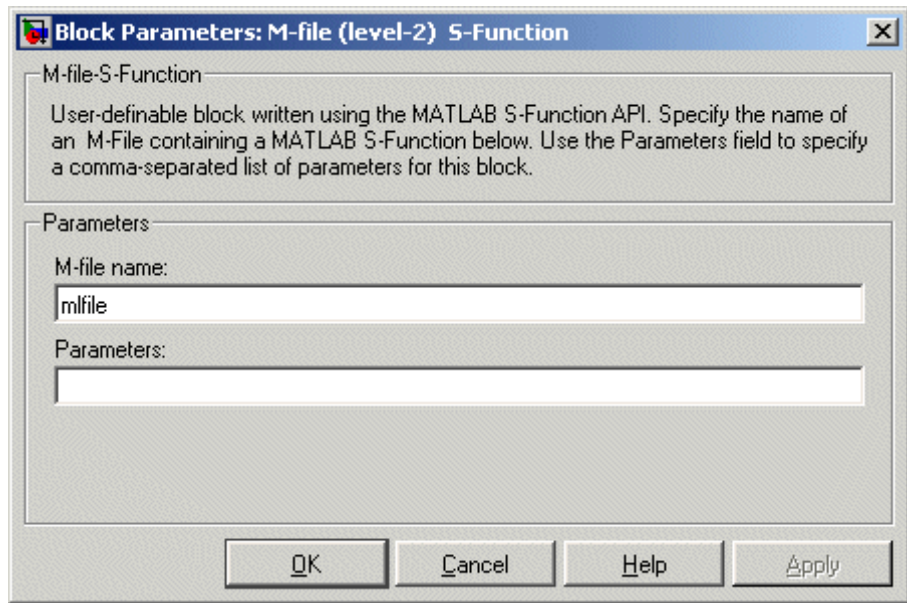

### M-file name

Name of an M-file that defines the behavior of this block. The M-file must follow the Level-2 standard for writing M-file S-functions (see “Writing Level-2 M-File S-Functions”).

### Parameters

Values of the parameters of this block.

### Characteristics

Direct Feedthrough	Depends on the M-file S-function
Sample Time	Depends on the M-file S-function
Scalar Expansion	Depends on contents M-file S-function
Dimensionalized	Depends on the M-file S-function



## Level-2 M-File S-Function

---

Multidimensionalized	Yes
Zero Crossing	No

# Logical Operator

---

**Purpose** Perform specified logical operation on input

**Library** Logic and Bit Operations

**Description**



The Logical Operator block performs the specified logical operation on its inputs. An input value is TRUE (1) if it is nonzero and FALSE (0) if it is zero.

You select the Boolean operation connecting the inputs with the **Operator** parameter list. If you select rectangular as the **Icon shape** property, the block updates to display the name of the selected operator. The supported operations are given below.

Operation	Description
AND	TRUE if all inputs are TRUE
OR	TRUE if at least one input is TRUE
NAND	TRUE if at least one input is FALSE
NOR	TRUE when no inputs are TRUE
XOR	TRUE if an odd number of inputs are TRUE
NOT	TRUE if the input is FALSE

If you select distinctive as the **Icon shape**, the block's appearance indicates its function. Simulink displays a distinctive shape for the selected operator, conforming to the IEEE Standard Graphic Symbols for Logic Functions:

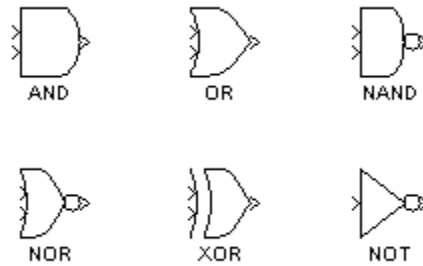

The number of input ports is specified with the **Number of input ports** parameter. The output type is specified with the **Output data type** parameter. An output value is 1 if TRUE and 0 if FALSE.

---

**Note** The output data type should represent zero exactly. Data types that satisfy this condition include signed and unsigned integers, and any floating-point data type.

---

The size of the output depends on input vector size and the selected operator:

- If the block has more than one input, any nonscalar inputs must have the same dimensions. For example, if any input is a 2-by-2 array, all other nonscalar inputs must also be 2-by-2 arrays.

Scalar inputs are expanded to have the same dimensions as the nonscalar inputs.

If the block has more than one input, the output has the same dimensions as the inputs (after scalar expansion) and each output element is the result of applying the specified logical operation to the corresponding input elements. For example, if the specified operation is AND and the inputs are 2-by-2 arrays, the output is a 2-by-2 array whose top left element is the result of applying AND to the top left elements of the inputs, etc.

# Logical Operator

---

- For a single vector input, the block applies the operation (except the NOT operator) to all elements of the vector. The output is always a scalar.
- The NOT operator accepts only one input, which can be a scalar or a vector. If the input is a vector, the output is a vector of the same size containing the logical complements of the input vector elements.

When configured as a multi-input XOR gate, this block performs an addition- modulo-two operation as mandated by the IEEE Standard for Logic Elements.

## Data Type Support

The Logical Operator block accepts real or complex signals of any data type supported by Simulink, including fixed-point data types.

For a discussion on the data types supported by Simulink, see “Data Types Supported by Simulink” in the Simulink documentation.

## Parameters and Dialog Box

The **Main** pane of the Logical Operator block dialog appears as follows:

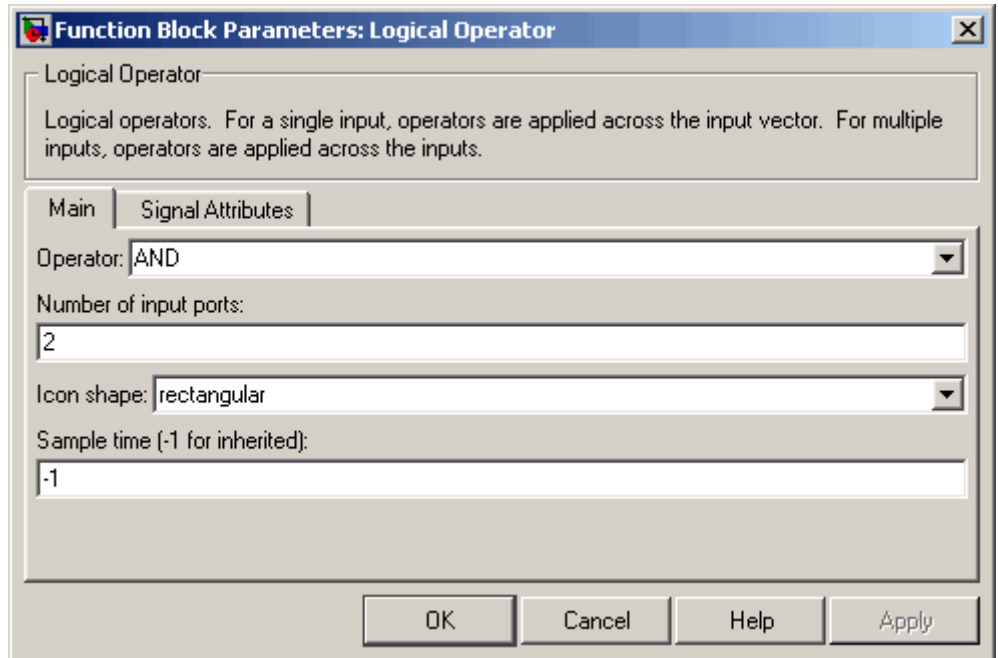

### Operator

The logical operator to be applied to the block inputs. Valid choices are the operators listed previously.

### Number of input ports

The number of block inputs. The value must be appropriate for the selected operator.

### Icon shape

The shape of the block icon. Specifying *rectangular* (the default) results in a rectangular block that displays the name of the selected operator. The *distinctive* option uses the graphic symbol for the selected operator as specified by the IEEE standard.

# Logical Operator

---

## Sample time (-1 for inherited)

Specify the time interval between samples. To inherit the sample time, set this parameter to -1. See “Specifying Sample Time” in the online documentation for more information.

The **Signal Attributes** pane of the Logical Operator block dialog appears as follows:

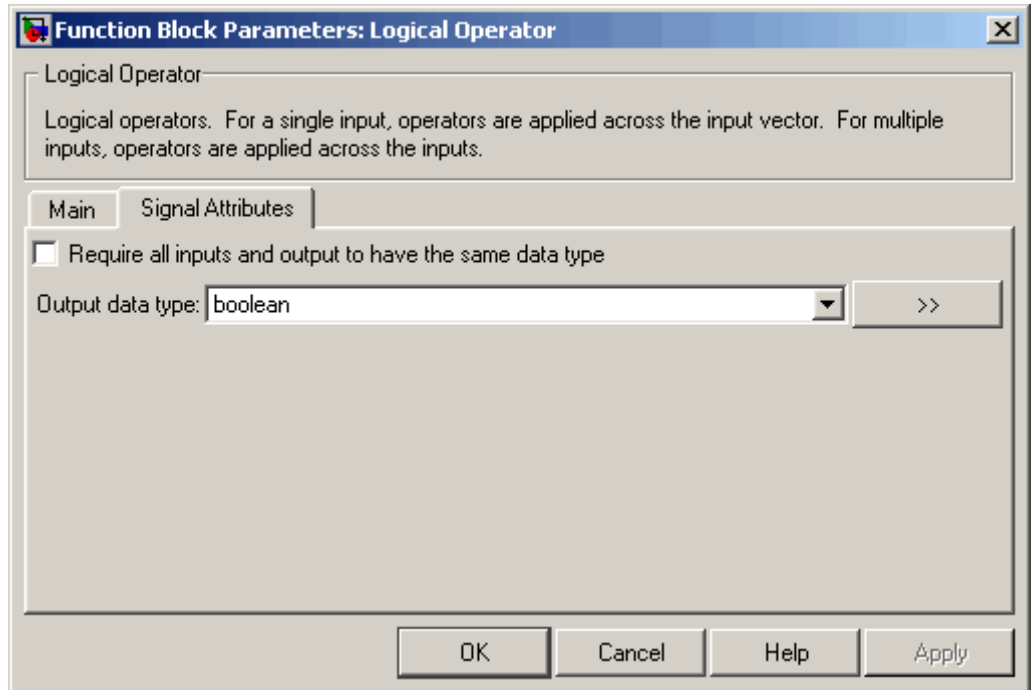

## Require all inputs and output to have the same data type

Select to require all inputs and the output to have the same data type.

## Output data type

Specify the output data type. You can set it to:

Option	Description
boolean	Specifies the output data type as boolean.
Inherit: Logical	Use the <b>Implement logic signals as boolean data</b> model configuration parameter (see “Implement logic signals as boolean data (vs. double)”) to specify the output data type.  <b>Note</b> This option is intended to support models created before the boolean option became available. Use one of the other options, preferably boolean, for new models.

Click the **Show data type assistant** button  to display the **Data Type Assistant**, which helps you set the **Output data type** parameter.

See “Specifying Block Output Data Types” in *Using Simulink* for more information.

---

**Note** You should use data types that represent zero exactly. Data types that satisfy this condition include signed and unsigned integers and any floating-point data type.

---

## Characteristics

Direct Feedthrough	Yes
Sample Time	Specified in the <b>Sample time</b> parameter
Scalar Expansion	Yes, of inputs
Dimensionalized	Yes

# Logical Operator

---

Multidimensionalized	Yes
Zero Crossing	No



**Purpose** Approximate one-dimensional function

**Library** Lookup Tables

**Description** The Lookup Table block computes an approximation to some function  $y=f(x)$  given data vectors  $x$  and  $y$ .

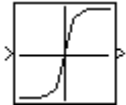

---

**Note** To map two inputs to an output, use the Lookup Table (2-D) block.

---

The length of the  $x$  and  $y$  data vectors provided to this block must match. Also, the  $x$  data vector must be *strictly monotonically increasing* (i.e., the value of the next element in the vector is greater than the value of the preceding element) after conversion to the input's fixed-point data type. However, the  $x$  data vector may be *monotonically increasing* (i.e., the value of the next element in the vector is greater than or equal to the value of the preceding element) if all of the following apply:

- The input and output signals are both either single or double.
- The lookup method is Interpolation-Extrapolation.

Note that due to quantization, the  $x$  data vector may be strictly monotonic in doubles format, but not so after conversion to a fixed-point data type.

You define the table by specifying the **Vector of input values** parameter as a 1-by- $n$  vector and the **Table data** parameter as a 1-by- $n$  vector. The block generates output based on the input values using one of these methods selected from the **Lookup method** parameter list:

- Interpolation-Extrapolation — This is the default method; it performs linear interpolation and extrapolation of the inputs.
  - If a value matches the block's input, the output is the corresponding element in the output vector.

# Lookup Table

---

- If no value matches the block's input, then the block performs linear interpolation between the two appropriate elements of the table to determine an output value. If the block input is less than the first or greater than the last input vector element, then the block extrapolates using the first two or last two points.

---

**Note** If the **Lookup method** parameter specifies Interpolation-Extrapolation, Real-Time Workshop can generate code for this block only if its input and output signals have the same floating-point data type.

---

- **Interpolation-Use End Values** — This method performs linear interpolation as described above but does not extrapolate outside the end points of the input vector. Instead, the end-point values are used.
- **Use Input Nearest** — This method does not interpolate or extrapolate. Instead, the element in  $x$  nearest the current input is found. The corresponding element in  $y$  is then used as the output.
- **Use Input Below** — This method does not interpolate or extrapolate. Instead, the element in  $x$  nearest and below the current input is found. The corresponding element in  $y$  is then used as the output. If there is no element in  $x$  below the current input, then the nearest element is found.
- **Use Input Above** — This method does not interpolate or extrapolate. Instead, the element in  $x$  nearest and above the current input is found. The corresponding element in  $y$  is then used as the output. If there is no element in  $x$  above the current input, then the nearest element is found.

---

**Note** Note that there is no difference among the **Use Input Nearest**, **Use Input Below**, and **Use Input Above** methods when the input  $x$  corresponds exactly to table breakpoints.

---

To create a table with step transitions, repeat an input value with different output values. For example, these input and output parameter values create the input/output relationship described by the plot that follows:

Vector of input values: [-2 -1 -1 0 0 0 1 1 2]  
Table data: [-1 -1 -2 -2 1 2 2 1 1]

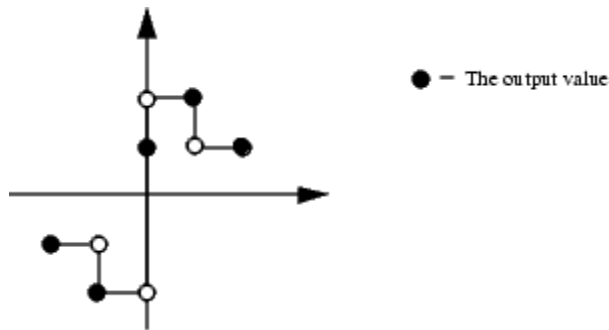

This example has three step discontinuities: at  $x = -1$ ,  $0$ , and  $+1$ .

When there are two output values for a given input value, the block chooses the output according to these rules:

- If the input signal  $u$  is less than zero, the block returns the output value associated with the last occurrence of the input value in the breakpoint data set. In this example, when  $u$  is  $-1$ ,  $y$  is  $-2$ , marked with a solid circle.
- If the input signal  $u$  is greater than zero, the block returns the output value associated with the first occurrence of the input value in the breakpoint data set. In this example, when  $u$  is  $1$ ,  $y$  is  $2$ , marked with a solid circle.
- If the input signal  $u$  is zero and there are two output values specified at the origin, the block returns the average of those output values. In this example, if there were no point defined at  $x = 0$  and  $y = 1$ , the output would be  $0$ , the average of the two points at  $u = 0$ . If there are three output values specified at the origin, the block generates the

# Lookup Table

---

output associated with the middle point. In this example, the output at the origin is 1, marked with a solid circle.

The Lookup Table icon displays a graph of the input vector versus the output vector. When a parameter is changed on the block's dialog box, the graph is automatically redrawn when you click the **OK** or **Apply** button.

To avoid parameter saturation errors, the automatic scaling script `autofixexp` employs a special rule for the Lookup Table block. `autofixexp` modifies the scaling by using the output lookup values in addition to the logged minimum and maximum simulation values. This prevents the data from being saturated to different values. The lookup values are given by the **Table data** parameter (the Table parameter).

## Data Type Support

The Lookup Table block supports all data types supported by Simulink, including fixed-point data types.

For a discussion on the data types supported by Simulink, see “Data Types Supported by Simulink” in the Simulink documentation.

## Parameters and Dialog Box

The **Main** pane of the Lookup Table block dialog appears as follows:

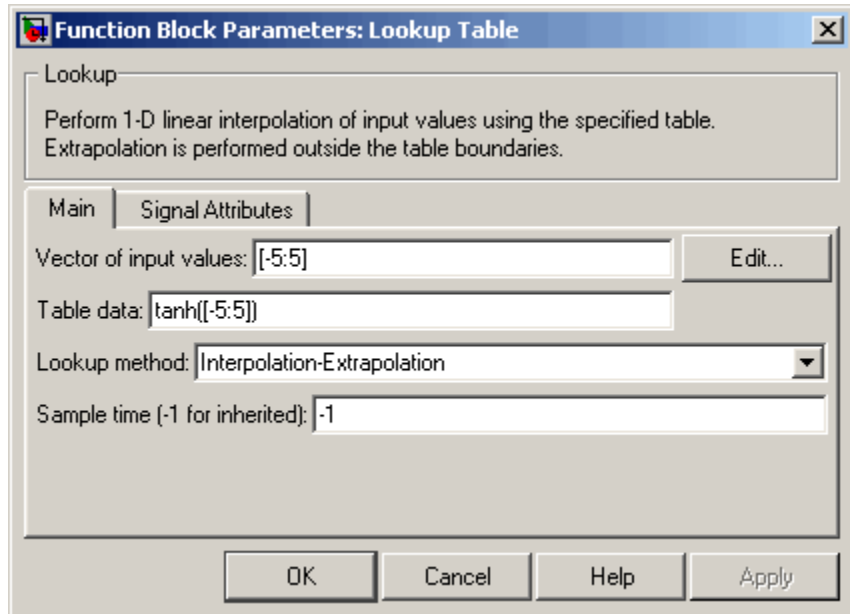

### Vector of input values

Specify the vector of input values. The input values vector must be the same size as the output values vector. Also, the input values vector must be strictly monotonically increasing after conversion to the input's fixed-point data type, except in the following case. If the input values vector and the output signal are both either single or double, and if the lookup method is Interpolation-Extrapolation, then the input values vector may be monotonically increasing rather than strictly monotonically increasing. Note that due to quantization, the input values vector may be strictly monotonic in doubles format, but not so after conversion to a fixed-point data type.

# Lookup Table

---

The **Vector of input values** parameter is converted from doubles to the input data type offline using round-to-nearest and saturation.

Click the **Edit** button to open the Lookup Table Editor (see “Lookup Table Editor” in the online Simulink documentation).

## **Table data**

Specify the vector of output values. The table data must be the same size as the input values vector.

The **Table data** parameter is converted from doubles to the output data type offline using round-to-nearest and saturation.

## **Lookup method**

Specify the lookup method. See Description for a discussion of the options for this parameter.

## **Sample time (-1 for inherited)**

Specify the time interval between samples. To inherit the sample time, set this parameter to -1. See “Specifying Sample Time” in the online documentation for more information.

The **Signal Attributes** pane of the Lookup Table block dialog appears as follows:

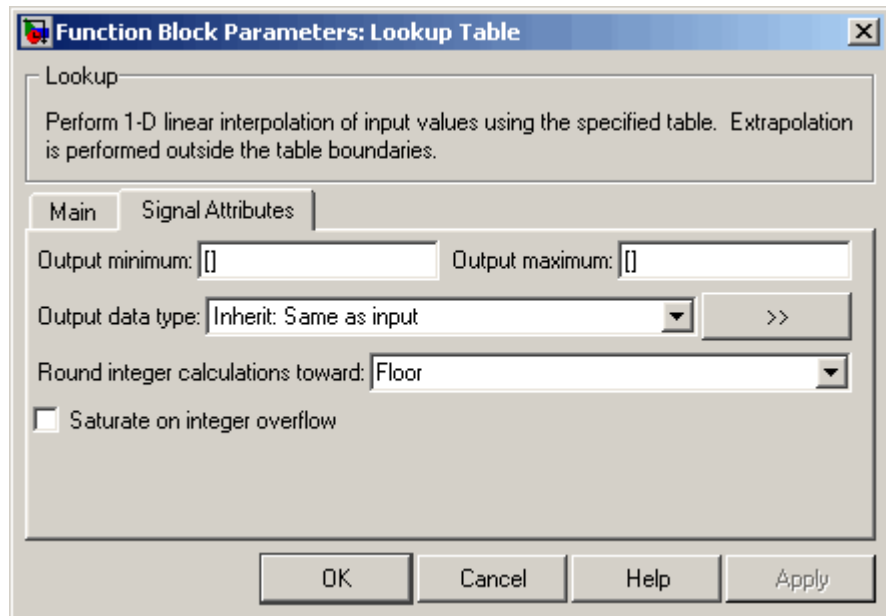

## Output minimum

Specify the minimum value that the block should output. The default value, [], is equivalent to  $-\text{Inf}$ . Simulink uses this value to perform:

- Parameter range checking (see “Checking Parameter Values”)
- Simulation range checking (see “Checking Signal Ranges”)
- Automatic scaling of fixed-point data types

## Output maximum

Specify the maximum value that the block should output. The default value, [], is equivalent to  $\text{Inf}$ . Simulink uses this value to perform:

- Parameter range checking (see “Checking Parameter Values”)
- Simulation range checking (see “Checking Signal Ranges”)

# Lookup Table

---

- Automatic scaling of fixed-point data types

## Output data type

Specify the output data type. You can set it to:

- A rule that inherits a data type, for example, `Inherit: Inherit via back propagation`
- The name of a built-in data type, for example, `single`
- The name of a data type object, for example, a `Simulink.NumericType` object
- An expression that evaluates to a data type, for example, `float('single')`

Click the **Show data type assistant** button  to display the **Data Type Assistant**, which helps you set the **Output data type** parameter.

See “Specifying Block Output Data Types” in *Using Simulink* for more information.

## Lock output scaling against changes by the autoscaling tool

Select to lock scaling of outputs. This parameter is visible only if you enter an expression for the **Output data type** parameter.

## Round integer calculations toward

Select the rounding mode for fixed-point lookup table calculations that occur during simulation or execution of code generated from the model.

Note that this option does not affect rounding of values of block parameters, such as **Table data**. Simulink rounds such values to the nearest representable integer value. To control the rounding of a block parameter, enter an expression using a MATLAB rounding function into the parameter’s edit field on the block dialog box.

## Saturate on integer overflow

Select to have overflows saturate.



## Examples

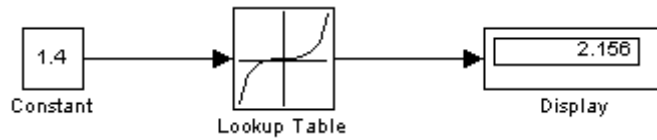

Suppose the Lookup Table block in the above model is configured to use a vector of input values given by  $[-5:5]$ , and table data given by  $\sinh([-5:5])$ . The following results are generated.

Lookup Method	Input	Output	Comment
Interpolation-Extrapolation	1.4	2.156	N/A
	5.2	83.59	N/A
Interpolation-Use End Values	1.4	2.156	N/A
	5.2	74.2	The value for $\sinh(5.0)$ was used.
Use Input Above	1.4	3.627	The value for $\sinh(2.0)$ was used.
	5.2	74.2	The value for $\sinh(5.0)$ was used.
Use Input Below	1.4	1.175	The value for $\sinh(1.0)$ was used.
	-5.2	-74.2	The value for $\sinh(-5.0)$ was used.
Use Input Nearest	1.4	1.175	The value for $\sinh(1.0)$ was used.

# Lookup Table

---

<b>Characteristics</b>	Direct Feedthrough	Yes
	Sample Time	Specified in the <b>Sample time</b> parameter
	Scalar Expansion	No
	Dimensionalized	Yes
	Zero Crossing	No

**See Also**      Lookup Table (2-D), Lookup Table (n-D)

## Purpose

Approximate two-dimensional function

## Library

Lookup Tables

## Description



The Lookup Table (2-D) block computes an approximation to some function  $z=f(x,y)$  given  $x$ ,  $y$ ,  $z$  data points. The first input port corresponds to the first table dimension,  $x$ . (See “Changing the Orientation of a Block” in Using Simulink for a description of the port order for various block orientations.)

The **Row index input values** parameter is a 1-by- $m$  vector of  $x$  data points, the **Column index input values** parameter is a 1-by- $n$  vector of  $y$  data points, and the **Table data** parameter is an  $m$ -by- $n$  matrix of  $z$  data points. Both the row and column vectors must be *monotonically increasing* (i.e., the value of the next element in the vector is greater than or equal to the value of the preceding element). However, these vectors must be *strictly monotonically increasing* (i.e., the value of the next element in the vector is greater than the value of the preceding element) in the following cases:

- The input and output data types are both fixed-point.
- The input and output data types are different.
- The lookup method is not Interpolation-Extrapolation.
- The matrix of output values is complex.
- Minimum, maximum, and overflow logging is on.

The block generates output based on the input values using one of these methods selected from the **Lookup method** parameter list:

- Interpolation-Extrapolation — This is the default method; it performs linear interpolation and extrapolation of the inputs.
  - If the inputs match row and column parameter values, the output is the value at the intersection of the row and column.

## Lookup Table (2-D)

---

- If the inputs do not match row and column parameter values, then the block generates output by linearly interpolating between the appropriate row and column values. If either or both block inputs are less than the first or greater than the last row or column values, the block extrapolates using the first two or last two points.

---

**Note** If the **Lookup method** parameter specifies Interpolation-Extrapolation, Real-Time Workshop can generate code for this block only if its input and output signals have the same floating-point data type.

---

- **Interpolation-Use End Values** — This method performs linear interpolation as described above but does not extrapolate outside the end points of x and y. Instead, the end-point values are used.
- **Use Input Nearest** — This method does not interpolate or extrapolate. Instead, the elements in x and y nearest the current inputs are found. The corresponding element in z is then used as the output.
- **Use Input Below** — This method does not interpolate or extrapolate. Instead, the elements in x and y nearest and below the current inputs are found. The corresponding element in z is then used as the output. If there are no elements in x or y below the current inputs, then the nearest elements are found.
- **Use Input Above** — This method does not interpolate or extrapolate. Instead, the elements in x and y nearest and above the current inputs are found. The corresponding element in z is then used as the output. If there are no elements in x or y above the current inputs, then the nearest elements are found.

---

**Note** Note that there is no difference among the Use Input Nearest, Use Input Below, and Use Input Above methods when the input  $x$  corresponds exactly to table breakpoints.

---

For information about creating a table with step transitions, see the Lookup Table block reference pages.

To avoid parameter saturation errors, the automatic scaling script `autofixexp` employs a special rule for the Lookup Table (2-D) block. `autofixexp` modifies the scaling by using the output lookup values in addition to the logged minimum and maximum simulation values. The output lookup values are converted to the specified output data type. This prevents the data from being saturated to different values.

### Data Type Support

The Lookup Table (2-D) block supports all data types supported by Simulink, including fixed-point data types.

For a discussion on the data types supported by Simulink, see “Data Types Supported by Simulink” in the Simulink documentation.

# Lookup Table (2-D)

## Parameters and Dialog Box

The **Main** pane of the Lookup Table (2-D) block dialog appears as follows:

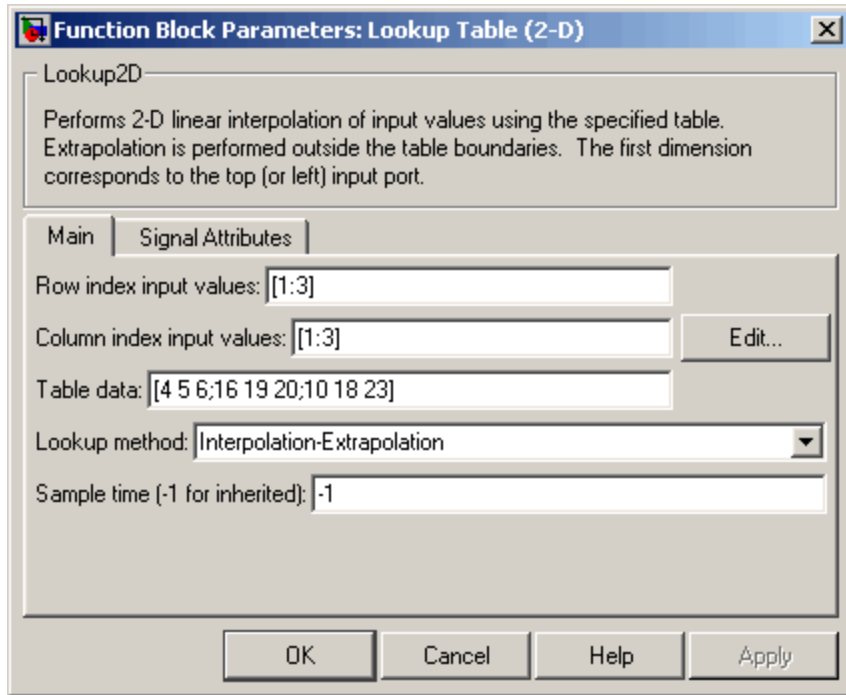

### Row index input values

The row values for the table, entered as a vector. The vector values must increase monotonically.

### Column index input values

The column values for the table, entered as a vector. The vector values must increase monotonically.

Click the **Edit** button to open the Lookup Table Editor (see “Lookup Table Editor” in the online Simulink documentation).

## Table data

The table of output values. The matrix size must match the dimensions defined by the **Row** and **Column** parameters.

## Lookup method

Specify the lookup method. See Description for a discussion of the options for this parameter.

## Sample time (-1 for inherited)

Specify the time interval between samples. To inherit the sample time, set this parameter to -1. See “Specifying Sample Time” in the online documentation for more information.

The **Signal Attributes** pane of the Lookup Table (2-D) block dialog appears as follows:

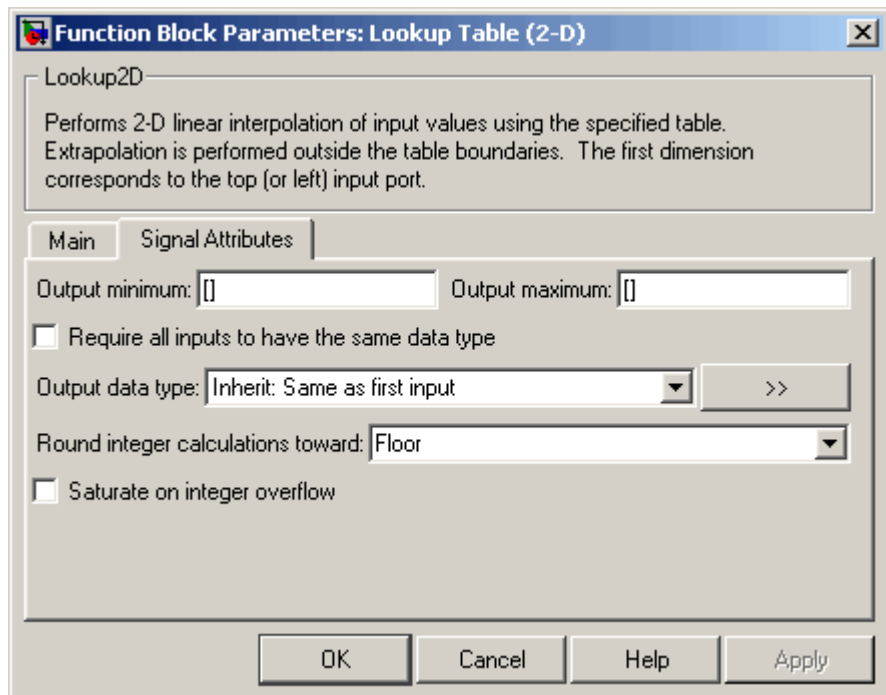

## Lookup Table (2-D)

---

### Output minimum

Specify the minimum value that the block should output. The default value, [], is equivalent to `-Inf`. Simulink uses this value to perform:

- Parameter range checking (see “Checking Parameter Values”)
- Simulation range checking (see “Checking Signal Ranges”)
- Automatic scaling of fixed-point data types

### Output maximum

Specify the maximum value that the block should output. The default value, [], is equivalent to `Inf`. Simulink uses this value to perform:

- Parameter range checking (see “Checking Parameter Values”)
- Simulation range checking (see “Checking Signal Ranges”)
- Automatic scaling of fixed-point data types

### Require all inputs to have the same data type

Select to require all inputs to have the same data type.

### Output data type

Specify the output data type. You can set it to:

- A rule that inherits a data type, for example, `Inherit: Inherit via back propagation`
- The name of a built-in data type, for example, `single`
- The name of a data type object, for example, a `Simulink.NumericType` object
- An expression that evaluates to a data type, for example, `float('single')`

Click the **Show data type assistant** button  to display the **Data Type Assistant**, which helps you set the **Output data type** parameter.



See “Specifying Block Output Data Types” in *Using Simulink* for more information.

### **Lock output scaling against changes by the autoscaling tool**

Select to lock scaling of outputs. This parameter is visible only if you enter an expression for the **Output data type** parameter.

### **Round integer calculations toward**

Select the rounding mode for fixed-point operations.

Note that block parameters such as **Table data** are always rounded to the nearest representable value. To control the rounding of a block parameter, enter an expression using a MATLAB rounding function into the mask field.

### **Saturate on integer overflow**

Select to have overflows saturate.

## **Examples**

In this example, the block parameters are defined as

```
Row index input values:    [1 2]
Column index input values: [3 4]
Table data:                [10 20; 30 40]
```

The first figure shows the block outputting a value at the intersection of block inputs that match row and column values. The first input is 1 and the second input is 4. These values select the table value at the intersection of the first row (row parameter value 1) and second column (column parameter value 4).

## Lookup Table (2-D)

	3	4
1	10	20
2	30	40

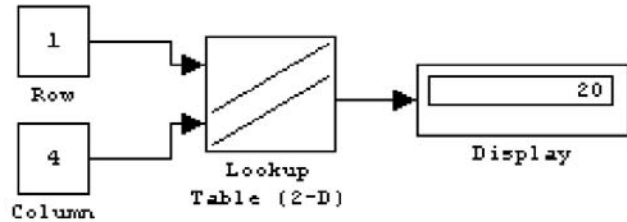

In the second figure, the first input is 1.7 and the second is 3.4. These values cause the block to interpolate between row and column values, as shown in the table at the left. The value at the intersection (28) is the output value.

	3	3.4	4
1	10	14	20
1.7	24	28	34
2	30	34	40

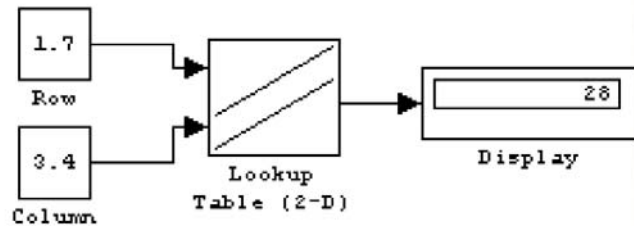

<b>Characteristics</b>	Direct Feedthrough	Yes
	Sample Time	Specified in the <b>Sample time</b> parameter
	Scalar Expansion	Yes, of one input if the other is a vector
	Dimensionalized	Yes
	Zero Crossing	No

**See Also**      Lookup Table, Lookup Table (n-D)

# Lookup Table (n-D)

**Purpose** Approximate N-dimensional function

**Library** Lookup Tables

## Description

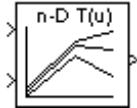

The Lookup Table (n-D) block evaluates a sampled representation of a function in N variables,  $y = F(x_1, x_2, x_3, \dots, x_n)$ , where the function  $F$  might be known only empirically. The block efficiently maps its inputs to an output value by looking up or interpolating a table of values as defined by the block's parameters. The block supports flat (constant), linear, and cubic spline interpolation methods. You can apply any of these methods to 1-D, 2-D, 3-D, or higher dimensional tables.

To use this block, specify the number of dimensions of your lookup table using the **Number of table dimensions** parameter. In the **Breakpoints for dimension** parameter, enter a breakpoint vector that corresponds to each dimension of your lookup table. Define the associated set of output values as the **Table data** parameter. You can customize the block's lookup and estimation behaviors by specifying, for example, values for its **Index search method**, **Interpolation method**, and **Extrapolation method** parameters.

The first block input identifies the first dimension (row) breakpoints, the next block input identifies the second dimension (column) breakpoints, and so on. See "Changing the Orientation of a Block" in *Using Simulink* for a description of the port order for various block orientations.

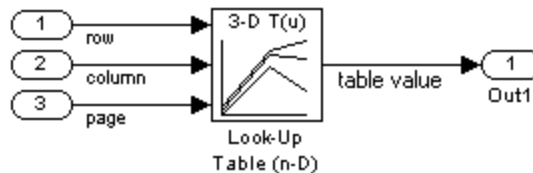

During simulation, the Lookup Table (n-D) block generates its output by looking up or estimating table values based on its input values:

- If the inputs match the values of indices specified in breakpoint vectors, the Lookup Table (n-D) block outputs the table value at the intersection of the row, column, and higher dimension breakpoints.
- If the inputs do not match the values of indices specified in breakpoint vectors, the Lookup Table (n-D) block generates output by interpolating appropriate table values. If the inputs are beyond the range of breakpoint vectors, the block can extrapolate its output values.

Alternatively, you can use the Interpolation Using Prelookup block with the Prelookup block to perform the equivalent operation of a Lookup Table (n-D) block. This combination of blocks offers greater flexibility that can result in more efficient simulation performance for linear interpolations in certain circumstances.

For noninterpolated table lookups, use the Direct Lookup Table (n-D) block when the lookup operation is a simple array access, for example, if you have an integer value  $k$  and you want the  $k$ th element of a table,  $y = table(k)$ .

## Data Type Support

The Lookup Table (n-D) block accepts signals of types `double` or `single`, but for any given Lookup Table (n-D) block, the inputs must all be of the same type. Table data and breakpoint vectors must be of the same type as the inputs. The output data type is set to the input data type.

# Lookup Table (n-D)

## Parameters and Dialog Box

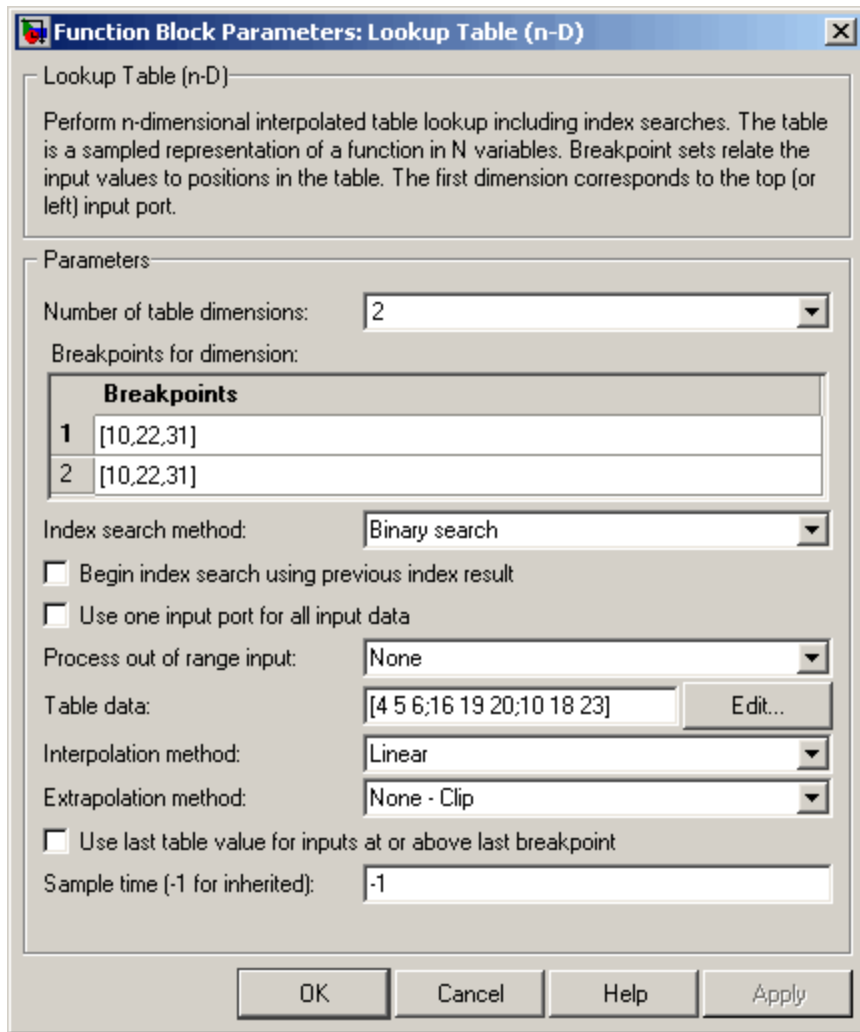

Function Block Parameters: Lookup Table (n-D)

Lookup Table (n-D)

Perform n-dimensional interpolated table lookup including index searches. The table is a sampled representation of a function in N variables. Breakpoint sets relate the input values to positions in the table. The first dimension corresponds to the top (or left) input port.

Parameters

Number of table dimensions: 2

Breakpoints for dimension:

Breakpoints	
1	[10,22,31]
2	[10,22,31]

Index search method: Binary search

Begin index search using previous index result

Use one input port for all input data

Process out of range input: None

Table data: [4 5 6;16 19 20;10 18 23] Edit...

Interpolation method: Linear

Extrapolation method: None - Clip

Use last table value for inputs at or above last breakpoint

Sample time (-1 for inherited): -1

OK Cancel Help Apply

### Number of table dimensions

Enter the number of dimensions of the **Table data** parameter by specifying an integer from 1 to 30. This determines the number of

independent variables for the table and hence the number of block inputs. It also determines the number of dimensions that appear in the **Breakpoints for dimension** parameter.

### **Breakpoints for dimension**

Define breakpoint sets that correspond to the dimensions of the **Table data** parameter. For each dimension, specify breakpoints as a vector whose values are strictly monotonically increasing.

### **Index search method**

Select Evenly spaced points, Linear search, or Binary search (the default). Each search method has speed advantages in different circumstances:

- If the breakpoint data is evenly spaced, e.g., 10, 20, 30, ..., you can achieve the greatest speed by selecting Evenly spaced points to calculate the table indices.
- For irregularly spaced breakpoint sets, if the input signals do not vary much from one time step to the next, selecting Linear search in combination with **Begin index search using previous index result** produces the best performance.
- For irregularly spaced breakpoint sets with rapidly varying input signals that jump more than one or two table intervals per time step, selecting Binary search produces the best performance.

A suboptimal choice of index search method can lead to slow performance of models that rely heavily on lookup tables.

---

**Note** The Evenly spaced points algorithm uses only the first two breakpoints to determine the offset and spacing of the remaining points.

---

# Lookup Table (n-D)

---

## **Begin index search using previous index result**

Select this option if you want the block to start its search using the index that was found at the previous time step. For inputs that change slowly with respect to the interval size, enabling this option can improve performance. Otherwise, the linear search and binary search methods might take significantly longer, especially for large breakpoint sets.

## **Use one input port for all input data**

Instead of having one input port per independent variable, the block is configured with just one input port that expects a signal that is N elements wide for an N-dimensional table. This might be useful in removing line clutter on a block diagram with many lookup tables.

## **Process out-of-range input**

Specifies whether to produce a warning or error message if the input is out of range. The options are:

- None — the default, no warning or error message
- Warning — display a warning message in the MATLAB Command Window and continue the simulation
- Error — halt the simulation and display an error message in the Simulation Diagnostics Viewer

## **Table data**

The table of output values. During simulation, the matrix size must match the dimensions defined by the **Number of table dimensions** parameter. However, during block diagram editing, you can enter either an empty matrix (specified as `[]`) or an undefined workspace variable as the **Table data** parameter. This technique allows you to postpone specifying a correctly dimensioned matrix for the **Table data** parameter and continue editing the block diagram. For information about how to construct multidimensional arrays in MATLAB, see “Multidimensional Arrays” in the MATLAB documentation.



Click the **Edit** button to open the Lookup Table Editor (see “Lookup Table Editor” in *Using Simulink* for more information).

### Interpolation method

Select None - Flat, Linear (the default), or Cubic spline. See “Interpolation Methods” in *Using Simulink* for more information.

### Extrapolation method

Select None - Clip, Linear (the default), or Cubic spline. See “Extrapolation Methods” in *Using Simulink* for more information.

### Use last table value for inputs at or above last breakpoint

Specify the indexing convention that the block uses internally to address the last element of a breakpoint vector and its corresponding table value. If selected, the block addresses the end of a breakpoint vector and its table value using the last element’s index and 0 for the interval fraction. Otherwise, the block addresses those same values using the index of the next-to-last breakpoint and 1 for the interval fraction.

This parameter is visible only if the **Interpolation method** specifies Linear and the **Extrapolation method** is None - Clip.

### Sample time (-1 for inherited)

Specify the time interval between samples. To inherit the sample time, set this parameter to -1. See “Specifying Sample Time” in *Using Simulink* for more information.

## Characteristics

Direct Feedthrough	Yes
Sample Time	Specified in the <b>Sample time</b> parameter
Scalar Expansion	No
Dimensionalized	No
Zero Crossing	No

## See Also

Lookup Table, Lookup Table (2-D), Lookup Table Dynamic

# Lookup Table Dynamic

---

**Purpose** Approximate one-dimensional function using dynamically specified table

**Library** Lookup Tables

**Description** The Lookup Table Dynamic block computes an approximation to some function  $y=f(x)$  given  $x$ ,  $y$  data vectors. The lookup method can use interpolation, extrapolation, or the original values of the input.

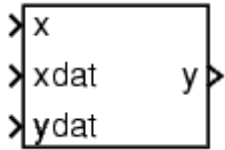

The  $x$  data vector must be *strictly monotonically increasing* (i.e., the value of the next element in the vector is greater than the value of the preceding element) after conversion to the input's fixed-point data type. Note that due to quantization, the  $x$  data vector may be strictly monotonic in doubles format, but not so after conversion to a fixed-point data type.

---

**Note** Unlike the Lookup Table block, the Lookup Table Dynamic block allows you to change the table data without stopping the simulation. For example, you may want to automatically incorporate new table data if the physical system you are simulating changes.

---

You define the lookup table by inputting the  $x$  and  $y$  table data to the block as 1-by- $n$  vectors. To help reduce the ROM used by the code generated for this block, you can use different data types for the  $x$  table data and the  $y$  table data. However, these restrictions apply:

- The  $y$  table data and the output vector must have the same sign, the same bias, and the same fractional slope.
- The  $x$  table data and the  $x$  data vector must have the same sign, the same bias, and the same fractional slope. Additionally, the precision and range for the  $x$  data vector must be greater than or equal to the precision and range for the  $x$  table data.

The block generates output based on the input values using one of these methods selected from the **Lookup Method** parameter list:

- **Interpolation-Extrapolation** — This is the default method; it performs linear interpolation and extrapolation of the inputs.
  - If a value matches the block's input, the output is the corresponding element in the output vector.
  - If no value matches the block's input, then the block performs linear interpolation between the two appropriate elements of the table to determine an output value. If the block input is less than the first or greater than the last input vector element, then the block extrapolates using the first two or last two points.

---

**Note** Real-Time Workshop cannot generate code for this block if its **Lookup Method** parameter specifies Interpolation-Extrapolation.

---

- **Interpolation-Use End Values** — This method performs linear interpolation as described above but does not extrapolate outside the end points of the input vector. Instead, the end-point values are used.
- **Use Input Nearest** — This method does not interpolate or extrapolate. Instead, the element in  $x$  nearest the current input is found. The corresponding element in  $y$  is then used as the output.
- **Use Input Below** — This method does not interpolate or extrapolate. Instead, the element in  $x$  nearest and below the current input is found. The corresponding element in  $y$  is then used as the output. If there is no element in  $x$  below the current input, then the nearest element is found.
- **Use Input Above** — This method does not interpolate or extrapolate. Instead, the element in  $x$  nearest and above the current input is found. The corresponding element in  $y$  is then used as the output. If there is no element in  $x$  above the current input, then the nearest element is found.

# Lookup Table Dynamic

---

**Note** Note that there is no difference among the Use Input Nearest, Use Input Below, and Use Input Above methods when the input  $x$  corresponds exactly to table breakpoints.

The table data is converted from doubles to the  $x$  data type offline using round-to-nearest and saturation.

## Data Type Support

The Lookup Table Dynamic block accepts signals of any data type supported by Simulink, including fixed-point data types.

## Parameters and Dialog Box

The **Main** pane of the Lookup Table Dynamic block dialog appears as follows:

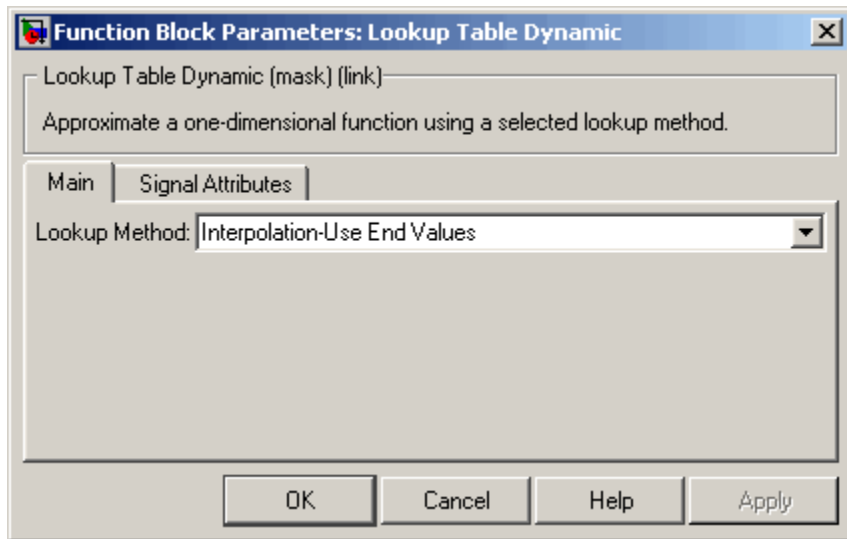

### Lookup Method

Specify the lookup method.

The **Signal Attributes** pane of the Lookup Table Dynamic block dialog appears as follows:

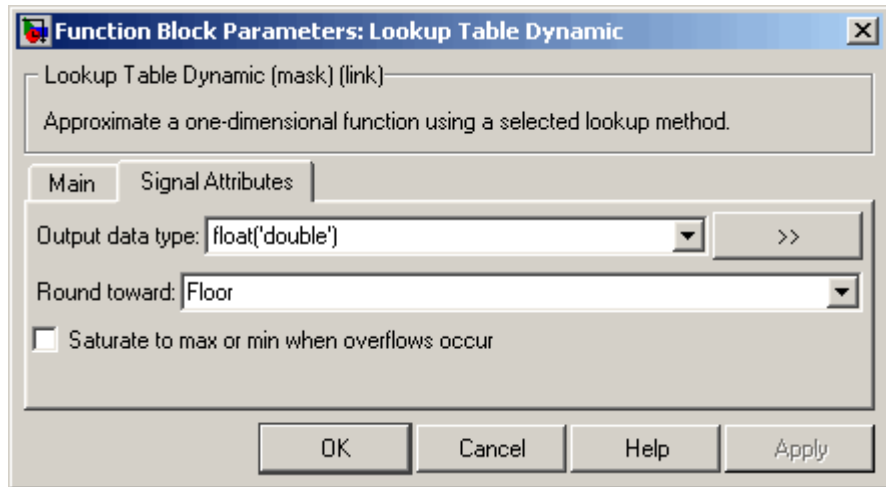

## Output data type

Specify the output data type. You can set it to:

- A rule that inherits a data type, for example, `Inherit: Inherit via back propagation`
- The name of a built-in data type, for example, `single`
- The name of a data type object, for example, a `Simulink.NumericType` object
- An expression that evaluates to a data type, for example, `float('single')`

Click the **Show data type assistant** button  to display the **Data Type Assistant**, which helps you set the **Output data type** parameter.

# Lookup Table Dynamic

---

See “Specifying Block Output Data Types” in *Using Simulink* for more information.

**Lock output scaling against changes by the autoscaling tool**

Select to lock scaling of outputs. This parameter is visible only if you enter an expression for the **Output data type** parameter.

**Round toward**

Rounding mode for the fixed-point output.

**Saturate to max or min when overflows occur**

If selected, fixed-point overflows saturate.

**Examples**

For an example that illustrates the lookup methods supported by this block, see the example included in the Lookup Table block reference pages.

**Characteristics**

Direct Feedthrough	Yes
Scalar Expansion	No

**See Also**

Lookup Table, Lookup Table (2-D), Lookup Table (n-D)

**Purpose** Convert magnitude and/or a phase angle signal to complex signal

**Library** Math Operations

## Description



The Magnitude-Angle to Complex block converts magnitude and/or phase angle inputs to a complex-valued output signal. The inputs must be real-valued signals of type `double` or `single`. The angle input is assumed to be in radians. The complex output signal has the same data type as the block inputs.

The inputs can both be signals of equal dimensions, or one input can be an array and the other a scalar. If the block has an array input, the output is an array of complex signals. The elements of a magnitude input vector are mapped to magnitudes of the corresponding complex output elements. An angle input vector is similarly mapped to the angles of the complex output signals. If one input is a scalar, it is mapped to the corresponding component (magnitude or angle) of all the complex output signals.

## Data Type Support

See the preceding block description.

# Magnitude-Angle to Complex

## Parameters and Dialog Box

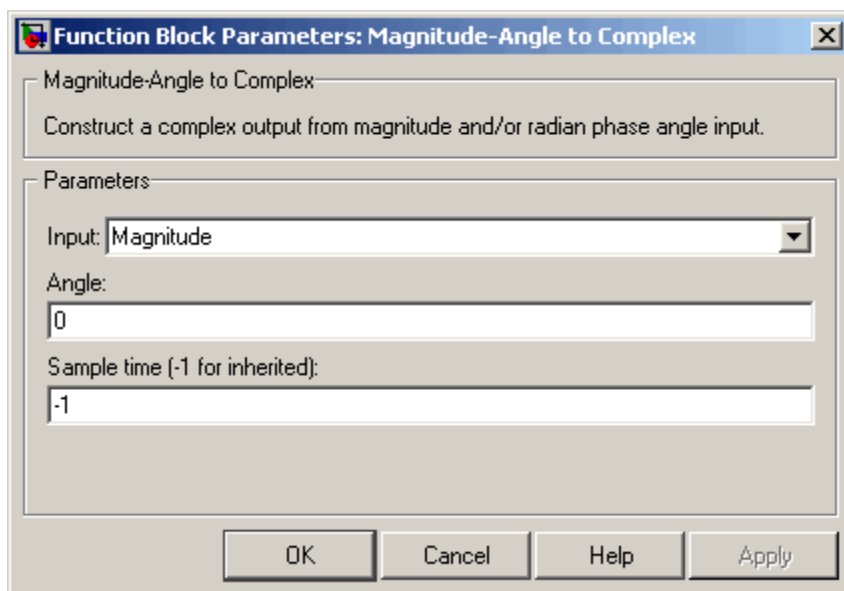

### Input

Specifies the kind of input: a magnitude input, an angle input, or both.

### Angle (Magnitude)

If the input is an angle signal, specifies the constant magnitude of the output signal. If the input is a magnitude, specifies the constant phase angle in radians of the output signal.

### Sample time (-1 for inherited)

Specify the time interval between samples. To inherit the sample time, set this parameter to -1. See “Specifying Sample Time” in the online documentation for more information.



# Magnitude-Angle to Complex

---

<b>Characteristics</b>	Direct Feedthrough	Yes
	Sample Time	Inherited from driving block
	Scalar Expansion	Yes, of the input when the function requires two inputs
	Dimensionalized	Yes
	Multidimensionalized	Yes
	Zero Crossing	No

# Manual Switch

---

**Purpose** Switch between two inputs

**Library** Signal Routing

## Description

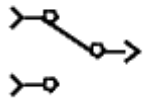

The Manual Switch block is a toggle switch that selects one of its two inputs to pass through to the output. To toggle between inputs, double-click the block (there is no dialog box). The selected input is propagated to the output, while the unselected input is discarded. You can set the switch before the simulation is started or throw it while the simulation is executing to interactively control the signal flow. The Manual Switch block retains its current state when the model is saved.

## Data Type Support

The Manual Switch block accepts real or complex signals of any data type supported by Simulink, including fixed-point data types.

For a discussion on the data types supported by Simulink, see “Data Types Supported by Simulink” in the Simulink documentation.

**Parameters and Dialog Box** None

## Characteristics

Direct Feedthrough	Yes
Sample Time	Inherited from driving block
Scalar Expansion	N/A
Dimensionalized	Yes
Multidimensionalized	Yes
Zero Crossing	No

**Purpose** Perform mathematical function

**Library** Math Operations

**Description** The Math Function block performs numerous common mathematical functions.

You can select one of the following functions from the **Function** parameter list.

Function	Description	Mathematical Expression	Equivalent in MATLAB
exp	Exponential	$e^u$	exp
log	Natural logarithm	$\ln u$	log
10^u	Array power of base 10	$10^u$	10.^u (see power)
log10	Common (base 10) logarithm	$\log u$	log10
magnitude^2	Complex modulus	$ u ^2$	(abs(u)).^2 (see abs and power)
square	Array power 2	$u^2$	u.^2 (see power)
sqrt	Square root	$u^{0.5}$	sqrt
pow	Array power	$u^v$	power
conj	Complex conjugate	$\bar{u}$	conj
reciprocal	Array reciprocal	$1/u$	1./u (see rdivide)
hypot	Square root of sum squares	$(u^2+v^2)^{0.5}$	hypot
rem	Remainder after division	—	rem

# Math Function

Function	Description	Mathematical Expression	Equivalent in MATLAB
mod	Modulus after division	—	mod
transpose	Array transpose	$u^T$	u.' (see arithmetic operators)
hermitian	Complex conjugate transpose	$u^H$	u' (see arithmetic operators)

The block output is the result of the operation of the function on the input or inputs.

The name of the function appears on the block. Simulink automatically draws the appropriate number of input ports.

Use the Math Function block instead of the Fcn block when you want vector or matrix output, because the Fcn block produces only scalar output.

## Data Type Support

The following table shows which input data types are supported by each of the functions of the Math Function block.

Function	single	double	built-in integer	fixed point
exp	yes	yes	—	—
log	yes	yes	—	—
$10^u$	yes	yes	—	—
log10	yes	yes	—	—
magnitude <sup>2</sup>	yes	yes	yes	yes
square	yes	yes	yes	yes
sqrt	yes	yes	yes	yes

Function	single	double	built-in integer	fixed point
pow	yes	yes	—	—
conj	yes	yes	yes	yes
reciprocal	yes	yes	yes	yes
hypot	yes	yes	—	—
rem	yes	yes	yes	—
mod	yes	yes	yes	—
transpose	yes	yes	yes	yes
hermitian	yes	yes	yes	yes

All supported modes accept both real and complex inputs, except for reciprocal and sqrt, which do not accept complex fixed-point inputs. Also, sqrt does not accept fixed-point inputs that are negative or that have nontrivial slope and nonzero bias. The output signal type of the block is real or complex, depending on the setting of the **Output signal type** parameter.

# Math Function

## Parameters and Dialog Box

The **Main** pane of the Math Function block dialog appears as follows:

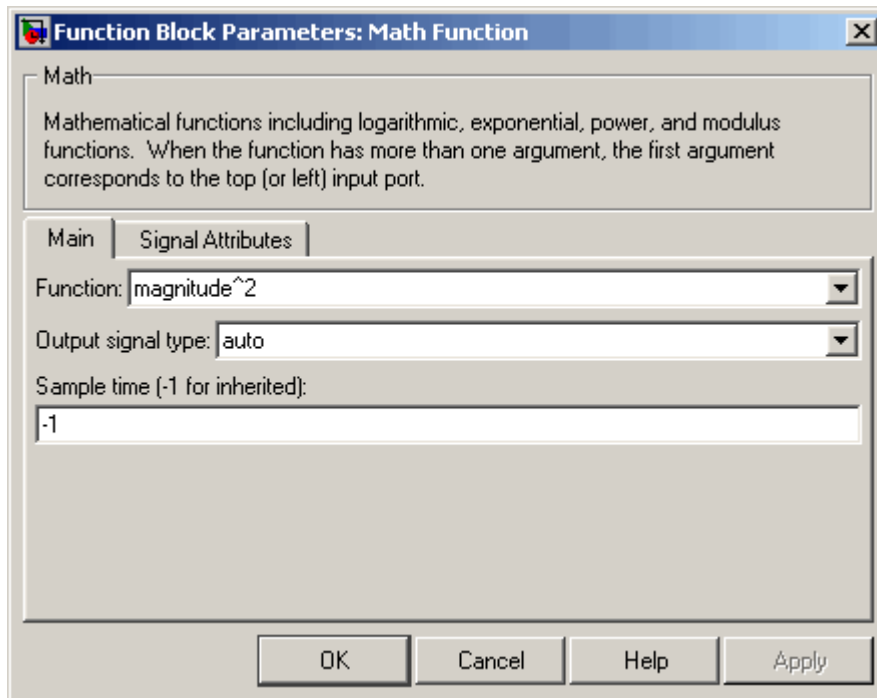

### Function

Specify the mathematical function. See Description for more information about the options for this parameter.

### Output signal type

Select the output signal type of the Math Function block as real, complex, or auto.

Function	Input	Output Signal Type		
	Signal	Auto	Real	Complex
exp, log, 10u, log10, square, sqrt, pow, reciprocal, conjugate, transpose, hermitian	real	real	real	complex
	complex	complex	error	complex
magnitude squared	real	real	real	complex
	complex	real	real	complex
hypot, rem, mod	real	real	real	complex
	complex	error	error	error

### Sample time (-1 for inherited)

Specify the time interval between samples. To inherit the sample time, set this parameter to -1. See “Specifying Sample Time” in the online documentation for more information.

The **Signal Attributes** pane of the Math Function block dialog appears as follows:

# Math Function

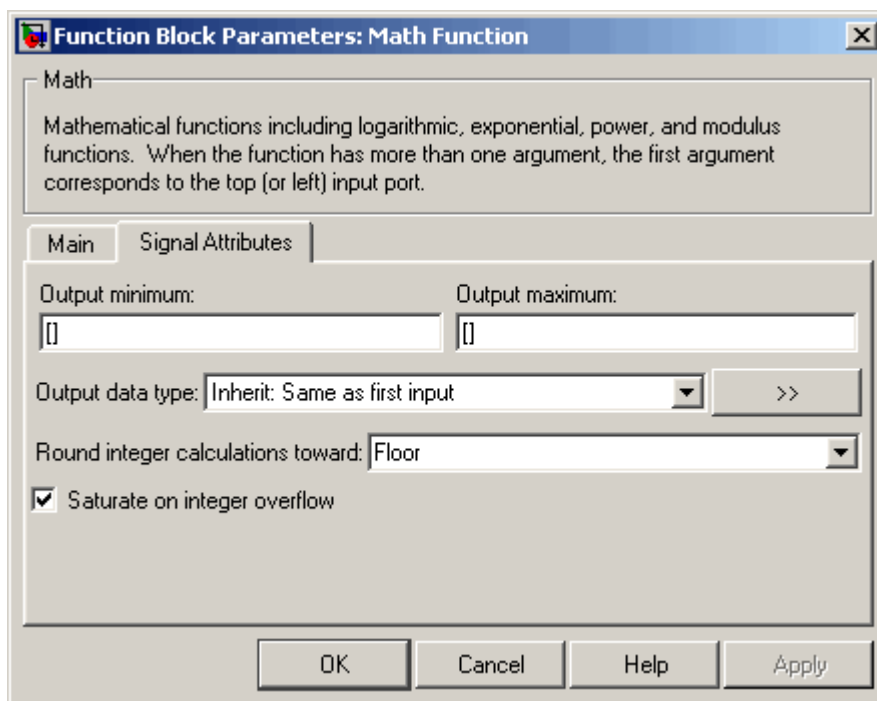

---

**Note** Some of the parameters on this pane are available only when the function chosen in the **Function** parameter supports fixed-point data types.

---

## Output minimum

Specify the minimum value that the block should output. The default value, [], is equivalent to  $-\text{Inf}$ . Simulink uses this value to perform:

- Simulation range checking (see “Checking Signal Ranges”)
- Automatic scaling of fixed-point data types



## Output maximum

Specify the maximum value that the block should output. The default value, [], is equivalent to Inf. Simulink uses this value to perform:

- Simulation range checking (see “Checking Signal Ranges”)
- Automatic scaling of fixed-point data types

## Output data type

Specify the output data type. You can set it to:

- A rule that inherits a data type, for example, Inherit: Inherit via back propagation
- The name of a built-in data type, for example, single
- The name of a data type object, for example, a Simulink.NumericType object
- An expression that evaluates to a data type, for example, float('single')

Click the **Show data type assistant** button  to display the **Data Type Assistant**, which helps you set the **Output data type** parameter.

See “Specifying Block Output Data Types” in *Using Simulink* for more information.

## Lock output scaling against changes by the autoscaling tool

Select to lock scaling of outputs. This parameter is visible only if you enter an expression for the **Output data type** parameter.

## Round integer calculations toward

Select the rounding mode for fixed-point operations.

## Saturate on integer overflow

If selected, fixed-point overflows saturate.

# Math Function

---

<b>Characteristics</b>		
Direct Feedthrough		Yes
Sample Time		Specified in the <b>Sample time</b> parameter
Scalar Expansion		Yes, of the input when the function requires two inputs
Dimensionalized		Yes
Multidimensionalized		Yes, for all functions except hermitian and transpose
Zero Crossing		No

## Purpose

Apply MATLAB function or expression to input

## Library

User-Defined Functions

## Description

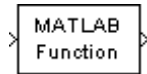

The MATLAB Fcn block applies the specified MATLAB function or expression to the input. The output of the function must match the output dimensions of the block or an error occurs.

Here are some sample valid expressions for this block.

```
sin
atan2(u(1), u(2))
u(1)^u(2)
```

---

**Note** This block is slower than the Fcn block because it calls the MATLAB parser during each integration step. Consider using built-in blocks (such as the Fcn block or the Math Function block) instead, or writing the function as an M-file or MEX-file S-function, then accessing it using the S-Function block.

---

## Data Type Support

The MATLAB Fcn block accepts one complex or real input of type `double` and generates real or complex output of type `double`, depending on the setting of the **Output signal type** parameter.

## Parameters and Dialog Box

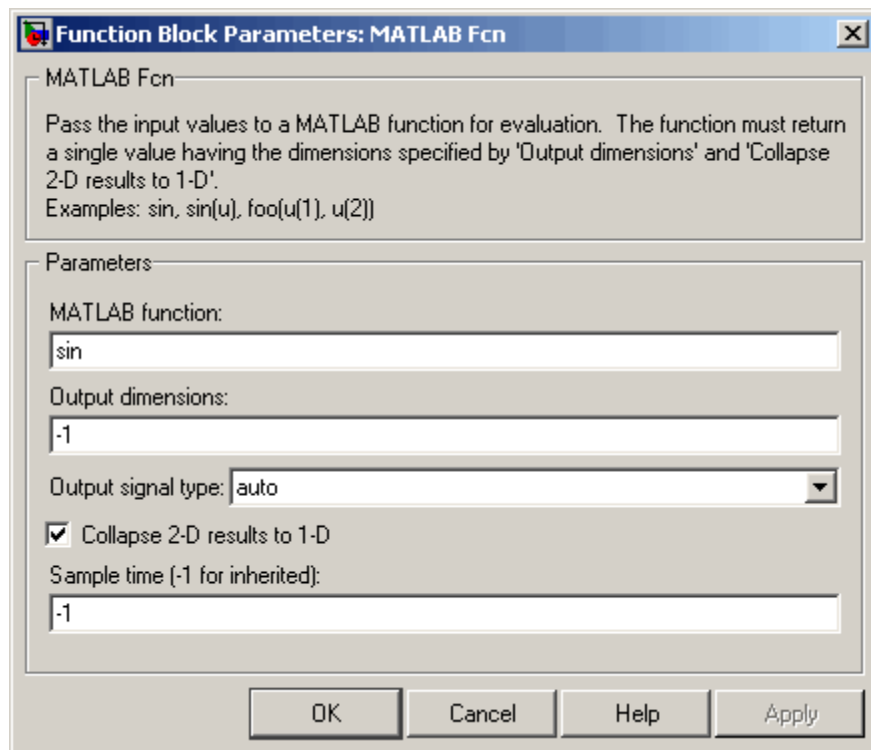

### MATLAB function

The function or expression. If you specify a function only, it is not necessary to include the input argument in parentheses.

### Output dimensions

Dimensions of the signal output by this block. If the output dimensions are to be the same as the dimensions of the input signal, specify -1. Otherwise, enter the dimensions of the output signal, e.g., 2 for a two-element vector. In either case, the output dimensions must match the dimensions of the value returned by the function or expression in the **MATLAB function** field.

## Output signal type

The dialog allows you to select the output signal type of the MATLAB Fcn as real, complex, or auto. A value of auto sets the block's output type to be the same as the type of the input signal.

## Collapse 2-D results to 1-D

Outputs a 2-D array as a 1-D array containing the 2-D array's elements in column-major order.

## Sample time (-1 for inherited)

Specify the time interval between samples. To inherit the sample time, set this parameter to -1. See "Specifying Sample Time" in the online documentation for more information.

## Characteristics

Direct Feedthrough	Yes
Sample Time	Inherited from driving block
Scalar Expansion	N/A
Dimensionalized	Yes
Zero Crossing	No

# Matrix Concatenate, Vector Concatenate

---

**Purpose** Concatenate input signals of same data type to create contiguous output signal

**Library** Math Operations

## Description



The Concatenate block concatenates the signals at its inputs to create an output signal whose elements reside in contiguous locations in memory. This block operates in either vector or multidimensional array concatenation mode, depending on the setting of its **Mode** parameter. In either case, the inputs are concatenated from the top to bottom, or left to right, input ports.

### Vector Mode

In vector mode, all input signals must be either vectors or row vectors [ $1 \times M$  matrices] or column vectors [ $M \times 1$  matrices] or a combination of vectors and either row or column vectors. The output is a vector if all inputs are vectors.

The output is a row or column vector if any of the inputs are row or column vectors, respectively.

### Multidimensional Array Mode

Multidimensional array mode accepts vectors and arrays of any size. It assumes that the trailing dimensions are all ones for input signals with lower dimensionality. For example, if the output is 4-D and the input is  $[2 \times 3]$  (2-D) this block treats the input as  $[2 \times 3 \times 1 \times 1]$ . The output is always an array. The block's **Concatenate dimension** parameter allows you to specify the output dimension along which the block concatenates its input arrays. If you set the **Concatenate dimension** parameter to 2 and inputs are 2-D matrices, the block performs horizontal matrix concatenation and places the input matrices side-by-side to create the output matrix, e.g.,

# Matrix Concatenate, Vector Concatenate

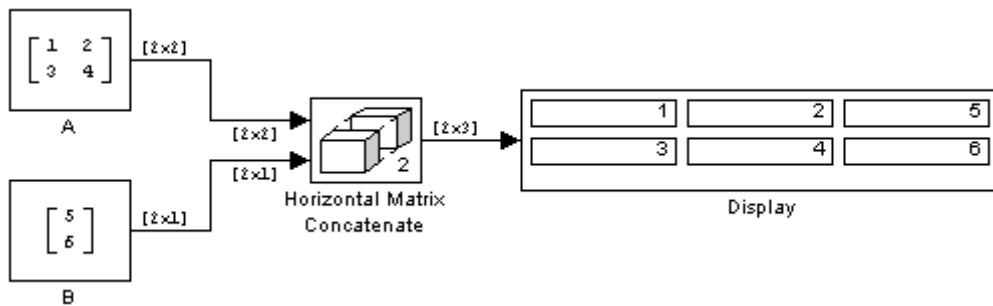

If you set the **Concatenate dimension** parameter to 1 and inputs are 2-D matrices, the block performs vertical matrix concatenation and stacks the input matrices on top of each other to create the output matrix, e.g.,

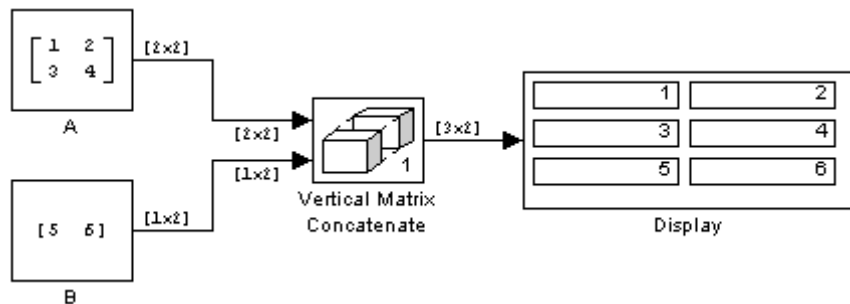

For horizontal concatenation, the input matrices must have the same column dimension; for vertical concatenation, the same row dimension. All input signals must have the same dimension for all dimensions other than the concatenation dimensions.

If you set the **Mode** parameter to Multidimensional array, the **Concatenate dimension** parameter to 3, and the inputs are 2-D matrices, the block performs multidimensional matrix concatenation, e.g.,

# Matrix Concatenate, Vector Concatenate

---

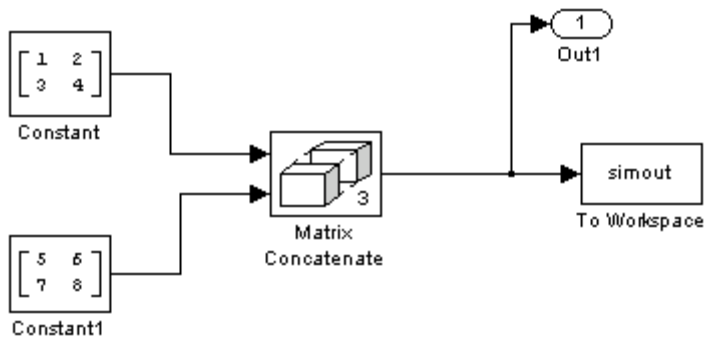

## Data Type Support

Accepts signals of any data type supported by Simulink. All inputs must be of the same data type. Outputs the same data type as the input.

For a discussion on the data types supported by Simulink, see “Data Types Supported by Simulink” in the “Working with Data” chapter of the Using Simulink documentation.



# Matrix Concatenate, Vector Concatenate

## Parameters and Dialog Box

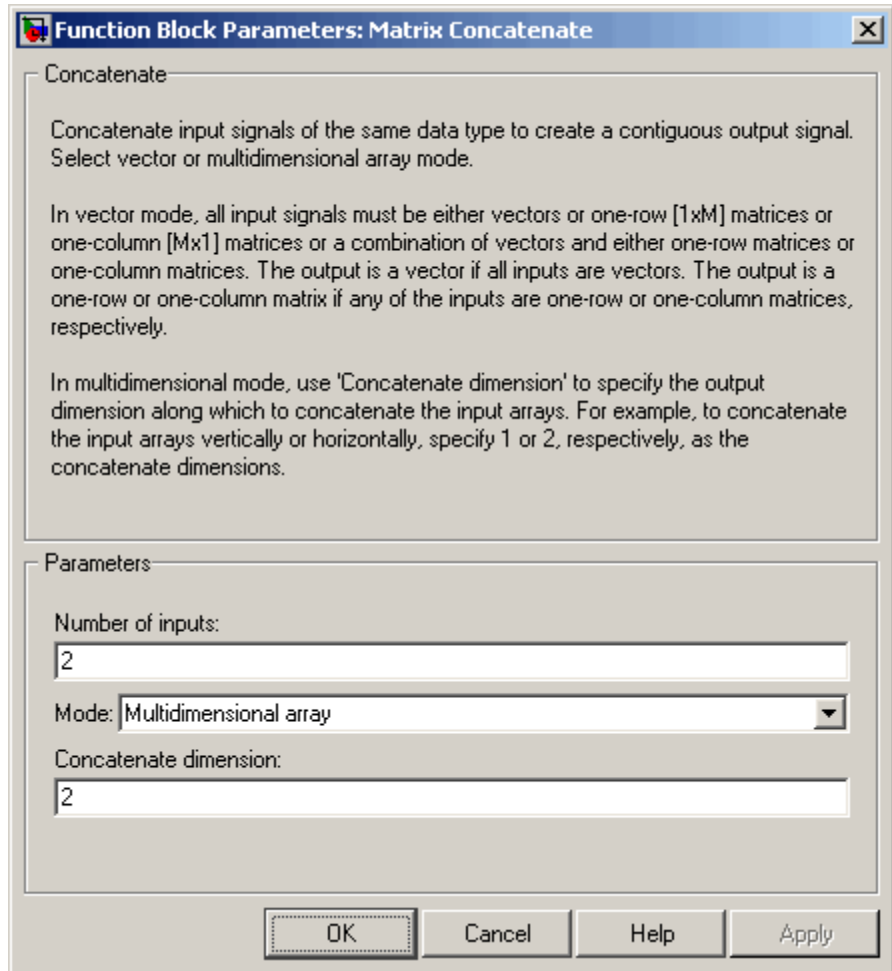

### Number of inputs

Number of inputs on this block.

### Mode

Specifies the type of concatenation performed by this block.

Options are:

# Matrix Concatenate, Vector Concatenate

---

- Vector (see “Vector Mode” on page 2-448)
- Multidimensional array (see “Multidimensional Array Mode” on page 2-448)

## Concatenate dimension

Specifies the output dimension along which to concatenate the input arrays. For example, to concatenate the input arrays vertically or horizontally, specify 1 or 2, respectively. This option appears only if you select Multidimensional array for the **Mode** parameter.

## Characteristics

Direct Feedthrough	Yes
Sample Time	Inherited from driving block
Scalar Expansion	No
Dimensionalized	Yes
Multidimensionalized	Yes
Zero Crossing	No

## See Also

cat in the MATLAB reference documentation

**Purpose** Output input from previous time step

**Library** Discrete

## Description

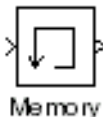

The Memory block outputs its input from the previous time step, applying a one integration step sample-and-hold to its input signal.

This sample model demonstrates how to display the step size used in a simulation. The Sum block subtracts the time at the previous step, generated by the Memory block, from the current time, generated by the clock.

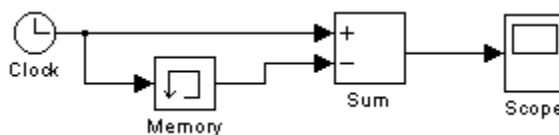

---

**Note** Avoid using the Memory block when integrating with ode15s or ode113, unless the input to the block does not change.

---

## Data Type Support

The Memory block accepts real or complex signals of any data type supported by Simulink, including fixed-point data types.

For a discussion on the data types supported by Simulink, see “Data Types Supported by Simulink” in the Simulink documentation.

## Parameters and Dialog Box

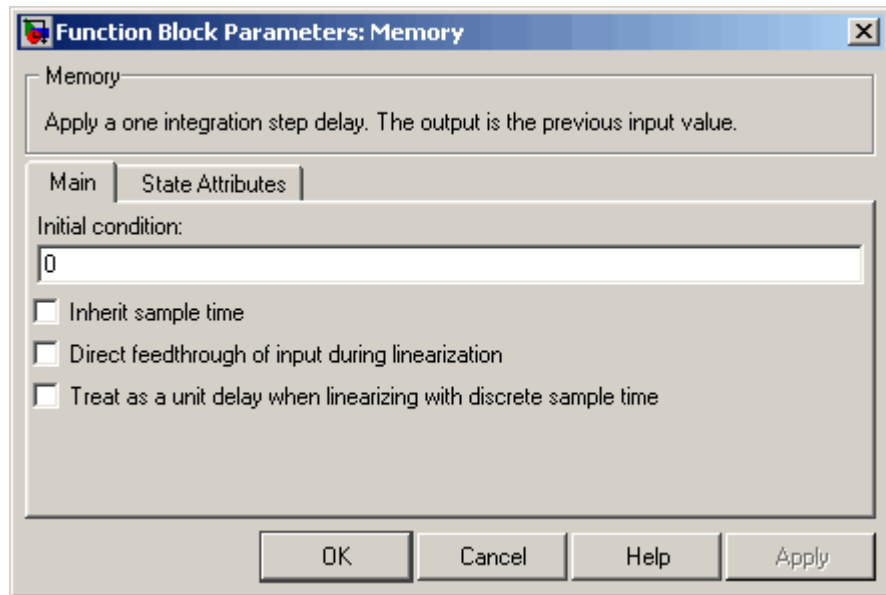

### Initial condition

The output at the initial integration step. This must be set to 0 if the input data type is user-defined. Simulink does not allow the initial output of this block to be `inf` or `NaN`.

### Inherit sample time

Check this check box to cause the sample time to be inherited from the driving block. If this option is not selected, the block's sample time depends on the type of solver used to simulate the model. If the solver is a variable-step solver, the sample time is continuous but fixed in minor time step (`[0, 1]`). If the solver is a fixed-step solver, this `[0, 1]` sample time is converted to the solver's step size after sample time propagation.

### Direct feedthrough of input during linearization

Causes the block to output its input during linearization and trim. This sets the block's mode to direct feedthrough.

Enabling this check box can cause a change in the ordering of states in the model when using the functions `linmod`, `dlinmod`, or `trim`. To extract this new state ordering, use the following commands.

First compile the model using the following command, where `model` is the name of the Simulink model.

```
[sizes, x0, x_str] = model([],[],[],'lincompile');
```

Next, terminate the compilation with the following command.

```
model([],[],[],'term');
```

The output argument, `x_str`, which is a cell array of the states in the Simulink model, contains the new state ordering. When passing a vector of states as input to the `linmod`, `dlinmod`, or `trim` functions, the state vector must use this new state ordering.

### **Treat as a unit delay when linearizing with discrete sample time**

Select this check box to linearize the Memory block to a unit delay when the Memory block is driven by a signal with a discrete sample time.

The **State Attributes** pane of this block pertains to code generation and has no effect on model simulation. See “Block State Storage and Interfacing” in the Real-Time Workshop documentation for more information.

## **Bus Support**

The Memory block is a bus-capable block. The input can be a virtual or nonvirtual bus signal subject to the following restrictions:

- **Initial condition** must be zero or a non-zero scalar.
- If **Initial condition** is zero and a **State name** is specified, the input cannot be a virtual bus.
- If **Initial condition** is a non-zero scalar, no **State name** can be specified.

# Memory

---

<b>Characteristics</b>		
Bus-capable		Yes, with restrictions as noted above
Direct Feedthrough		No, except when <b>Direct feedthrough of input during linearization is enabled</b>
Sample Time		Continuous, but inherited from the driving block if you select the <b>Inherit sample time</b> check box
Scalar Expansion		Yes, of the <b>Initial condition</b> parameter
Dimensionalized		Yes
Multidimensionalized		Yes
Zero Crossing		No

**Purpose** Combine multiple signals into single signal

**Library** Signal Routing

**Description**

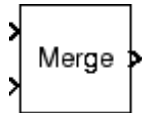

The Merge block combines its inputs into a single output line whose value at any time is equal to the most recently computed output of its driving blocks. You can specify any number of inputs by setting the block's **Number of inputs** parameter.

---

**Note** Merge blocks assume that all driving signals share the same signal memory. The shared signal memory should be accessed only in mutually exclusive fashion. Therefore, always use alternately executing subsystems to drive Merge blocks. See “Creating Alternately Executing Subsystems” for an application example.

---

A Merge block does not accept signals whose elements have been reordered or partially selected. For example, in the following diagram, the Merge block does not accept the output of the first Selector block because the Selector block interchanges the first and last elements of the vector signal. It does not accept the output of the second Selector block because the Selector block selects only the first three elements.

# Merge

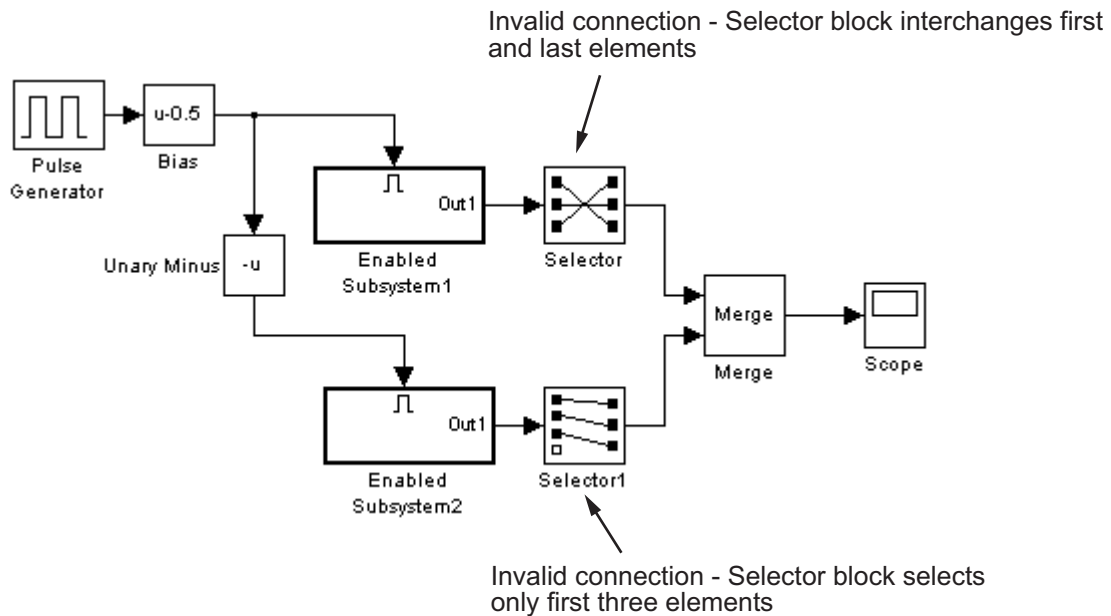

If the **Allow unequal port widths** parameter is not selected, the block accepts only inputs of equal dimensions and outputs a signal of the same dimensions as the inputs. If you select the **Allow unequal port widths** option, the block accepts scalars and vectors (but not matrices) having differing numbers of elements. Further, the block allows you to specify an offset for each input signal relative to the beginning of the output signal. The width of the output signal is

$$\max(w_1+o_1, w_2+o_2, \dots, w_n+o_n)$$



where  $w_1, \dots, w_n$  are the widths of the input signals and  $o_1, \dots, o_n$  are the offsets for the input signals. For example, the Merge block in the following diagram has a Merge block width of

$$\max(2+0, 2+1)=3$$

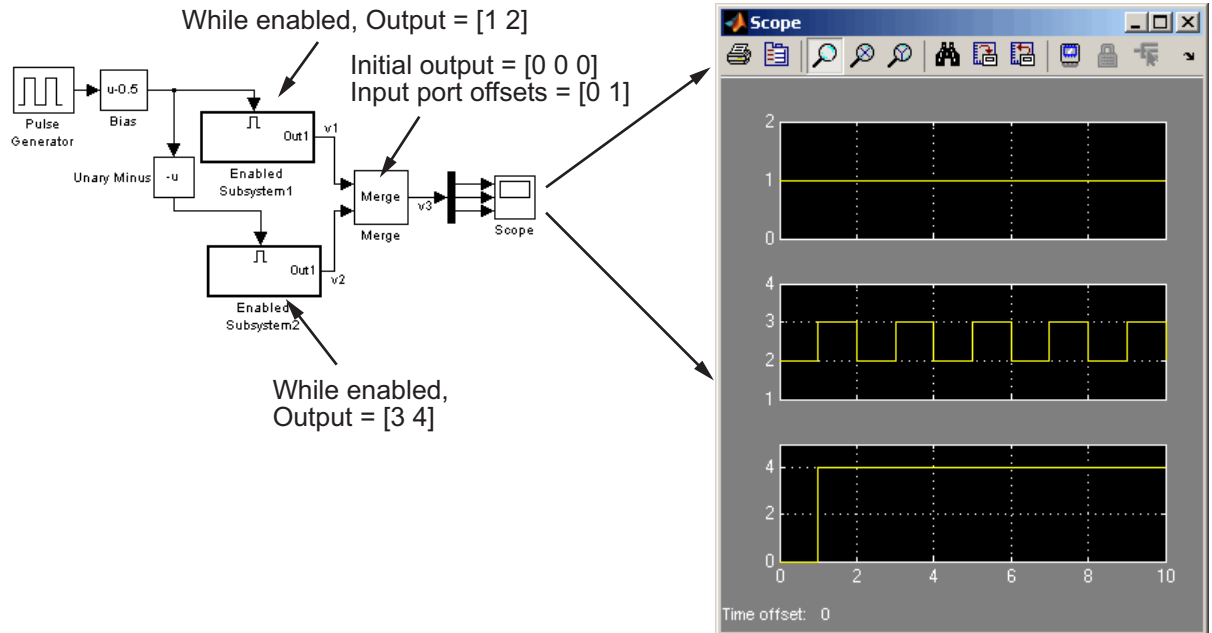

In this example, the offset of  $v_1$  is 0 and the offset of  $v_2$  is 1. The Merge block maps the elements of  $v_1$  to the first two elements of  $v_3$  and the elements of  $v_2$  to the last two elements of  $v_3$ . Only the second element of  $v_3$  is effectively merged, as seen from the scopes output.

You can specify an initial output value by setting the block's **Initial output** parameter. If you do not specify an initial output and one or more of the driving blocks do, the Merge block's initial output equals the most recently evaluated initial output of the driving blocks.

## Merging S-Function Outputs

The Merge block can merge a signal from an S-Function block only if the memory used to store the S-Function block's output is reusable. Simulink displays an error message if you attempt to update or simulate a model that connects a nonreusable port of an S-Function block to a Merge block. See `ssSetOutputPortOptimOpts` for more information.

## Guidelines for Using Merge Block

When using the Merge block, consider the following:

- Do not connect an input of a Merge block to any other block. Doing so causes an error.
- Always use conditionally executed subsystems to drive Merge blocks.
- Always set the **Initial output** parameter of the Merge block.
- Write your control logic to ensure that at most one of the driving conditionally executed subsystems executes at any time step.

---

**Note** Where possible, use the If or Switch Case block to provide control logic.

---

- For all conditionally executed subsystem Output blocks that drive Merge blocks:
  - Set the **Initial output** parameter to empty matrix (`[]`).
  - Set the **Output when disabled** parameter to held.

## Data Type Support

The Merge block accepts real or complex signals of any data type supported by Simulink, including fixed-point data types.

For a discussion on the data types supported by Simulink, see “Data Types Supported by Simulink” in the Simulink documentation.

## Parameters and Dialog Box

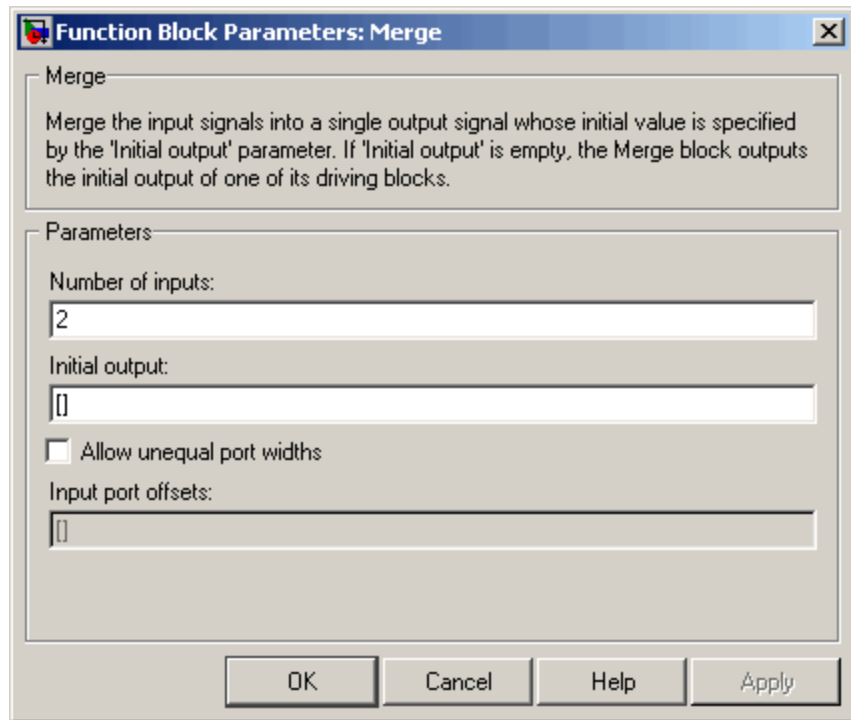

### Number of inputs

The number of input ports to merge.

### Initial output

Initial value of output. If unspecified, the initial output equals the initial output, if any, of one of the driving blocks. Simulink does not allow you to set the initial output of this block to `inf` or `NaN`.

### Allow unequal port widths

Allows the block to accept inputs having different numbers of elements.

### Input port offsets

Vector specifying the offset of each input signal relative to the beginning of the output signal.

# Merge

---

## Bus Support

The Merge block is a bus-capable block. The inputs can be virtual or nonvirtual bus signals subject to the following restrictions:

- The number of inputs must be greater than one.
- **Initial output** must be zero or a non-zero scalar.
- **Allow unequal port widths** must be disabled.
- All inputs to the merge must be buses and must be equivalent (same hierarchy with identical names and attributes for all elements).

## Characteristics

Bus-capable	Yes, with restrictions as noted above
Direct Feedthrough	Yes
Sample Time	Inherited from the driving block
Scalar Expansion	No
Dimensionalized	Yes
Multidimensionalized	Yes
Zero Crossing	No

**Purpose** Output minimum or maximum input value

**Library** Math Operations

### Description



The MinMax block outputs either the minimum or the maximum element or elements of the inputs. You can choose the function to apply by selecting one of the choices from the **Function** parameter list.

If the block has one input port, the input must be a scalar or a vector. The block outputs a scalar equal to the minimum or maximum element of the input vector.

If the block has multiple input ports, the nonscalar inputs must all have the same dimensions. The block expands any scalar inputs to have the same dimensions as the nonscalar inputs. The block outputs a signal having the same dimensions as the input. Each output element equals the minimum or maximum of the corresponding input elements.

### Data Type Support

The MinMax block accepts and outputs real signals of any data type supported by Simulink, except Boolean. The MinMax block supports fixed-point data types.

For a discussion on the data types supported by Simulink, see “Data Types Supported by Simulink” in the Simulink documentation.

# MinMax

## Parameters and Dialog Box

The **Main** pane of the MinMax block dialog appears as follows:

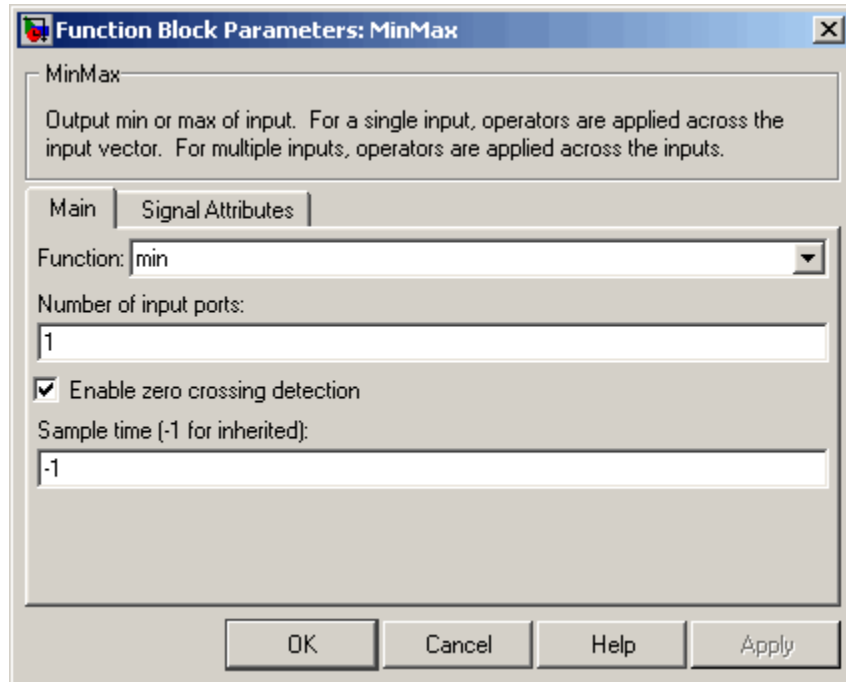

### Function

Specify whether to apply the function min or max to the input.

### Number of input ports

Specify the number of inputs to the block.

### Enable zero crossing detection

Select to enable zero crossing detection to detect minimum and maximum values. For more information, see “Zero-Crossing Detection” in the “How Simulink Works” chapter of the Using Simulink documentation.

## Sample time (-1 for inherited)

Specify the time interval between samples. To inherit the sample time, set this parameter to -1. See “Specifying Sample Time” in the online documentation for more information.

The **Signal Attributes** pane of the MinMax block dialog appears as follows:

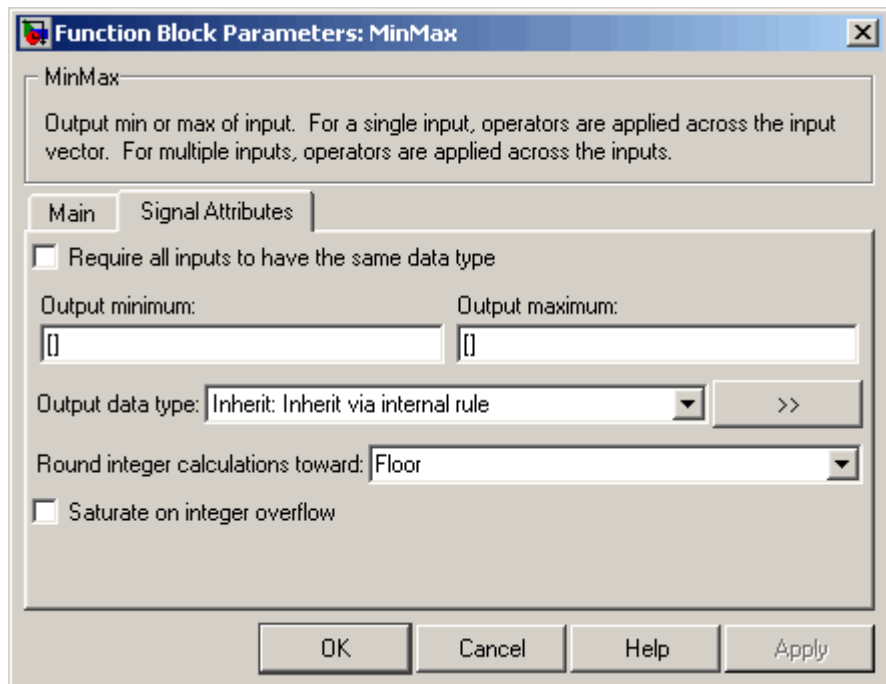

## Require all inputs to have the same data type

Select this parameter to require that all inputs must have the same data type.

## Output minimum

Specify the minimum value that the block should output. The default value, [], is equivalent to `-Inf`. Simulink uses this value to perform:

- Simulation range checking (see “Checking Signal Ranges”)
- Automatic scaling of fixed-point data types

## Output maximum

Specify the maximum value that the block should output. The default value, [], is equivalent to `Inf`. Simulink uses this value to perform:

- Simulation range checking (see “Checking Signal Ranges”)
- Automatic scaling of fixed-point data types

## Output data type

Specify the output data type. You can set it to:

- A rule that inherits a data type, for example, `Inherit: Inherit via back propagation`
- The name of a built-in data type, for example, `single`
- The name of a data type object, for example, a `Simulink.NumericType` object
- An expression that evaluates to a data type, for example, `float('single')`

Click the **Show data type assistant** button  to display the **Data Type Assistant**, which helps you set the **Output data type** parameter.

See “Specifying Block Output Data Types” in *Using Simulink* for more information.

## Lock output scaling against changes by the autoscaling tool

Select to lock scaling of outputs. This parameter is visible only if you enter an expression for the **Output data type** parameter.



**Round integer calculations toward**

Select the rounding mode for fixed-point operations.

**Saturate on integer overflow**

Select to have overflows saturate.

**Characteristics**

Direct Feedthrough	Yes
Sample Time	Specified in the <b>Sample time</b> parameter
Scalar Expansion	Yes, of the inputs
Dimensionalized	Yes
Multidimensionalized	Yes
Zero Crossing	Yes, if enabled.

# MinMax Running Resettable

---

**Purpose** Determine minimum or maximum of signal over time

**Library** Math Operations

**Description** The MinMax Running Resettable block outputs the minimum or maximum of all past inputs  $u$ . You specify whether the block outputs the minimum or the maximum with the **Function** parameter.

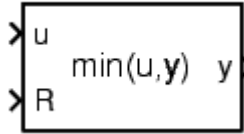

The block can reset its state based on an external reset signal  $R$ . When the reset signal  $R$  is TRUE, the block resets the output to the value of the **Initial condition** parameter.

The input can be a scalar, vector, or matrix signal. If you specify a scalar **Initial condition** parameter, the block expands the parameter to have the same dimensions as a nonscalar input. The block outputs a signal having the same dimensions as the input. Each output element equals the running minimum or maximum of the corresponding input elements.

**Data Type Support** The MinMax Running Resettable block accepts and outputs real signals of any data type supported by Simulink, except Boolean. The MinMax Running Resettable block supports fixed-point data types.

For a discussion on the data types supported by Simulink, see “Data Types Supported by Simulink” in the Simulink documentation.

# MinMax Running Resettable

## Parameters and Dialog Box

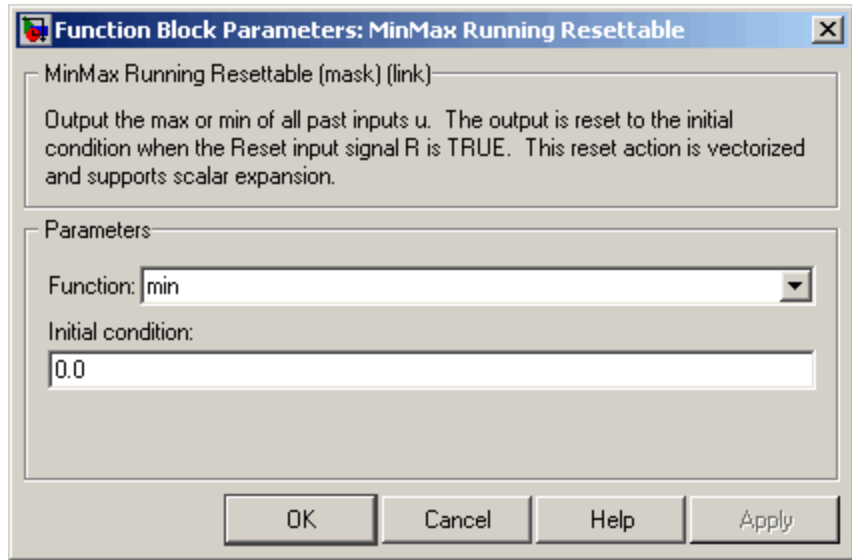

### Function

Specify whether the block outputs the minimum or the maximum.

### Initial condition

Initial condition.

## Characteristics

Direct Feedthrough	Yes
Scalar Expansion	Yes

# Model

**Purpose** Include model as block in another model

**Library** Ports & Subsystems

**Description** The Model block allows you to include a model as a block in another model. The Model block displays input ports and output ports corresponding to the included model's top-level input and output ports. This allows you to connect the included model to other blocks in the containing model. See "Referencing a Model" for more information.



**Data Type Support** Determined by the root-level inputs and outputs of the model referenced by the Model block.

## Parameters and Dialog Box

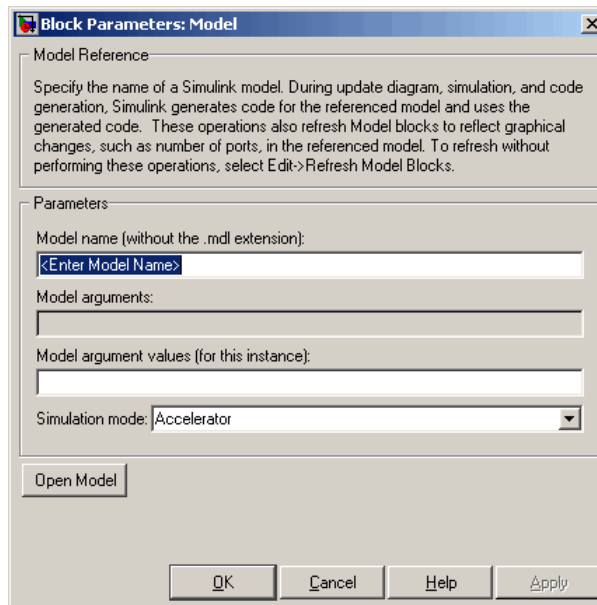

**Model Name** Name of the model referenced by this block. This name must be a valid MATLAB identifier. The model must exist on the MATLAB

path and the MATLAB path must contain no other model having the same name. See “Creating a Model Reference” for details.

### **Model arguments**

Names of model arguments accepted by the model referenced by this block. See “Using Model Arguments” for details.

### **Model argument values (for this instance)**

Values to be passed as model arguments to the model referenced by this block each time the model is invoked during a simulation. Enter the values in this field as a comma-separated list in the same order as the corresponding argument names appear in the **Model arguments** field. See “Using Model Arguments” for details.

### **Simulation mode**

The simulation mode for the model referenced by this block.

#### Accelerator

Simulink creates a MEX-file for the submodel, then executes the submodel by running the S-function.

#### Normal

Simulink executes the submodel interpretively, as if the submodel were an atomic subsystem implemented directly within the parent model.

See “Referenced Model Simulation Modes” for details.

## **Navigating a Model Block**

Model blocks behave differently from other blocks when double-clicked. This customized behavior provides the results most likely to be useful given the current status of the Model block, as follows:

- Double-clicking the prototype Model block in the Ports & Subsystems library opens its Block Parameters dialog box for inspection, but does not allow you to specify parameter values.

- Double-clicking an unresolved Model block opens its Block Parameters dialog box. You can then resolve the block by specifying a **Model name**.
- Double-clicking a resolved Model block opens the model that the block references. You can also open the model by choosing **Open Model** from the **Context** or **Edit** menu.

To display the Block Parameters dialog box for a resolved Model block, choose **Model Reference Parameters** from the **Context** or **Edit** menu.

## Model Blocks and Direct Feedthrough

ERT-based targets provide the option **Configuration Parameters > Real-Time Workshop Pane > Interface > Single output/update function**. When this option is enabled (the default) a Model block has a combined output and update function, which makes the block a direct feedthrough block for all inports regardless of the structure of the referenced model. When a Model block is part of a cycle, an algebraic loop can result. See:

- “Embedded Model Functions” for information about separate and combined output and update functions
- “Algebraic Loops” for information about direct feedthrough and algebraic loops.
- “Highlighting Algebraic Loops” for information about seeing algebraic loops graphically
- “Displaying Algebraic Loop Information” for information about tracing algebraic loops in the debugger.
- The “Diagnostics Pane: Solver” pane “Algebraic loop” option for information about detecting algebraic loops automatically.

An algebraic loop in a model is not necessarily an error, but it may not give the desired results. To eliminate an unwanted algebraic loop that includes a Model block, use any of the following techniques:

- Disable **Single output/update function**. The code for the Model block then has separate output and update functions, eliminating the direct feedthrough and hence the algebraic loop.
- Automatically eliminate the algebraic loop using techniques described in:
  - “Minimize algebraic loop”
  - “Minimize algebraic loop occurrences”
  - “Eliminating Algebraic Loops”
- Manually insert one or more Unit Delay blocks as needed to break the algebraic loop.

## Characteristics

Direct Feedthrough	Depends on the value of “Single output/update function”
Scalar Expansion	Depends on model referenced by this block.
Multidimensionalized	Yes

# Model Info

**Purpose** Display revision control information in model

**Library** Model-Wide Utilities

**Description** The Model Info block displays revision control information about a model as an annotation block in the model's block diagram. The following diagram illustrates use of a Model Info block to display information about the vdp model.

Model Info  
Annotation

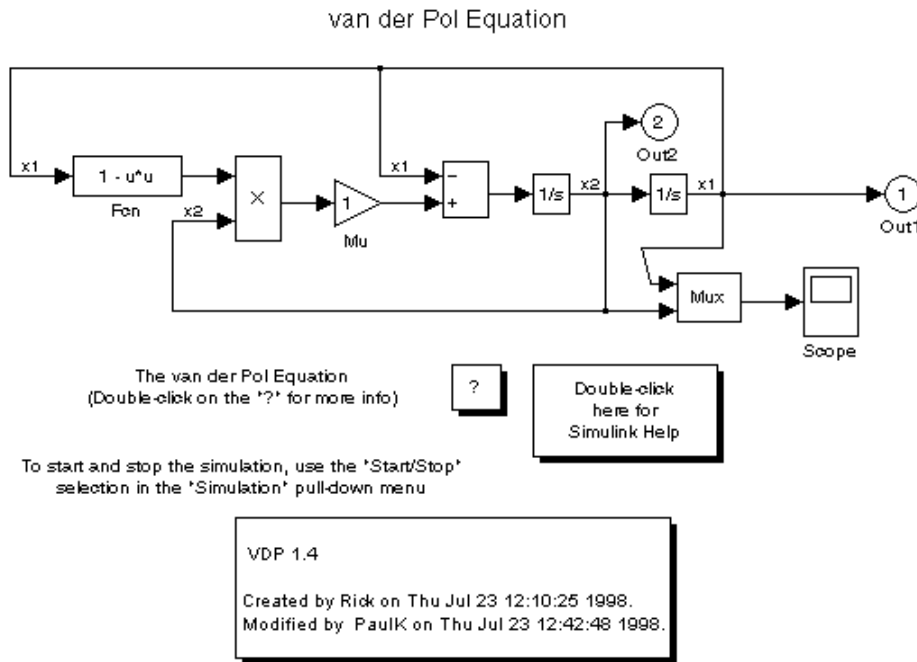

A Model Info block can show revision control information embedded in the model itself and/or information maintained by an external revision control or configuration management system. A Model Info block's dialog allows you to specify the content and format of the text displayed by the block.



## Data Type Support

Not applicable.

## Parameters and Dialog Box

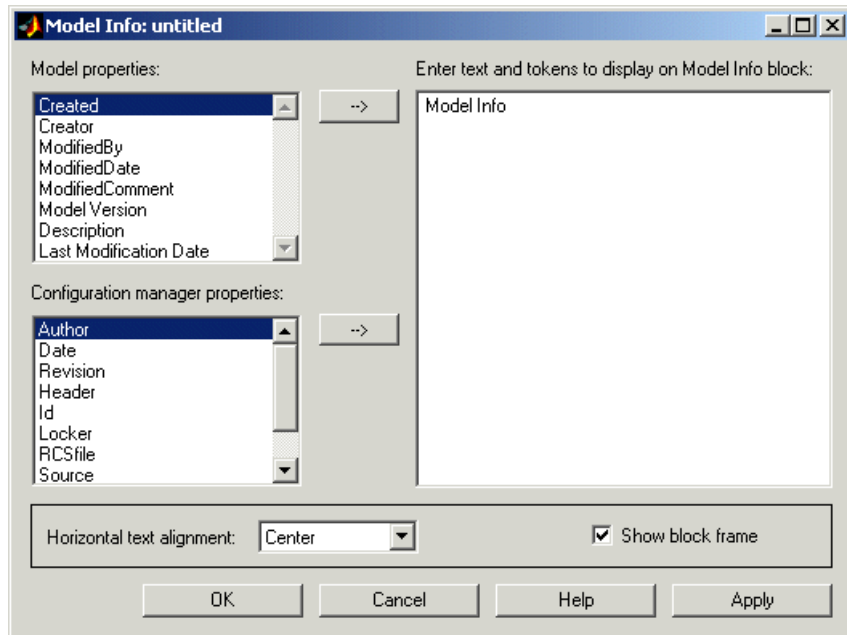

The Model Info block dialog box includes the following fields:

### Editable text

Enter the text to be displayed by the Model Info block in this field. You can freely embed variables of the form `%<proprname>`, where `proprname` is the name of a model or revision control system property, in the entered text. The value of the property replaces the variable in the displayed text. For example, suppose that the current version of the model is 1.1. Then the entered text

```
Version %<ModelVersion>
```

appears as

# Model Info

---

Version 1.1

in the displayed text. The model and revision control system properties that you can reference in this way are listed in the **Model properties** and **Configuration manager properties** fields.

## **Model properties**

Lists revision control properties stored in the model. Selecting a property and then selecting the adjacent arrow button enters the corresponding variable in the **Editable text** field. For example, selecting CreatedBy enters %<CreatedBy%> in the **Editable text** field. See “Version Control Properties” for a description of the usage of the properties specified in this field.

## **Configuration manager properties**

This field appears only if you previously specified an external configuration manager for this model on the MATLAB **Preferences** dialog box for the model (see “Specifying the Source Control System on UNIX” in the online MATLAB documentation) or by setting the model’s ConfigurationManager property. The field lists version control information maintained by the external system that you can include in the Model Info block. To include an item from the list, select it and then click the adjacent arrow button.

---

**Note** The selected item does not appear in the Model Info block until you check the model in or out of the repository maintained by the configuration manager and you have closed and reopened the model.

---

**Purpose** Choose between multiple block inputs

**Library** Signal Routing

## Description

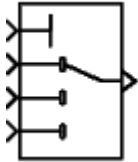

The Multiport Switch block chooses between a number of inputs. The first input is called the *control input*, while the rest of the inputs are called *data inputs*. The value of the control input determines which data input is passed through to the output port. (See “Changing the Orientation of a Block” in Using Simulink for a description of the port order for various block orientations.)

If the control input is an integer value, then the specified data input is passed through to the output. For example, suppose the **Use zero-based indexing** parameter is not selected. If the control input is 1, then the first data input is passed through to the output. If the control input is 2, then the second data input is passed through to the output, and so on. If the control input is not an integer value, the block first truncates the value to an integer by rounding to floor. If the truncated control input is less than 1 or greater than the number of input ports, an out-of-bounds error is returned.

You specify the number of data inputs with the **Number of inputs** parameter. The data inputs can be scalar or vector. The block output is determined by these rules:

- If you specify only one data input and that input is a vector, the block behaves as an “index selector,” and not as a multi-port switch. The block output is the vector element that corresponds to the value of the control input.
- If you specify more than one data input, the block behaves like a multi-port switch. The block output is the data input that corresponds to the value of the control input. If at least one of the data inputs is a vector, the block output is a vector. Any scalar inputs are expanded to vectors.
- If the inputs are scalar, the output is a scalar.

# Multiport Switch

---

The Index Vector block, also in the Signal Routing library, is another implementation of the Multiport Switch block that has different default parameter settings.

## **Data type support**

The control and data inputs of a Multiport Switch block can be signals of any data type supported by Simulink, except Boolean. The Multiport Switch block supports fixed-point data types.

The control inputs must be real. The data inputs can be real or complex.

For a discussion on the data types supported by Simulink, see “Data Types Supported by Simulink” in the Simulink documentation.

## Parameters and Dialog Box

The **Main** pane of the Multiport Switch block dialog appears as follows:

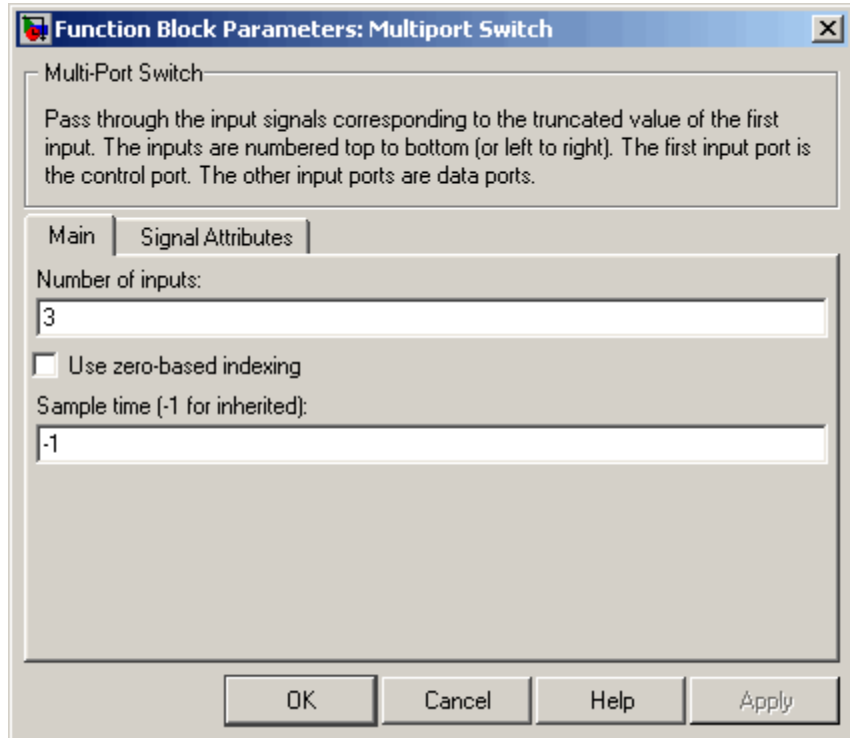

### Number of inputs

Specify the number of data inputs to the block.

### Use zero-based indexing

If selected, the block uses zero-based indexing. Otherwise, the block uses one-based indexing.

### Sample time (-1 for inherited)

Specify the time interval between samples. To inherit the sample time, set this parameter to -1. See "Specifying Sample Time" in the online documentation for more information.

# Multiport Switch

The **Signal Attributes** pane of the Multiport Switch block dialog appears as follows:

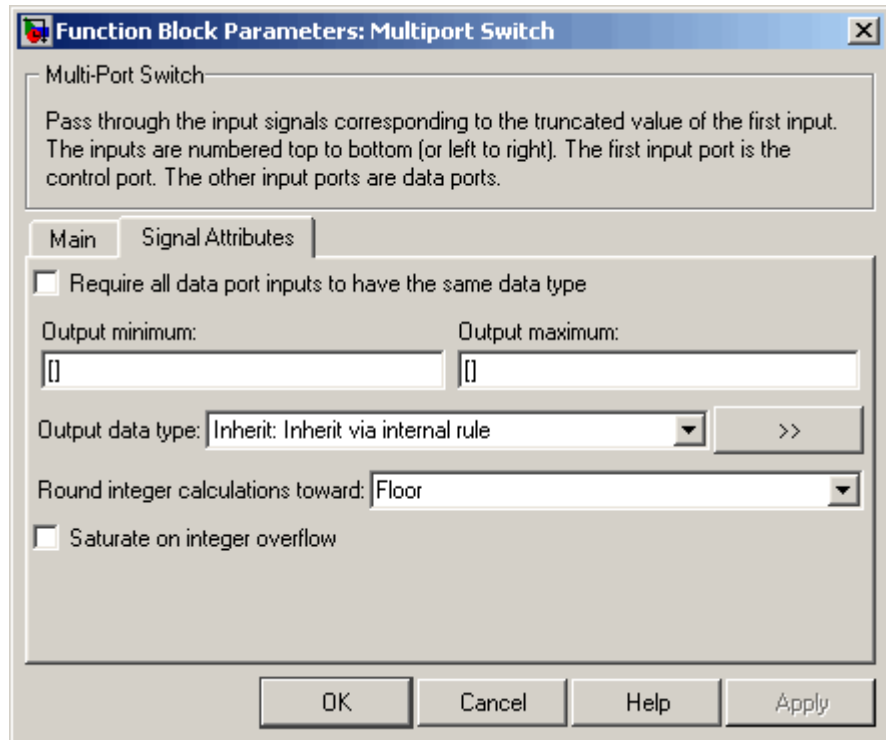

## **Require all data port inputs to have the same data type**

Select to require all data port inputs to have the same data type.

## **Output minimum**

Specify the minimum value that the block should output. The default value, [ ], is equivalent to  $-\text{Inf}$ . Simulink uses this value to perform:

- Simulation range checking (see “Checking Signal Ranges”)
- Automatic scaling of fixed-point data types

## Output maximum

Specify the maximum value that the block should output. The default value, [], is equivalent to Inf. Simulink uses this value to perform:

- Simulation range checking (see “Checking Signal Ranges”)
- Automatic scaling of fixed-point data types

## Output data type

Specify the output data type. You can set it to:

- A rule that inherits a data type, for example, Inherit: Inherit via back propagation
- The name of a built-in data type, for example, single
- The name of a data type object, for example, a Simulink.NumericType object
- An expression that evaluates to a data type, for example, float('single')

Click the **Show data type assistant** button  to display the **Data Type Assistant**, which helps you set the **Output data type** parameter.

See “Specifying Block Output Data Types” in *Using Simulink* for more information.

## Lock output scaling against changes by the autoscaling tool

Select to lock scaling of outputs. This parameter is visible only if you enter an expression for the **Output data type** parameter.

## Round integer calculations toward

Select the rounding mode for fixed-point operations.

## Saturate on integer overflow

Select to have overflows saturate.

# Multiport Switch

---

## Bus Support

The Multiport Switch block is a bus-capable block. The inputs can be virtual or nonvirtual bus signals subject to the following restrictions:

- The number of inputs must be greater than one.
- All inputs to the merge must be buses and must be equivalent (same hierarchy with identical names and attributes for all elements).

## Characteristics

Bus-capable	Yes, with restrictions as noted above
Direct Feedthrough	Yes
Sample Time	Specified in the <b>Sample time</b> parameter
Scalar Expansion	Yes
Dimensionalized	Yes
Multidimensionalized	Yes
Zero Crossing	No



**Purpose** Combine several input signals into vector

**Library** Signal Routing

## Description



The Mux block combines its inputs into a single vector output. An input can be a scalar or vector signal. All inputs should be of the same data type and numeric type. The elements of the vector output signal take their order from the top to bottom, or left to right, input port signals.

---

**Note** The Mux block allows you to connect signals of differing data and numeric types and matrix signals to its inputs. In this case, the Mux block outputs a bus signal combining the inputs. In other words, the Mux block behaves like a Bus Creator block. Nevertheless, you should use Bus Creator blocks in such cases to ensure that your model will run in future releases of Simulink, which may not support the use of Mux blocks as Bus Creators. If your model currently uses Mux blocks as Bus Creators, you may want to consider replacing the Mux blocks with equivalent Bus Creator blocks (see “Mux blocks used to create bus signals” for more information).

---

The Mux block’s **Number of Inputs** parameter allows you to specify input signal names and sizes as well as the number of inputs. You can use any of the following formats to specify this parameter:

- Scalar

Specifies the number of inputs to the Mux block. When this format is used, the block accepts scalar or vector signals of any size. Simulink assigns each input the name `signalN`, where `N` is the input port number.

- Vector

The length of the vector specifies the number of inputs. Each element specifies the size of the corresponding input. A positive value specifies that the corresponding port can accept only vectors of that

size. For example, [2 3] specifies two input ports of sizes 2 and 3, respectively. If an input signal width does not match the expected width, Simulink displays an error message. A value of -1 specifies that the corresponding port can accept scalars or vectors of any size.

- Cell array

The length of the cell array specifies the number of inputs. The value of each cell specifies the size of the corresponding input. A scalar value N specifies a vector of size N. A value of -1 means that the corresponding port can accept scalar or vector signals of any size.

- Signal name list

You can enter a list of signal names separated by commas. Simulink assigns each name to the corresponding port and signal. For example, if you enter position, velocity, the Mux block will have two inputs, named position and velocity.

---

**Note** Simulink hides the name of a Mux block when you copy it from the Simulink block library to a model.

---

## Data Type Support

The Mux block accepts real or complex signals of any data type supported by Simulink, including fixed-point data types.

For a discussion on the data types supported by Simulink, see “Data Types Supported by Simulink” in the Simulink documentation.

**Parameters and Dialog Box**

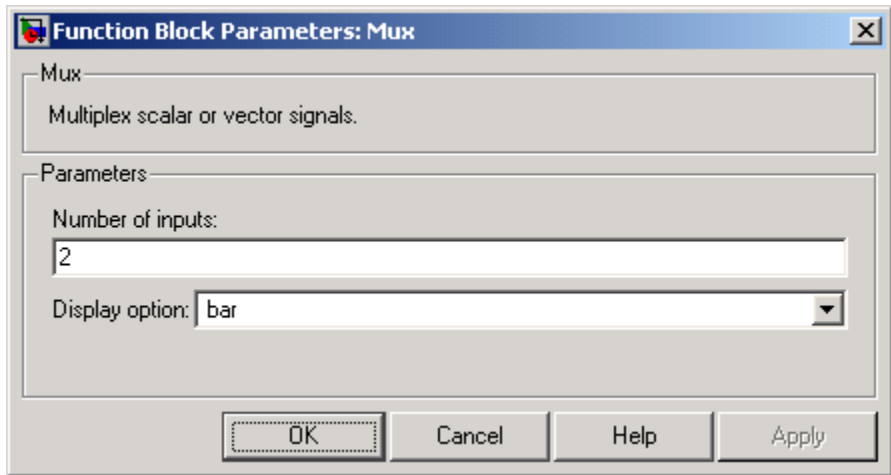

**Number of inputs**

The number and size of inputs. You can enter a comma-separated list of signal names for this parameter field.

**Display option**

The appearance of the block in the model.

Display Option	Appearance of Block in Model
none	Mux appears inside the block
signals	Displays signal names next to each port
bar	Displays the block in a solid foreground color

# Output

---

**Purpose** Create output port for subsystem or external output

**Library** Ports & Subsystems, Sinks

**Description** Output blocks are the links from a system to a destination outside the system.

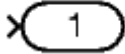

Simulink assigns Output block port numbers according to these rules:

- It automatically numbers the Output blocks within a top-level system or subsystem sequentially, starting with 1.
- If you add an Output block, it is assigned the next available number.
- If you delete an Output block, other port numbers are automatically renumbered to ensure that the Output blocks are in sequence and that no numbers are omitted.

## Output Blocks in a Subsystem

Output blocks in a subsystem represent outputs from the subsystem. A signal arriving at an Output block in a subsystem flows out of the associated output port on that Subsystem block. The Output block associated with an output port on a Subsystem block is the block whose **Port number** parameter matches the relative position of the output port on the Subsystem block. For example, the Output block whose **Port number** parameter is 1 sends its signal to the block connected to the topmost output port on the Subsystem block.

If you renumber the **Port number** of an Output block, the block becomes connected to a different output port, although the block continues to send the signal to the same block outside the subsystem.

When you create a subsystem by selecting existing blocks, if more than one Output block is included in the grouped blocks, Simulink automatically renumbers the ports on the blocks.

The Output block name appears in the Subsystem icon as a port label. To suppress display of the label, select the Output block and choose **Hide Name** from the **Format** menu.

## Output Blocks in a Conditionally Executed Subsystem

When an Output block is in an enabled subsystem, you can specify what happens to its output when the subsystem is disabled: it can be reset to an initial value or held at its most recent value. The **Output when disabled** pop-up menu provides these options. The **Initial output** parameter is the value of the output before the subsystem executes and, if the reset option is chosen, while the subsystem is disabled.

## Output Blocks in a Top-Level System

Output blocks in a top-level system have two uses: to supply external outputs to the workspace, which you can do by using either the **Configuration Parameters** dialog box or the `sim` command, and to provide a means for analysis functions to obtain output from the system.

- To supply external outputs to the workspace, use the **Configuration Parameters** dialog box (see Exporting Output Data to the MATLAB Workspace) or the `sim` command (see `sim`). For example, if a system has more than one Output block and the save format is array, the following command

```
[t,x,y] = sim(...);
```

writes `y` as a matrix, with each column containing data for a different Output block. The column order matches the order of the port numbers for the Output blocks.

If you specify more than one variable name after the second (state) argument, data from each Output block is written to a different variable. For example, if the system has two Output blocks, to save data from Output block 1 to `speed` and the data from Output block 2 to `dist`, you could specify this command:

```
[t,x,speed,dist] = sim(...);
```

- To provide a means for the `linmod` and `trim` analysis functions to obtain output from the system (see “Linearizing Models”)

## Data Type Support

The Output block accepts complex or real signals of any data type supported by Simulink. An Output block can also accept fixed-point data types if it is not a root-level output port. The complexity and data type of the block's output are the same as those of its input. For a discussion on the data types supported by Simulink, see "Data Types Supported by Simulink" in the Simulink documentation.

The elements of a signal array connected to an Output block can be of differing complexity and data types except in the following circumstance: If the output port is in a conditionally executed subsystem and the initial output is specified, all elements of an input array must be of the same complexity and data types.

Typical Simulink data type conversion rules apply to an output port's **Initial output** parameter. If the initial output value is in the range of the block's output data type, Simulink converts the initial output to the output data type. If the specified initial output is out of the range of the output data type, Simulink halts the simulation and signals an error.

## Parameters and Dialog Box

The **Main** pane of the Outport block dialog appears as follows:

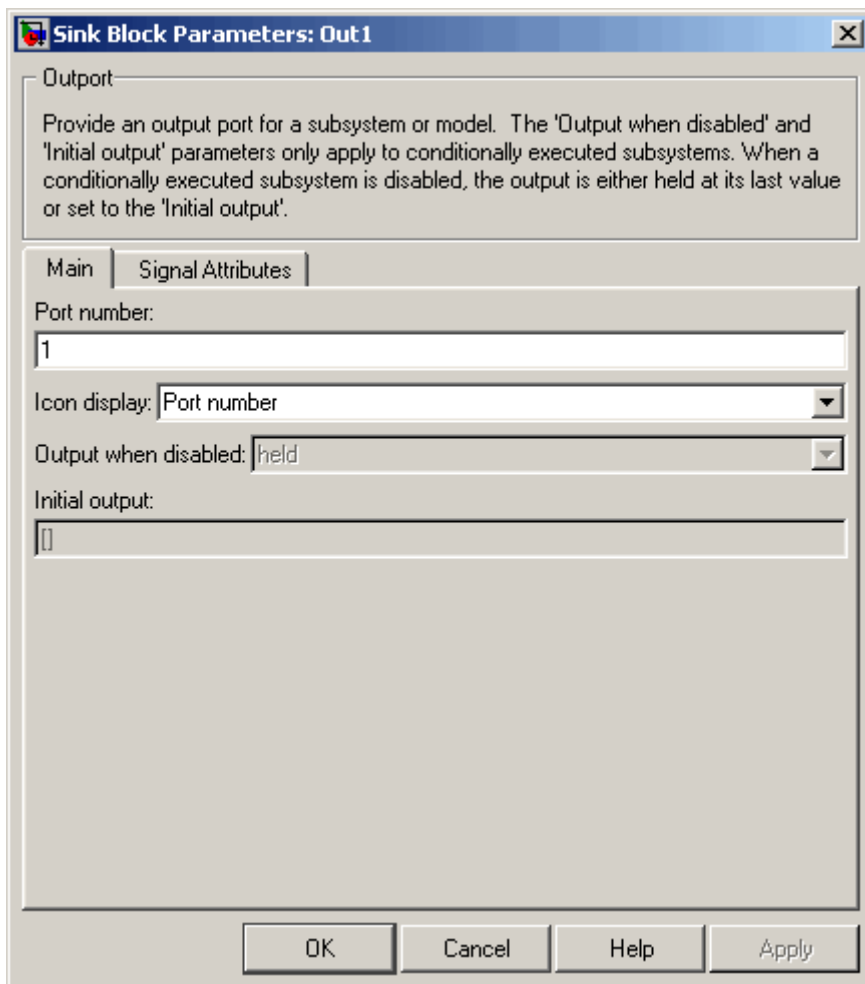

### Port number

Specify the port number of the Outport block.

## Icon Display

Specify the information to be displayed on the icon of this Output block. The options are:

Port number	Displays port number of this Output block.
Signal name	Displays the name of the signal connected to this Output block (or signals if a bus is connected to this block).
Port name and signal name	Displays both the port number and the name or names of the signals connected to this Output block.

## Output when disabled

This option is enabled only if the Output resides in an Enabled Subsystem. It specifies what happens to the block output when the system is disabled.

## Initial output

For conditionally executed subsystems, specify the block output before the subsystem executes and while it is disabled. You can specify [ ] if your model does not depend on the initial output of the conditionally executed subsystem. Simulink does not allow the initial output of this block to be `inf` or `NaN`.

The **Signal Attributes** pane of the Output block dialog appears as follows:



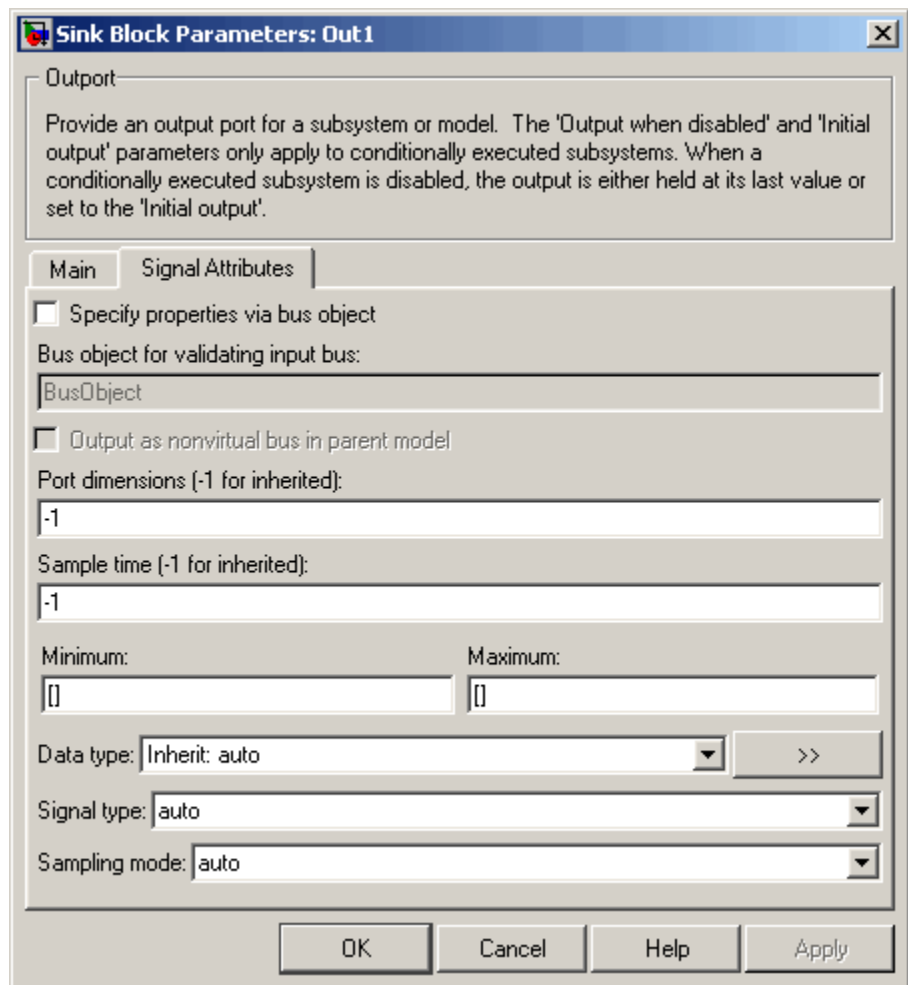

### Specify properties via bus object

Select this option to use a bus object (see “Working with Data Objects” and `Simulink.Bus` class in the online documentation) to define the properties of a bus connected to this Output block.

## **Bus object for validating input bus**

Specifies the name of the bus object that defines the structure that a bus must have to be connected to this Outputport block. At the beginning of a simulation or when you update the model's diagram, Simulink checks whether the bus connected to this block has the specified structure. If not, Simulink displays an error message.

## **Output as nonvirtual bus in parent model**

Select this option if you want code generated from this model to use a C structure to define the structure of the bus signal output by this block.

## **Port dimensions (-1 for inherited)**

Specifies the dimensions that a signal must have in order to be connected to this Outputport block. Valid values are:

- 1	A signal of any dimensions can be connected to this port.
N	The signal connected to this port must be a vector of size N.
[ R C ]	The signal connected to this port must be a matrix having R rows and C columns.

## **Sample time (-1 for inherited)**

Specify the sample time of this Outputport block. See “Specifying Sample Time” in the online documentation for information on specifying sample times. The output of this block changes at the specified rate to reflect the value of its input.

## **Minimum**

Specify the minimum value that the block should output. The default value, [], is equivalent to -Inf. Simulink uses this value to perform:

- Simulation range checking (see “Checking Signal Ranges”)
- Automatic scaling of fixed-point data types

## Maximum

Specify the maximum value that the block should output. The default value, [], is equivalent to Inf. Simulink uses this value to perform:

- Simulation range checking (see “Checking Signal Ranges”)
- Automatic scaling of fixed-point data types

## Data type

Specify the output data type. You can set it to:

- A rule that inherits a data type, for example, `Inherit: auto`
- The name of a built-in data type, for example, `single`
- The name of a data type object, for example, a `Simulink.NumericType` object
- An expression that evaluates to a data type, for example, `float('single')`

Click the **Show data type assistant** button  to display the **Data Type Assistant**, which helps you set the **Data type** parameter.

See “Specifying Block Output Data Types” in *Using Simulink* for more information.

## Signal type

Specifies the numeric type of the signal output by this block. The options are:

# Output

---

real	This Outputport block outputs a real-valued signal. The signal connected to this block must be real. If it is not, Simulink displays an error if you try to update the diagram or simulate the model that contains this block.
complex	This Outputport block outputs a complex signal. The signal connected to this block must be complex. If it is not, Simulink displays an error if you try to update the diagram or simulate the model that contains this block.
auto	This block outputs the numeric type of the signal that is connected to its input.

## Sampling mode

Specify the sampling mode (Sample based or Frame based) that the input signal must match. To accept any sampling mode, set this parameter to auto. This parameter is intended to support signal processing applications based on Simulink. See the documentation for the buffer function provided by Signal Processing Toolbox or “Frame-Based Signals” in the documentation for Signal Processing Blockset for information about frame-based signals.

## Characteristics

Sample Time	Inherited from driving block
Dimensionalized	Yes
Multidimensionalized	Yes

**Purpose** Rearrange dimensions of multidimensional array dimensions

**Library** Math Operations

**Description** The block reorders the elements of the input signal so that they are in the order that you specify in the **Order** parameter.



**Data Type Support** Accepts signals of any data type supported by Simulink, including fixed-point data types. Output must be the same data type as the input.

## Parameters and Dialog Box

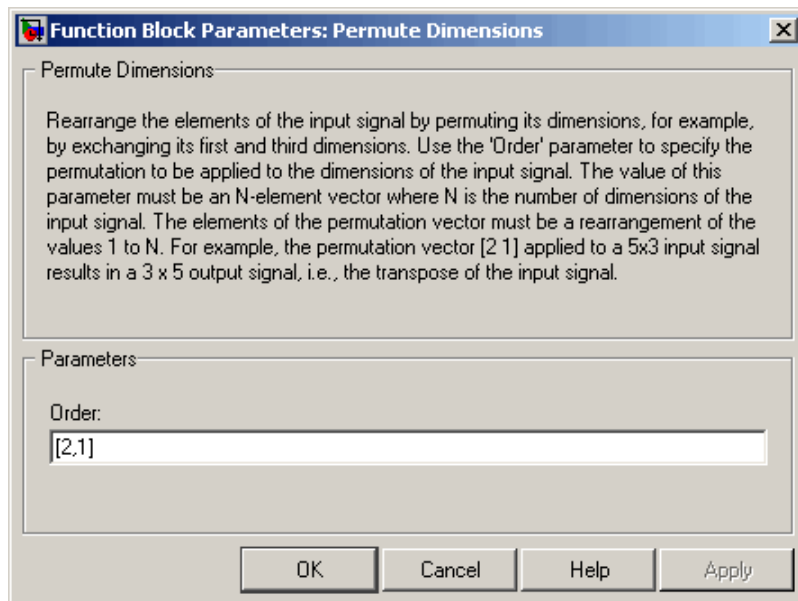

### Order

Specify the permutation order to apply to the dimensions of the input signal. This parameter is a vector of elements, where the

# Permute Dimensions

---

number of elements in the vector is the number of dimensions of the input signal.

<b>Characteristics</b>	Direct Feedthrough	Yes
	Sample Time	Inherited from driving block
	Scalar Expansion	No
	Dimensionalized	Yes
	Multidimensionalized	Yes
	Zero Crossing	No

**See Also** Math Function (transpose), permute (in the MATLAB reference documentation)

**Purpose** Perform evaluation of polynomial coefficients on input values

**Library** Math Operations

**Description** The Polynomial block uses a coefficients parameter to evaluate a real polynomial for the input value.

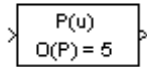

You define a set of polynomial coefficients in the form accepted by the MATLAB `polyval` command. The block then calculates  $P(u)$  at each time step for the input  $u$ . Inputs and coefficients must be real.

**Data Type Support** The Polynomial block accepts real signals of types `double` or `single`. The **Polynomial coefficients** parameter must be of the same type as the inputs. The output data type is set to the input data type.

## Parameters and Dialog Box

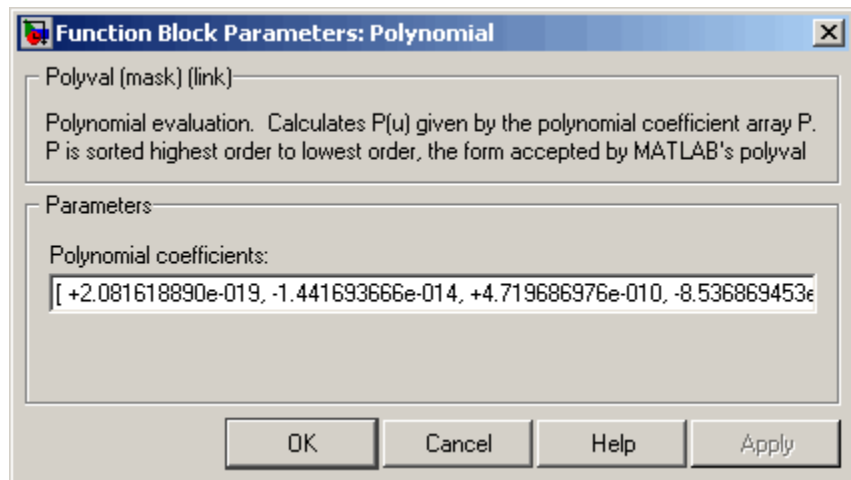

### Polynomial coefficients

Values are in coefficients of a polynomial in MATLAB `polyval` form, with the first coefficient representing  $x^N$ , then decreasing in order until the last coefficient, which represents the constant for the polynomial. See `polyval` in the MATLAB documentation for more information.

# Polynomial

---

## Characteristics

Direct Feedthrough	Yes
Sample Time	Inherited from driving block
Scalar Expansion	No
Dimensionalized	Yes
Zero Crossing	No



**Purpose** Compute index and fraction for Interpolation Using Prelookup block

**Library** Lookup Tables

## Description

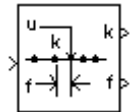

The Prelookup block is intended for use with the Interpolation Using Prelookup block. The Prelookup block calculates the index and interval fraction that specifies how its input value relates to the breakpoint data set. You feed the resulting index and fraction values into an Interpolation Using Prelookup block to interpolate an  $n$ -dimensional table. This combination of blocks performs the equivalent operation that a single instance of the Lookup Table (n-D) block performs. However, the Prelookup and Interpolation Using Prelookup blocks offer greater flexibility that can result in more efficient simulation performance.

To use this block, you must define a set of breakpoint values. In normal use, this breakpoint data set corresponds to one dimension of the **Table data** parameter in an Interpolation Using Prelookup block. The block generates a pair of outputs for each input value by calculating the

- Index of the breakpoint set element that is less than or equal to the input value
- Resulting fractional value that is a number  $0 \leq f < 1$ , representing the input value's normalized position between the index and the next index value for in-range input

For example, if the breakpoint data set is

[ 0 5 10 20 50 100 ]

and the input value  $u$  is 55, the index is 4 and the fractional value is 0.1, denoted respectively as  $k$  and  $f$  on the block. Note that the index value is zero-based.

# Prelookup

---

---

**Note** The interval fraction can be negative or greater than 1 for out-of-range input. See the documentation for the block's **Process out of range input** parameter for more information.

---

## Data Type Support

The Prelookup block accepts real signals of any data type supported by Simulink, except Boolean. The Prelookup block supports fixed-point data types.

For a discussion on the data types supported by Simulink, see “Data Types Supported by Simulink” in the Simulink documentation.

## Parameters and Dialog Box

The **Main** pane of the Prelookup block dialog appears as follows:

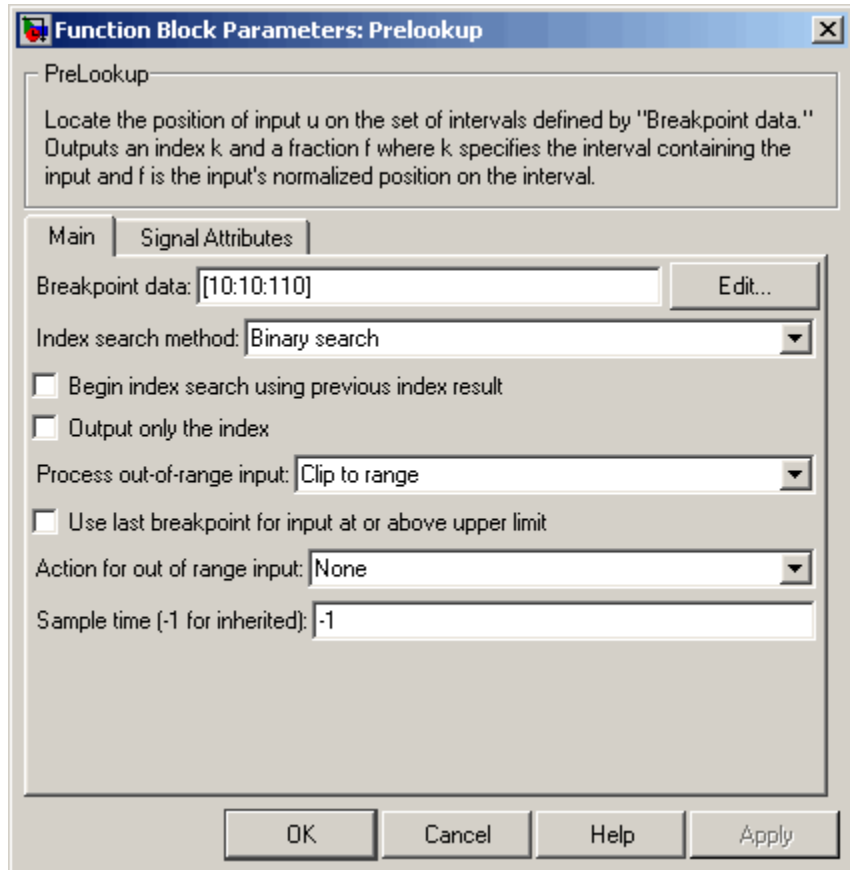

### Breakpoint data

The set of numbers to search. Specify a strictly monotonically increasing vector that contains two or more elements.

---

**Note** At runtime, the Prelookup block converts the data type of its **Breakpoint data** parameter to that of its input.

---

Click the **Edit** button to open the Lookup Table Editor (see “Lookup Table Editor” in the Simulink documentation).

### **Index search method**

Binary search, Evenly spaced points, or Linear search. Use Linear search in combination with **Begin index search using previous index result** for more efficient performance than Binary search when the input values do not change much from one time step to the next. For large breakpoint data sets, a linear search can be very slow if the input value changes by more than a few intervals from one time step to the next. Use Evenly spaced points if the elements of the **Breakpoint data** parameter are spaced apart evenly.

### **Begin index search using previous index result**

Select this option if you want the block to start its search using the index that was found at the previous time step. For inputs that change slowly with respect to the interval size, you can realize a large performance gain.

### **Output only the index**

If this block is not being used to feed an Interpolation Using Prelookup block, the interval fraction output can be dropped. In this case, the block outputs only the resulting index value.

### **Process out of range input**

Specifies how to handle out-of-range input. Options include:

- Clip to range

If the input is less than the first breakpoint, return the index of the first breakpoint (i.e., 0) and 0 for the interval fraction. If the input is greater than the last breakpoint, return the index of the next-to-last breakpoint and 1 for the interval fraction. For example, suppose the range is [1 2 3] and you select this

option. Then, if the input is 0.5, the index is 0 and the interval fraction is 0; if the input is 3.5, the index is 1 and the interval fraction is 1.

- **Linear extrapolation**

If the input is less than the first breakpoint, return the index of the first breakpoint (i.e., 0) and an interval fraction representing the linear distance from the input to the first breakpoint. If the input is greater than the last breakpoint, return the index of the next-to-last breakpoint and an interval fraction that represents the linear distance from the next-to-last breakpoint to the input. For example, suppose the range is [1 2 3] and you select this option. Then, if the input is 0.5, the index is 0 and the interval fraction is -0.5; if the input is 3.5, the index is 1 and the interval fraction is 1.5.

The Prelookup block supports Linear extrapolation only if all of the following conditions apply:

- The block input and its interval fraction specify the same floating-point data type.
- The data type of its index specifies a built-in integer.

### **Use last breakpoint for input at or above upper limit**

Specifies how to index inputs that are greater than or equal to the last breakpoint. If enabled when the block input equals the last breakpoint, the block returns the index of the last element in the breakpoint data set and 0 for the interval fraction. If disabled in this situation, the block returns the index of the next-to-last breakpoint and 1 for the interval fraction. Note that the index value is zero-based.

This parameter is visible only if **Output only the index** is unchecked and **Process out of range input** is Clip to range. However, if **Output only the index** is checked and **Process out of range input** is Clip to range, the block behaves as if this parameter is enabled even though it is invisible.

---

**Note** If you enable the **Use last breakpoint for input at or above upper limit** parameter for a Prelookup block, you must also enable the **Valid index input may reach last index** parameter for the Interpolation Using Prelookup block to which it connects. This allows the blocks to use the same indexing convention when accessing the last elements of their **Breakpoint data** and **Table data** parameters.

---

### Action for out of range input

Specifies whether to produce a warning or error message if the input is out of range. The options are

- None — the default, no warning or error message
- Warning — display a warning message in the MATLAB Command Window and continue the simulation
- Error — halt the simulation and display an error message in the Simulation Diagnostics Viewer

### Sample time

Specifies the time interval between samples. To inherit the sample time, set this parameter to -1. See “Specifying Sample Time” in the Simulink documentation for more information.

The **Signal Attributes** pane of the Prelookup block dialog appears as follows:

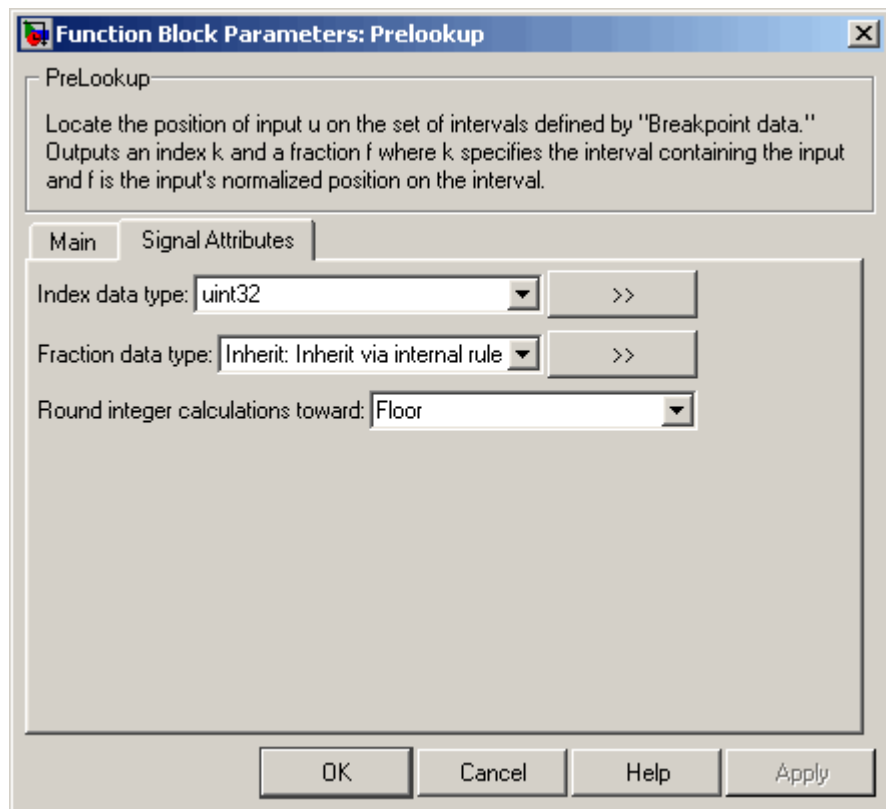

### Index data type

Specify how the data type of the index is designated. You can choose a built-in integer data type from the list, or you can specify an integer data type using a fixed-point representation. The data type that you specify must be capable of indexing all elements in the **Breakpoint data** parameter.

Click the **Show data type assistant** button  to display the **Data Type Assistant**, which helps you set the **Index data type** parameter.

See “Specifying Block Output Data Types” in *Using Simulink* for more information.

## **Fraction data type**

Specify how the data type of the interval fraction is designated. You can choose a built-in data type from the list, specify that the data type is inherited through an internal rule, or specify a fixed-point data type using either the [Slope Bias] or the binary-point-only scaling representation. If using the [Slope Bias] representation, the scaling must be trivial — i.e., the slope is 1 and the bias is 0. If using the binary-point-only representation, the fixed power-of-two exponent must be less than or equal to zero.

Click the **Show data type assistant** button  to display the **Data Type Assistant**, which helps you set the **Fraction data type** parameter.

See “Specifying Block Output Data Types” in *Using Simulink* for more information.

## **Lock output scaling against changes by the autoscaling tool**

Select to lock scaling of outputs. This parameter is visible only if you enter an expression for the **Fraction data type** parameter.

## **Round integer calculations toward**

Select the rounding mode for fixed-point operations.

Block parameters such as **Breakpoint data** are always rounded to the nearest representable value. To control the rounding of a block parameter, enter an expression using a MATLAB rounding function into the mask field.

## **Characteristics**

Direct Feedthrough	Yes
Sample Time	Specified in the <b>Sample time</b> parameter



Scalar Expansion	Yes
Dimensionalized	Yes
Zero Crossing	No

**See Also**

Interpolation Using Prelookup

# PreLookup Index Search (Obsolete)

## Purpose

First stage of high-performance constant or linear interpolation that performs index search and interval fraction calculation for input on breakpoint set

## Library

Lookup Tables

## Description

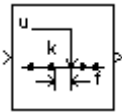

**Note** The PreLookup Index Search block is currently supported, but The MathWorks plans to remove this block in a future release. Use the Prelookup block instead. Among other enhancements, the Prelookup block provides support for fixed-point data types, consistency checking, and more efficient code generation.

The PreLookup Index Search block is intended for use with the Interpolation (n-D) Using PreLookup (Obsolete) block. The PreLookup Index Search block calculates the index and interval fraction that specifies how its input value relates to the breakpoint data set. You feed the resulting (index, fraction) pair into an Interpolation (n-D) Using PreLookup block to interpolate an  $n$ -dimensional table. This combination of blocks performs the equivalent operation that a single instance of the Lookup Table (n-D) block performs. But by using these blocks instead, you can potentially increase the simulation performance of models that use many interpolation blocks.

To use this block, you must define a set of breakpoint values. In normal use, this breakpoint data set corresponds to one dimension of a **Table data** parameter in an Interpolation (n-D) Using PreLookup block. The block generates a pair of outputs for each input value by calculating the index of the breakpoint set element that is less than or equal to the input value and the resulting fractional value that is a number  $0 \leq f < 1$  that represents the input value's normalized position between the index and the next index value for in-range input.

For example, if the breakpoint data is

```
[ 0 5 10 20 50 100 ]
```

# PreLookup Index Search (Obsolete)

and the input value  $u$  is 55, the (index, fraction) pair is (4, 0.1), denoted as  $k$  and  $f$  on the block. Note that the index value is zero-based.

---

**Note** The interval fraction can be negative or greater than 1 for out-of-range input. See the documentation for the block's **Process out of range input parameter** for more information.

---

## Data Type Support

The PreLookup Index Search block accepts signals of types double or single, but for any given block the inputs must all be of the same type. The **Breakpoint data** parameter must be of the same type as the inputs. The output data type is set to the input data type.

## Parameters and Dialog Box

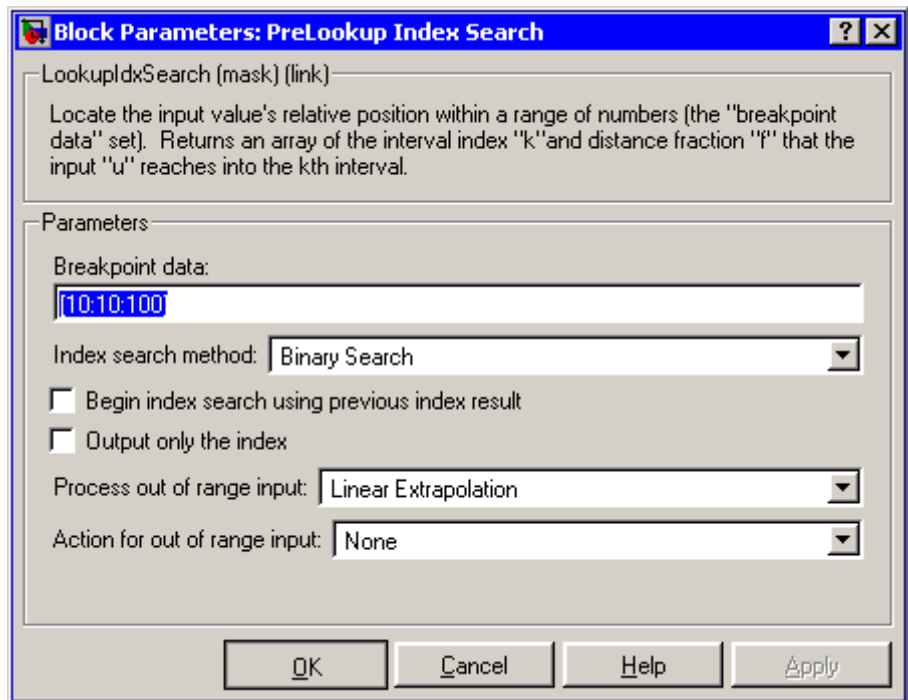

# PreLookup Index Search (Obsolete)

---

## **Breakpoint data**

The set of numbers to search.

## **Index search method**

Binary search, evenly spaced points, or linear search. Use linear search in combination with **Begin index search using previous index result** for higher performance than a binary search when the input values do not change much from one time step to the next. For large breakpoint sets, a linear search can be very slow if the input value changes by more than a few intervals from one time step to the next.

## **Begin index search using previous index result**

Select this option if you want the block to start its search using the index that was found on the previous time step. For inputs that change slowly with respect to the interval size, you can realize a large performance gain.

## **Output only the index**

If this block is not being used to feed an Interpolation (n-D) Using PreLookup block, the interval fraction output can be dropped and the resulting index value output is either an int32 or uint32 instead.

## **Process out of range input**

Specifies how to handle out-of-range input. Options include:

- Clip to Range

If the input is less than the first breakpoint, return the index of the first breakpoint (i.e., 0) and 0 for the interval fraction. If the input is greater than the last breakpoint, return the index of the next-to-the-last breakpoint and 1 for the interval fraction. For example, suppose the range is [1 2 3] and you select this option. Then, if the input is 0.5, the block returns [0 0]; if the input is 3.5, the block returns [1 1].

- Linear Extrapolation

# PreLookup Index Search (Obsolete)

If the input is less than the first breakpoint, return the index of the first breakpoint and an interval fraction representing the linear distance from the input to the first breakpoint. If the input is greater than the last breakpoint, return the index of the next-to-the-last breakpoint and an interval fraction that represents the linear distance from the next-to-the-last breakpoint to the input. For example, suppose the range is [1 2 3] and you select this option. Then, if the input is 0.5, the block returns [0 -0.5]; if the input is 3.5, the block returns [1 1.5].

## Action for out of range input

Specifies whether to produce a warning or error message if the input is out of range. The options are None (the default, no warning or error message), Warning (display a warning message in the MATLAB command window and continue the simulation), Error (halt the simulation and display an error message in the Simulation Diagnostics Viewer).

## Characteristics

Direct Feedthrough	Yes
Sample Time	Inherited from driving blocks
Scalar Expansion	Yes
Dimensionalized	Yes
Zero Crossing	No

## See Also

Interpolation (n-D) Using PreLookup (Obsolete)

# Product

---

**Purpose** Multiply or divide inputs

**Library** Math Operations

**Description** The Product block performs multiplication or division of its inputs.

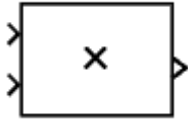

This block produces outputs using either element-wise or matrix multiplication, depending on the value of the **Multiplication** parameter. You specify the operations with the **Number of inputs** parameter. The Product block first performs the specified multiply or divide operations on the inputs, and then converts the results to the output data type using the specified rounding and overflow modes.

**Data Type Support** The Product block accepts real or complex signals of any data type supported by Simulink including fixed-point data types.

---

**Note** The Product block does not accept complex signals for inputs marked “/”, if you specify a fixed-point data type for any of its input or output signals.

---

For a discussion on the data types supported by Simulink, see “Data Types Supported by Simulink” in the Simulink documentation.

## Parameters and Dialog Box

The **Main** pane of the Product dialog appears as follows:

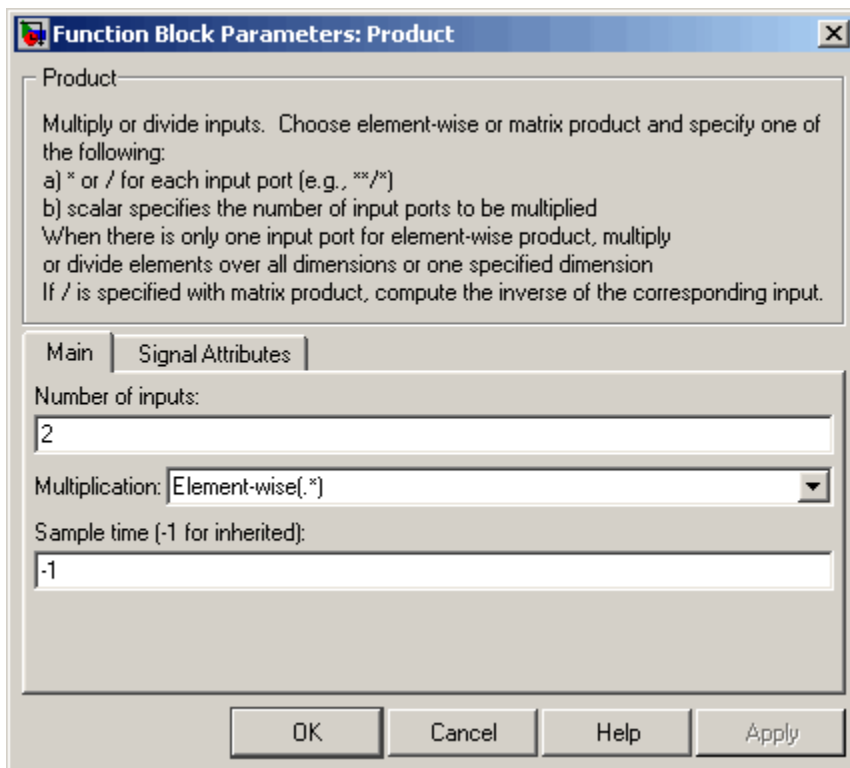

### Number of inputs

Enter the number of inputs or a combination of “\*” and “/” symbols. Multiply (\*) and divide (/) characters indicate the operations to be performed on the inputs:

- If there are two or more inputs, then the number of characters must equal the number of inputs. For example, “\*/\*” requires three inputs. For this example, if the **Multiplication** parameter is set to Element-wise(.\*), the block divides the elements of the first input by the elements of the second input,

and then multiplies by the elements of the third input. (See “Changing the Orientation of a Block” in *Using Simulink* for a description of the port order for various block orientations.) In this case, all nonscalar inputs to this block must have the same dimensions.

---

**Note** The Product block internally reorders its first two inputs,  $u1$  and  $u2$ , if all of the following conditions apply:

- **Number of inputs** parameter begins with “/”.
- **Multiplication** parameter specifies Element-wise (. \*).
- Any of the block input signals specify integer, fixed-point, or a mixture of double and single data types.

In this case, the block computes the simplified expression

$$u2 / u1$$

instead of the default computation

$$(1 / u1) * u2$$

The reordered computation provides more accurate results and is more efficient.

---

If, however, the **Multiplication** parameter is set to `Matrix(*)`, the block output is the matrix product of the inputs marked “\*” and the inverse of inputs marked “/”, with the order of operations following the entry in the **Number of inputs** parameter. The dimensions of the inputs must be such that the matrix product is defined.



---

**Note** To perform a dot product on input vectors, use the Dot Product block.

---

- If only multiplication of inputs is required, then a numeric parameter value equal to the number of inputs can be supplied instead of “\*” characters. This may be used with either element-wise or matrix multiplication.
- If there is only one input port and the **Multiplication** parameter is set to `Element-wise(.*)`, a single “\*” or “/” collapses the input signal using the specified operation. However, if the **Multiplication** parameter is set to `Matrix(*)`, a single “\*” causes the block to output the matrix unchanged, and a single “/” causes the block to output the matrix inverse.

### **Multiplication**

Specify element-wise or matrix multiplication.

---

**Note** This block supports multidimensional signals only for element-wise multiplication.

---

### **Multiply over** (Product of Elements block)

Specify the collapse mode. Select `All` dimensions or `Specified dimension`.

### **Dimension** (Product of Elements block)

Specify the dimension over which the operation is to be performed. This parameter appears only if you select `Specified dimension` for the **Multiply over** parameter.

### **Sample time (-1 for inherited)**

Specify the time interval between samples. To inherit the sample time, set this parameter to `-1`. See “Specifying Sample Time” in the online documentation for more information.

The **Signal Attributes** pane of the Product dialog appears as follows:

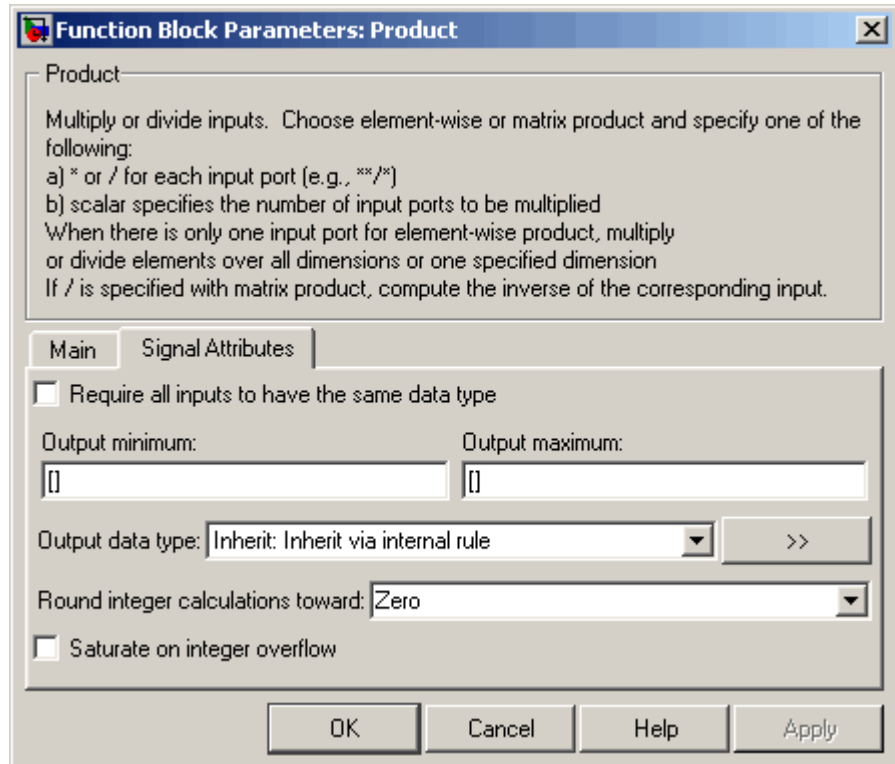

### **Require all inputs to have the same data type**

Select this parameter to require that all inputs have the same data type.

### **Output minimum**

Specify the minimum value that the block should output. The default value, [ ], is equivalent to  $-\infty$ . Simulink uses this value to perform:

- Simulation range checking (see “Checking Signal Ranges”)

- Automatic scaling of fixed-point data types

### Output maximum

Specify the maximum value that the block should output. The default value, [], is equivalent to Inf. Simulink uses this value to perform:

- Simulation range checking (see “Checking Signal Ranges”)
- Automatic scaling of fixed-point data types

### Output data type

Specify the output data type. You can set it to:

- A rule that inherits a data type, for example, Inherit: Inherit via back propagation
- The name of a built-in data type, for example, single
- The name of a data type object, for example, a Simulink.NumericType object
- An expression that evaluates to a data type, for example, float('single')

Click the **Show data type assistant** button  to display the **Data Type Assistant**, which helps you set the **Output data type** parameter.

See “Specifying Block Output Data Types” in *Using Simulink* for more information.

If you select Inherit: Inherit via internal rule for this parameter, Simulink chooses a combination of output scaling and data type that requires the smallest amount of memory consistent with accommodating the output range and maintaining the output precision (and avoiding underflow in the case of division operations). If the **Device type** parameter on the **Hardware Implementation** pane of the Configuration Parameters dialog is set to Custom, Simulink chooses the data type without regard to

hardware constraints. Otherwise, Simulink chooses the smallest available hardware data type capable of meeting range, precision, and underflow constraints. For example, if the block multiplies inputs of type `int8` and `int16` and `Custom` is specified as the device type, the output data type is `sfix24`. If `Unspecified` (assume 32-bit generic) is specified, the output data type is `int32`. If none of the word lengths provided by the target hardware can accommodate the output range, Simulink displays an error message in the Simulation Diagnostics Viewer.

**Lock output scaling against changes by the autoscaling tool**

Select to lock scaling of outputs. This parameter is visible only if you enter an expression for the **Output data type** parameter.

**Round integer calculations toward**

Select the rounding mode for fixed-point operations.

**Saturate on integer overflow**

Select to have overflows saturate.

## Characteristics

Direct Feedthrough	Yes
Sample Time	Specified in the <b>Sample time</b> parameter
Scalar Expansion	Yes
Dimensionalized	Yes
Multidimensionalized	Yes, only when the <b>Multiplication</b> parameter specifies <code>Element-wise(.*)</code>
Zero Crossing	No

**Purpose** Multiply or divide inputs

**Library** Math Operations

**Description** The Product of Elements block is an implementation of the Product block. See Product for more information.

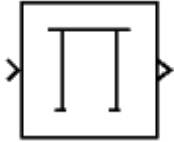

# Probe

---

<b>Purpose</b>	Output signal's attributes, including width, dimensionality, sample time, and/or complex signal flag
<b>Library</b>	Signal Attributes
<b>Description</b>	<p>The Probe block outputs selected information about the signal on its input. The block can output the input signal's width, dimensionality, sample time, and/or a flag indicating whether the input is a complex-valued signal. The block has one input port. The number of output ports depends on the information that you select for probing, that is, signal dimensionality, sample time, and/or complex signal flag. Each probed value is output as a separate signal on a separate output port. The block accepts real or complex-valued signals of any built-in data type. It outputs signals of type <code>double</code>. During simulation, the block's icon displays the probed data.</p>
<b>Data Type Support</b>	<p>The Probe block accepts and outputs any data type supported by Simulink, including fixed-point data types.</p> <p>For a discussion on the data types supported by Simulink, see “Data Types Supported by Simulink” in the Simulink documentation.</p>

## Parameters and Dialog Box

The **Main** pane of the Probe block dialog appears as follows:

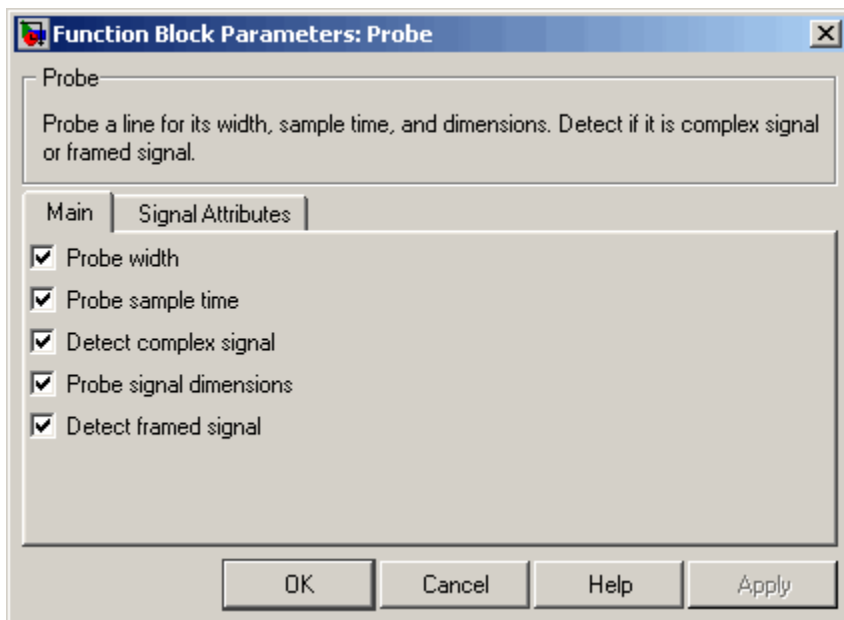

### Probe width

Select to output the width, or number of elements, of the probed signal.

### Probe sample time

Select to output the sample time of the probed signal. The output is a 2x1 vector that specifies the period and offset of the sample time, respectively. See “Specifying Sample Time” for more information.

### Detect complex signal

Select to output 1 if the probed signal is complex; otherwise, 0.

### Probe signal dimensions

Select to output the dimensions of the probed signal.

# Probe

---

## Detect framed signal

Select to output 1 if the probed signal is framed; otherwise, 0.

The **Signal Attributes** pane of the Probe block dialog appears as follows:

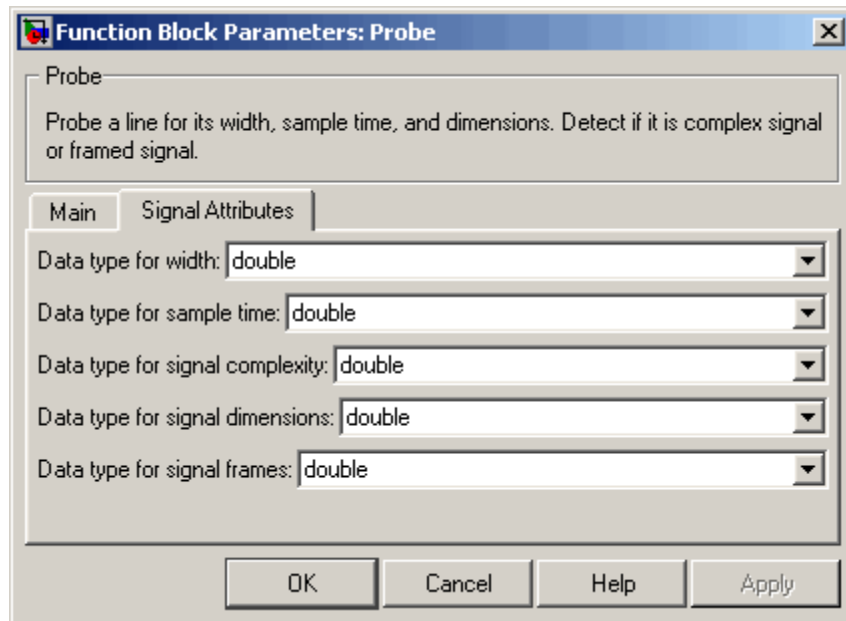

---

**Note** The Probe block ignores the **Data type override** setting of the Fixed-Point Tool.

---

## Data type for width

Select the output data type for the width information.

## Data type for sample time

Select the output data type for the sample time information.



**Data type for signal complexity**

Select the output data type for the complexity information.

**Data type for signal dimensions**

Select the output data type for the dimensions information.

**Data type for signal frames**

Select the output data type for the frames information.

**Characteristics**

Direct Feedthrough	Yes
Sample Time	Inherited from driving block
Scalar Expansion	Yes
Dimensionalized	Yes
Multidimensionalized	Yes
Zero Crossing	No

# Pulse Generator

**Purpose** Generate square wave pulses at regular intervals

**Library** Sources

## Description



The Pulse Generator block generates square wave pulses at regular intervals. The block's waveform parameters, **Amplitude**, **Pulse Width**, **Period**, and **Phase Delay**, determine the shape of the output waveform. The following diagram shows how each parameter affects the waveform.

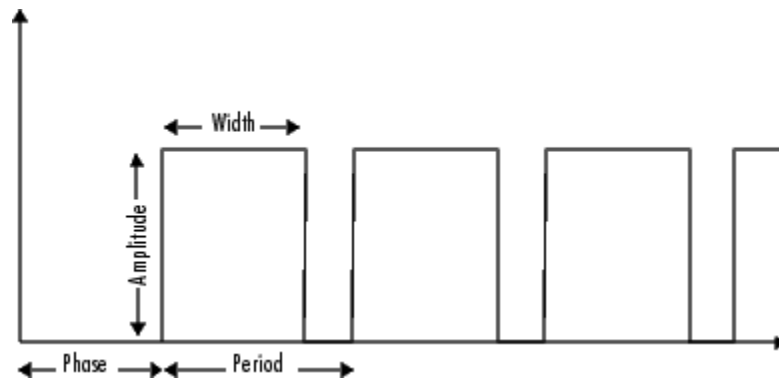

The Pulse Generator can emit scalar, vector, or matrix signals of any real data type. To cause the block to emit a scalar signal, use scalars to specify the waveform parameters. To cause the block to emit a vector or matrix signal, use vectors or matrices, respectively, to specify the waveform parameters. Each element of the waveform parameters affects the corresponding element of the output signal. For example, the first element of a vector amplitude parameter determines the amplitude of the first element of a vector output pulse. All the waveform parameters must have the same dimensions after scalar expansion. The data type of the output is the same as the data type of the **Amplitude** parameter.

The block's **Pulse type** parameter allows you to specify whether the block's output is time-based or sample-based. If you select *sample-based*, the block computes its outputs at fixed intervals that you

specify. If you select *time-based*, Simulink computes the block's outputs only at times when the output actually changes. This can result in fewer computations being required to compute the block's output over the simulation time period.

Depending on the pulse's waveform characteristics, the intervals between changes in the block's output can vary. For this reason, a time-based Pulse Generator block is said to have a variable sample time. Simulink uses brown as the sample time color of such blocks (see "Displaying Sample Time Colors" for more information).

Simulink cannot use a fixed-step solver to compute the output of a time-based pulse generator. If you specify a fixed-step solver for models that contain time-based pulse generators, Simulink computes a fixed sample time for the time-based pulse generators. It then simulates the time-based pulse generators as sample-based.

---

**Note** If you use a fixed-step solver and the **Pulse type** is time-based, you must choose the step size such that the period, phase delay, and pulse width (in seconds) are integer multiples of the step size. For example, suppose that the period is 4 seconds, the pulse width is 75% (i.e., 3 s), and the phase delay is 1 s. In this case, the computed sample time is 1 s. Therefore, you must choose a fixed-step size that is 1 or that divides 1 exactly (e.g., 0.25). You can guarantee this by setting the fixed-step solver's step size to auto on the **Configuration Parameters** dialog box.

---

If you select time-based as the block's pulse type, you must specify the pulse's phase delay and period in units of seconds. If you specify sample-based, you must specify the block's sample time in seconds, using the **Sample Time** parameter, then specify the block's phase delay and period as integer multiples of the sample time. For example, suppose that you specify a sample time of 0.5 second. And suppose you want the pulse to repeat every two seconds. In this case, you would specify 4 as the value of the block's **Period** parameter.

# Pulse Generator

---

## Data Type Support

The Pulse Generator block outputs real signals of any data type supported by Simulink, including fixed-point data types. The data type of the output signal is the same as that of the **Amplitude** parameter.

For a discussion on the data types supported by Simulink, see “Data Types Supported by Simulink” in the Simulink documentation.

## Parameters and Dialog Box

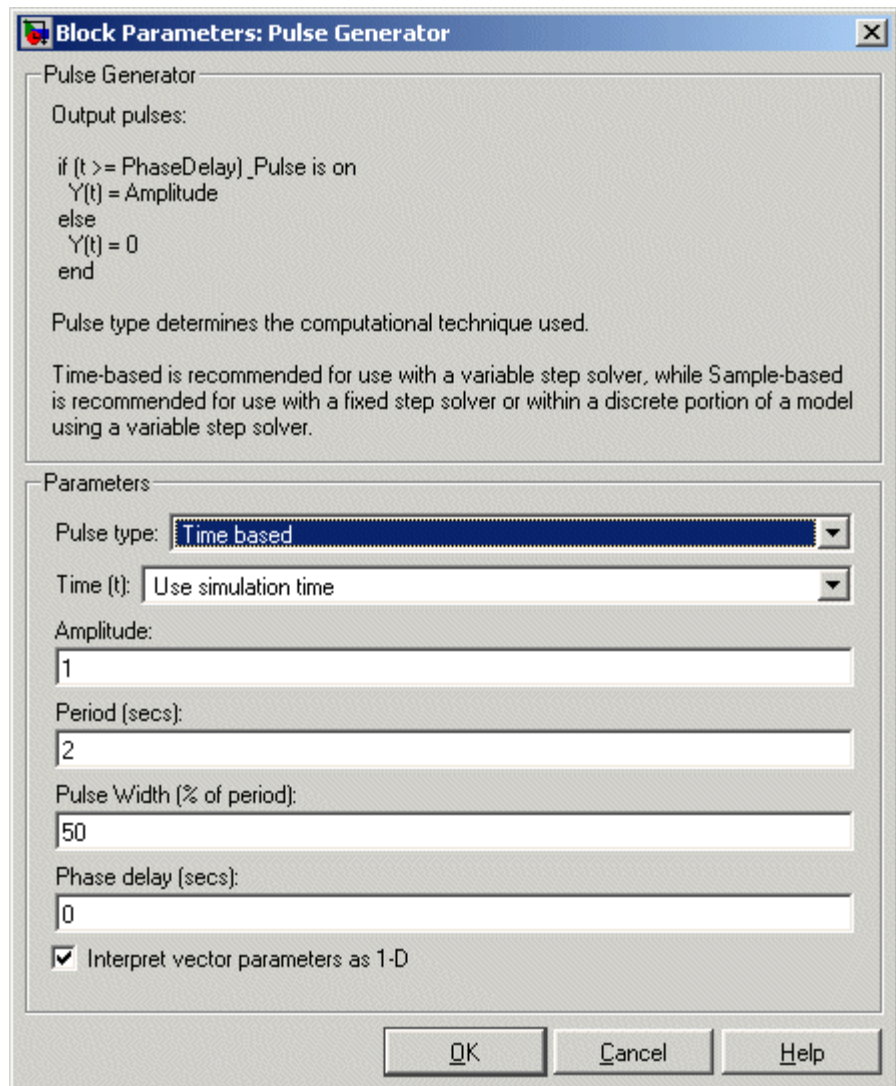

# Pulse Generator

---

Opening this dialog box causes a running simulation to pause. See “Changing Source Block Parameters During Simulation” in the online Simulink documentation for details.

## **Pulse type**

The pulse type for this block: time-based or sample-based. The default is time-based.

## **Time**

Specifies whether to use simulation time or an external signal as the source of values for the output signal’s time variable. If you specify an external source, the block displays an input port for connecting the source.

## **Amplitude**

The pulse amplitude. The default is 1.

## **Period**

The pulse period specified in seconds if the pulse type is time-based or as number of sample times if the pulse type is sample-based. The default is 2.

## **Pulse width**

The duty cycle specified as the percentage of the pulse period that the signal is on if time-based or as number of sample times if sample-based. The default is 50 percent.

## **Phase delay**

The delay before the pulse is generated specified in seconds if the pulse type is time-based or as number of sample times if the pulse type is sample-based. The default is 0 seconds.

## **Sample Time**

The length of the sample time for this block in seconds. This parameter appears only if the block’s pulse type is sample-based. See “Specifying Sample Time” for more information.

## **Interpret vector parameters as 1-D**

If you select this option and the other parameters are one-row or one-column matrices, after scalar expansion, the block outputs

a 1-D signal (vector). Otherwise the output dimensionality is the same as that of the other parameters. See “Determining the Output Dimensions of Source Blocks” in the “Working with Signals” chapter of the Using Simulink documentation.

## Characteristics

Sample Time	Inherited
Scalar Expansion	Yes, of parameters
Dimensionalized	Yes
Zero Crossing	No

# Quantizer

**Purpose** Discretize input at specified interval

**Library** Discontinuities

## Description

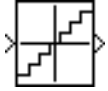

The Quantizer block passes its input signal through a stair-step function so that many neighboring points on the input axis are mapped to one point on the output axis. The effect is to quantize a smooth signal into a stair-step output. The output is computed using the round-to-nearest method, which produces an output that is symmetric about zero.

$$y = q * \text{round}(u/q)$$

where  $y$  is the output,  $u$  the input, and  $q$  the **Quantization interval** parameter.

## Data Type Support

The Quantizer block accepts and outputs real or complex signals of type single or double.

## Parameters and Dialog Box

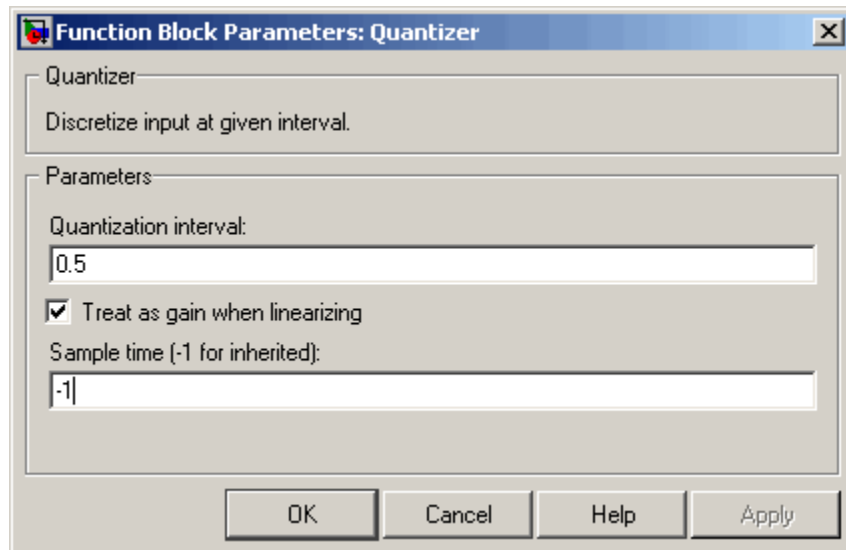



## Quantization interval

The interval around which the output is quantized. Permissible output values for the Quantizer block are  $n \cdot q$ , where  $n$  is an integer and  $q$  the **Quantization interval**. The default is 0.5.

## Treat as gain when linearizing

Simulink by default treats the Quantizer block as unity gain when linearizing. This is the large signal linearization case. If you clear this box, the linearization routines assume the small signal case and set the gain to zero.

## Sample time (-1 for inherited)

Specify the sample time of this Output block. See “Specifying Sample Time” in the online documentation for information on specifying sample times. The output of this block changes at the specified rate to reflect the value of its input.

## Characteristics

Direct Feedthrough	Yes
Sample Time	Inherited from driving block
Scalar Expansion	Yes, of parameter
Dimensionalized	Yes
Zero Crossing	No

# Ramp

---

**Purpose** Generate constantly increasing or decreasing signal

**Library** Sources

## Description



The Ramp block generates a signal that starts at a specified time and value and changes by a specified rate. The block's **Slope**, **Start time**, and **Initial output** parameters determine the characteristics of the output signal. All must have the same dimensions after scalar expansion.

## Data Type Support

The Ramp block outputs signals of type double.

## Parameters and Dialog Box

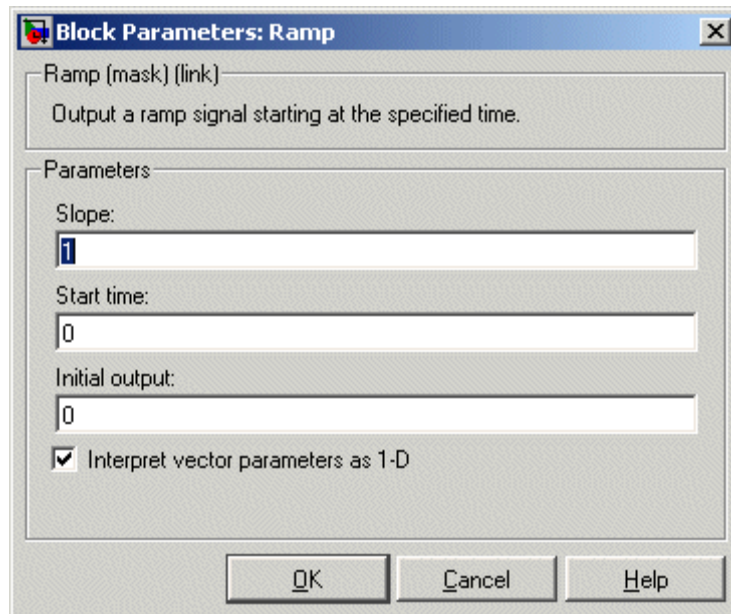

Opening this dialog box causes a running simulation to pause. See “Changing Source Block Parameters During Simulation” in the online Simulink documentation for details.

## Slope

The rate of change of the generated signal. The default is 1.

## Start time

The time at which the signal begins to be generated. The default is 0.

## Initial output

The initial value of the signal. The default is 0.

## Interpret vector parameters as 1-D

If you select this option and the other parameters are one-row or one-column matrices, after scalar expansion, the block outputs a 1-D signal (vector). Otherwise, the output dimensionality is the same as that of the other parameters. See “Determining the Output Dimensions of Source Blocks” in the “Working with Signals” chapter of the Using Simulink documentation.

## Characteristics

Sample Time	Inherited from driven block
Scalar Expansion	Yes
Dimensionalized	Yes
Zero Crossing	Yes

# Random Number

---

**Purpose** Generate normally distributed random numbers

**Library** Sources

## Description



The Random Number block generates normally distributed random numbers. The seed is reset to the specified value each time a simulation starts.

By default, the sequence produced has a mean of 0 and a variance of 1, although you can vary these parameters. The sequence of numbers is repeatable and can be produced by any Random Number block with the same seed and parameters. To generate a vector of random numbers with the same mean and variance, specify the **Initial seed** parameter as a vector.

To generate uniformly distributed random numbers, use the Uniform Random Number block.

Avoid integrating a random signal, because solvers are meant to integrate relatively smooth signals. Instead, use the Band-Limited White Noise block.

All the block's numeric parameters must be of the same dimension after scalar expansion.

## Data Type Support

The Random Number block accepts and outputs signals of type double.

## Parameters and Dialog Box

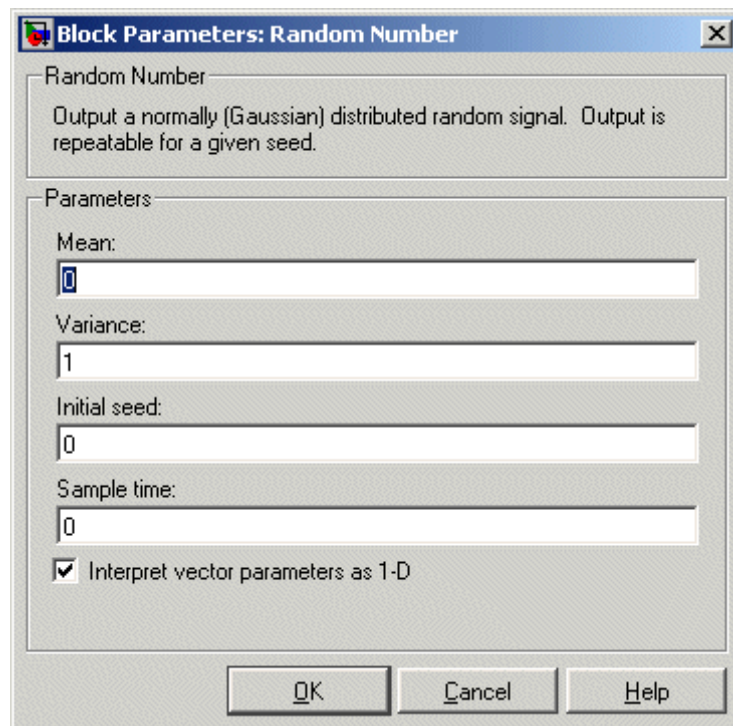

Opening this dialog box causes a running simulation to pause. See “Changing Source Block Parameters During Simulation” in the online Simulink documentation for details.

### Mean

The mean of the random numbers. The default is 0.

### Variance

The variance of the random numbers. The default is 1.

### Initial seed

The starting seed for the random number generator. The seed must be 0 or a positive integer. The default is 0.

# Random Number

---

## Sample time

The time interval between samples. The default is 0, causing the block to have continuous sample time. See “Specifying Sample Time” in the online documentation for more information.

## Interpret vector parameters as 1-D

If you select this option and the other parameters are one-row or one-column matrices, after scalar expansion, the block outputs a 1-D signal (vector). Otherwise, the output dimensionality is the same as that of the other parameters. See “Determining the Output Dimensions of Source Blocks” in the “Working with Signals” chapter of the Using Simulink documentation.

## Characteristics

Sample Time	Specified in the <b>Sample time</b> parameter
Scalar Expansion	Yes, of parameters
Dimensionalized	Yes
Multidimensionalized	Yes
Zero Crossing	No

**Purpose** Limit rate of change of signal

**Library** Discontinuities

## Description

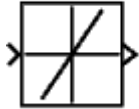

The Rate Limiter block limits the first derivative of the signal passing through it. The output changes no faster than the specified limit. The derivative is calculated using this equation.

$$rate = \frac{u(i) - y(i-1)}{t(i) - t(i-1)}$$

$u(i)$  and  $t(i)$  are the current block input and time, and  $y(i-1)$  and  $t(i-1)$  are the output and time at the previous step. The output is determined by comparing  $rate$  to the **Rising slew rate** and **Falling slew rate** parameters:

- If  $rate$  is greater than the **Rising slew rate** parameter ( $R$ ), the output is calculated as

$$y(i) = \Delta t \cdot R + y(i-1)$$

- If  $rate$  is less than the **Falling slew rate** parameter ( $F$ ), the output is calculated as

$$y(i) = \Delta t \cdot F + y(i-1)$$

- If  $rate$  is between the bounds of  $R$  and  $F$ , the change in output is equal to the change in input:

$$y(i) = u(i)$$

## Data Type Support

The Rate Limiter block accepts and outputs signals of any data type supported by Simulink, except Boolean. The Rate Limiter block supports fixed-point data types.

# Rate Limiter

## Parameters and Dialog Box

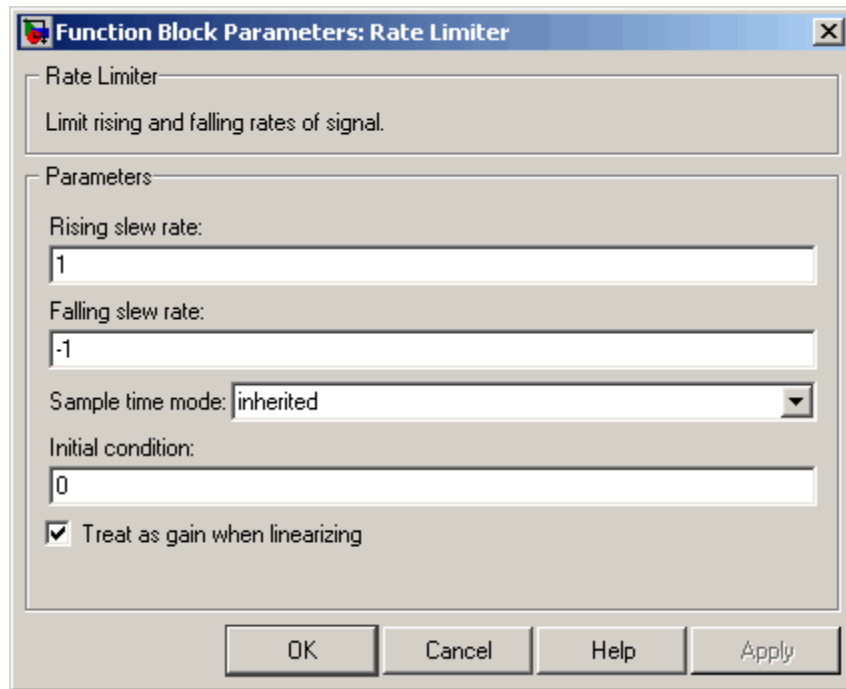

### Rising slew rate

Specify the limit of the derivative of an increasing input signal. This parameter is tunable for fixed-point inputs.

### Falling slew rate

Specify the limit of the derivative of a decreasing input signal. This parameter is tunable for fixed-point inputs.

### Sample time mode

Specify the sample time mode, continuous or inherited from the driving block.

### Initial condition

Set the initial output of the simulation. Simulink does not allow you to set the initial condition of this block to `inf` or `NaN`.



## Treat as gain when linearizing

Linearization commands in Simulink treat this block as a gain in state space. Select this check box to cause the linearization commands to treat the gain as 1; otherwise, the commands treat the gain as 0.

## Characteristics

Direct Feedthrough	Yes
Sample Time	Continuous or inherited (specified in the <b>Sample time mode</b> parameter)
Scalar Expansion	Yes, of input and parameters
Dimensionalized	Yes
Zero Crossing	No

## See Also

Rate Limiter Dynamic

# Rate Limiter Dynamic

**Purpose** Limit rising and falling rates of signal

**Library** Discontinuities

**Description** The Rate Limiter Dynamic block limits the rising and falling rates of the signal.

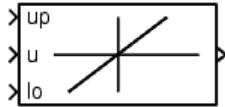

The external signal *up* sets the upper limit on the rising rate of the signal.

The external signal *lo* sets the lower limit on the falling rate of the signal.

---

**Note** You cannot use a variable-step solver to simulate models that contain this block. You must use a fixed-step solver.

---

**Data Type Support** The Rate Limiter Dynamic block accepts signals of any data type supported by Simulink, including fixed-point data types.

## Parameters and Dialog Box

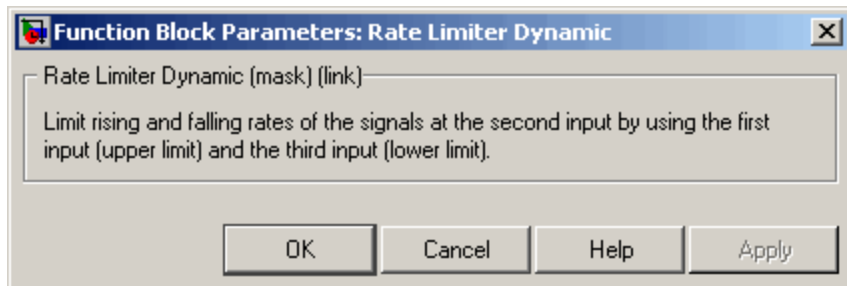

<b>Characteristics</b>	Direct Feedthrough	Yes
	Scalar Expansion	Yes

**See Also** Rate Limiter

**Purpose** Handle transfer of data between blocks operating at different rates

**Library** Signal Attributes

## Description

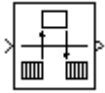

The Rate Transition block transfers data from the output of a block operating at one rate to the input of another block operating at a different rate. The Rate Transition block's parameters allow you to specify options that trade data integrity and deterministic transfer for faster response and/or lower memory requirements.

---

**Note** See “Data Transfer Problems” in the online Real-Time Workshop documentation for a discussion of data integrity and deterministic data transfer.

---

In particular, the block supports the following options:

- Deterministic transfer of data with data integrity between blocks operating at different speeds at the cost of maximum latency of data transfer

This is the default option.

- Nondeterministic data transfer with minimum latency and assured data integrity but increased memory requirements

To specify this option, check the **Ensure data integrity during data transfer** parameter and uncheck the **Ensure deterministic data transfer** parameter.

- Minimum latency and target size at the cost of nondeterministic data transfer and possible loss of data integrity

To specify this option, uncheck the **Ensure data integrity during data transfer** and **Ensure deterministic data transfer** parameters.

# Rate Transition

---

The behavior of the Rate Transition block depends on the sample times of the ports between which it is connected, the priorities of the tasks corresponding to the source and destination sample times (see “Sample time properties”), and whether the model specifies a fixed- or variable-step solver. Updating the diagram causes a label to appear on the block that indicates its behavior during simulation as follows:

Label	Block Behavior
ZOH	Acts as a zero-order hold
1/z	Acts as a unit delay
Buf	Copies input to output under semaphore control
Db_buf	Copies input to output, using double buffers
Copy	Unprotected copy of input to output
NoOp	Does nothing

The behavior label lets you see at a glance the method that the Rate Transition block uses to ensure safe transfer of data between tasks operating at different rates. You can use Simulink’s sample-time colors feature (see “Displaying Sample Time Colors”) to display the relative rates that the block bridges. Consider, for example, the following diagram.

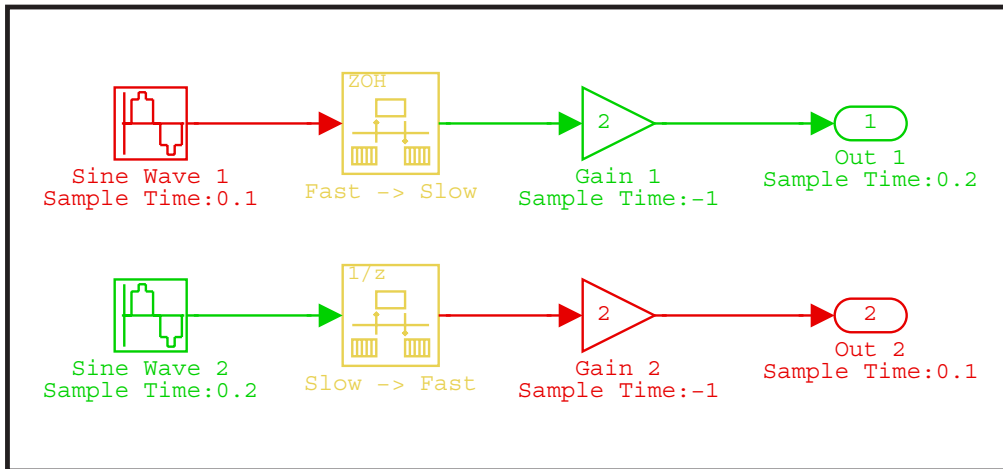

Sample-time colors and the block behavior label allow you to see at a glance that the Rate Transition block at the top of the diagram acts as a zero-order hold in a fast-to-slow transition and the bottom Rate Transition block acts as a unit delay in a slow-to-fast transition.

See “Sample Rate Transitions” in the online Real-Time Workshop documentation for more information.

---

**Note** The Zero-Order Hold and Unit Delay blocks also enable transfer of data between blocks operating at different rates. However, you should use the Rate Transition block for this purpose because it offers a wider range of options and is easier to use.

---

## Data Type Support

The Rate Transition block accepts signals of any data type supported by Simulink, including fixed-point data types.

For a discussion on the data types supported by Simulink, see “Data Types Supported by Simulink” in the Simulink documentation.

# Rate Transition

## Parameters and Dialog Box

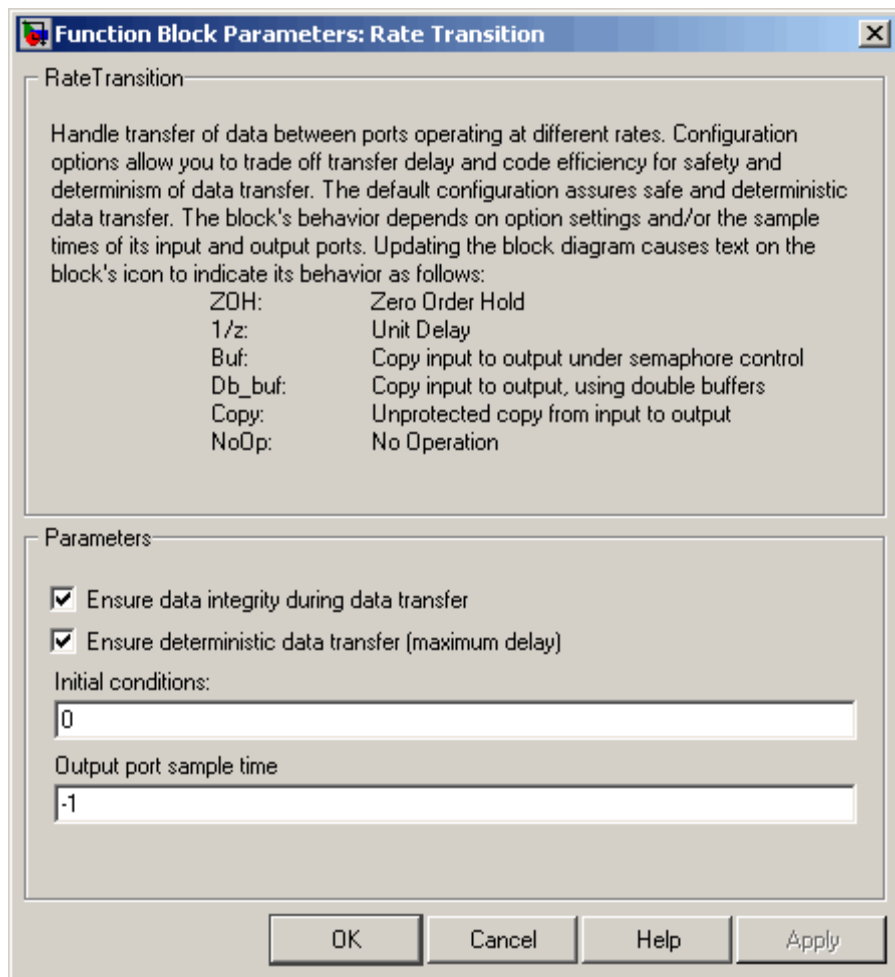

### Ensure data integrity during data transfer

Selecting this option results in generation of code that ensures the integrity of data transferred by the Rate Transition block. If you select this option and the transfer is nondeterministic (see **Ensure deterministic data transfer** option below), the

generated code uses double-buffering to prevent the fast block from interrupting the data transfer. Otherwise the generated code uses a copy operation to effect the data transfer. The copy operation consumes less memory than double-buffering but is also interruptible and hence can lead to loss of data during nondeterministic data transfers. Thus, you should select this option if you want the generated code to operate both with maximum responsiveness (i.e., nondeterministically) and assured data integrity. See “Rate Transition Block Options” in the online Real-Time Workshop documentation for more information.

### **Ensure deterministic data transfer (maximum delay)**

Selecting this option causes code generation to generate code that transfers data at the sample rate of the slower block, i.e., deterministically. If this option is not selected, data transfers occur as soon as new data is available from the source block and the receiving block is ready to receive the data. This avoids the need to delay transfers, thus ensuring that the system operates with maximum responsiveness. However, it also means that transfers can occur unpredictably, which is undesirable in some applications. See “Rate Transition Block Options” in the online Real-Time Workshop documentation for more information.

### **Initial conditions**

This parameter applies only to slow-to-fast transitions. It specifies the Rate Transition’s initial output at the beginning of a transition when there is not yet any output from the slow block connected to the Rate Transition block’s input. Simulink does not allow the initial output of this block to be `inf` or `NaN`.

### **Output port sample time**

Specifies the output rate to which the input rate is converted. The default value (-1) specifies that the output rate is inherited from the block to which the Rate Transition block’s output port is connected. See “Specifying Sample Time” in the online documentation for information on how to specify the output rate.

# Rate Transition

---

## Bus Support

The Rate Transition block is a bus-capable block. The input can be a virtual or nonvirtual bus signal, with the restriction that **Initial conditions** must be zero or a non-zero scalar.

## Characteristics

Bus-capable	Yes, with restrictions as noted above
Direct Feedthrough	No for slow-to-fast transitions that are protected, i.e., for which you have checked the <b>Ensure data integrity during data transfer</b> option. Otherwise, Yes.
Sample Time	This block supports discrete-to-discrete transitions.
Scalar Expansion	Yes, of input.
Dimensionalized	Yes
Multidimensionalized	Yes
Zero Crossing	No



**Purpose** Convert real and/or imaginary inputs to complex signal

**Library** Math Operations

## Description

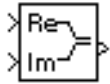

The Real-Imag to Complex block converts real and/or imaginary inputs to a complex-valued output signal.

The inputs can both be arrays (vectors or matrices) of equal dimensions, or one input can be an array and the other a scalar. If the block has an array input, the output is a complex array of the same dimensions. The elements of the real input are mapped to the real parts of the corresponding complex output elements. The imaginary input is similarly mapped to the imaginary parts of the complex output signals. If one input is a scalar, it is mapped to the corresponding component (real or imaginary) of all the complex output signals.

The input signals and real or imaginary output parameter can be of any data type supported by Simulink, except Boolean. The Real-Imag to Complex block supports fixed-point data types. The output is of the same type as the input or parameter that determines the output.

For a discussion on the data types supported by Simulink, see “Data Types Supported by Simulink” in the Simulink documentation.

## Data Type Support

See the preceding description.

# Real-Imag to Complex

## Parameters and Dialog Box

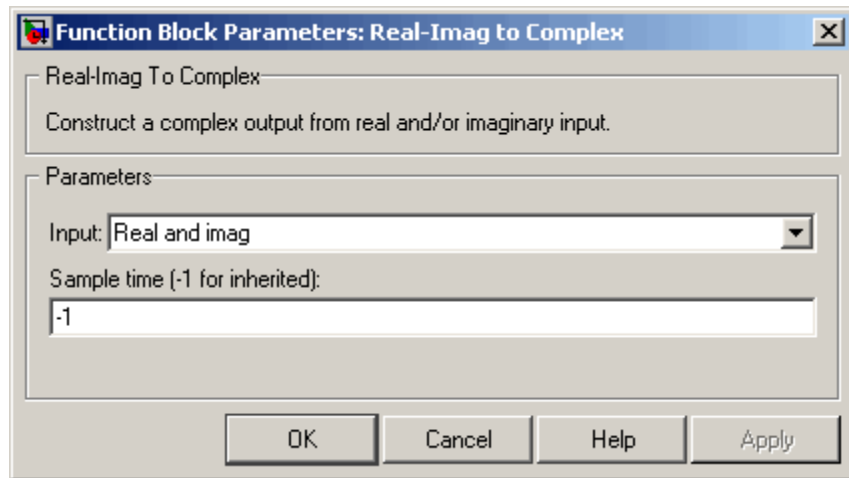

### Input

Specifies the kind of input: a real input, an imaginary input, or both.

### Real (Imag) part

If the input is a real-part signal, this parameter specifies the constant imaginary part of the output signal. If the input is the imaginary part, this parameter specifies the constant real part of the output signal. Note that the title of this field changes to reflect its usage.

### Sample time (-1 for inherited)

Specify the time interval between samples. To inherit the sample time, set this parameter to -1. See “Specifying Sample Time” in the online documentation for more information.

## Characteristics

Direct Feedthrough	Yes
Sample Time	Inherited from driving block

Scalar Expansion	Yes, of the input when the function requires two inputs
Dimensionalized	Yes
Multidimensionalized	Yes
Zero Crossing	No

# Relational Operator

**Purpose** Perform specified relational operation on inputs

**Library** Logic and Bit Operations

**Description** The Relational Operator block performs the specified comparison of its two inputs.

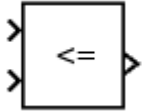

You select the relational operator connecting the two inputs with the **Relational Operator** parameter. The block updates to display the selected operator. The supported operations are given below. In each case, the first input corresponds to the top input port and the second input to the bottom input port. (See “Changing the Orientation of a Block” in Using Simulink for a description of the port order for various block orientations.)

Operation	Description
==	TRUE if the first input is equal to the second input
~=	TRUE if the first input is not equal to the second input
<	TRUE if the first input is less than the second input
<=	TRUE if the first input is less than or equal to the second input
>=	TRUE if the first input is greater than or equal to the second input
>	TRUE if the first input is greater than the second input

You can specify inputs as scalars, arrays, or a combination of a scalar and an array:

- For scalar inputs, the output is a scalar.
- For array inputs, the output is an array of the same dimensions, where each element is the result of an element-by-element comparison of the input arrays.

- For mixed scalar/array inputs, the output is an array, where each element is the result of a comparison between the scalar and the corresponding array element.

The input with the smaller positive range is converted to the data type of the other input offline using round-to-nearest and saturation. This conversion is performed prior to comparison.

The output data type is specified with the **Output data type** parameter. The output equals 1 for TRUE and 0 for FALSE.

---

**Note** The output data type selected should represent zero exactly. Data types that satisfy this condition include signed and unsigned integers and any floating-point data type.

---

## Data Type Support

The Relational Operator block accepts real or complex signals of any data type supported by Simulink, including fixed-point data types. One input can be real and the other complex if the operator is == or !=.

For a discussion on the data types supported by Simulink, see “Data Types Supported by Simulink” in the Simulink documentation.

## Parameters and Dialog Box

The **Main** pane of the Relational Operator block appears as follows:

# Relational Operator

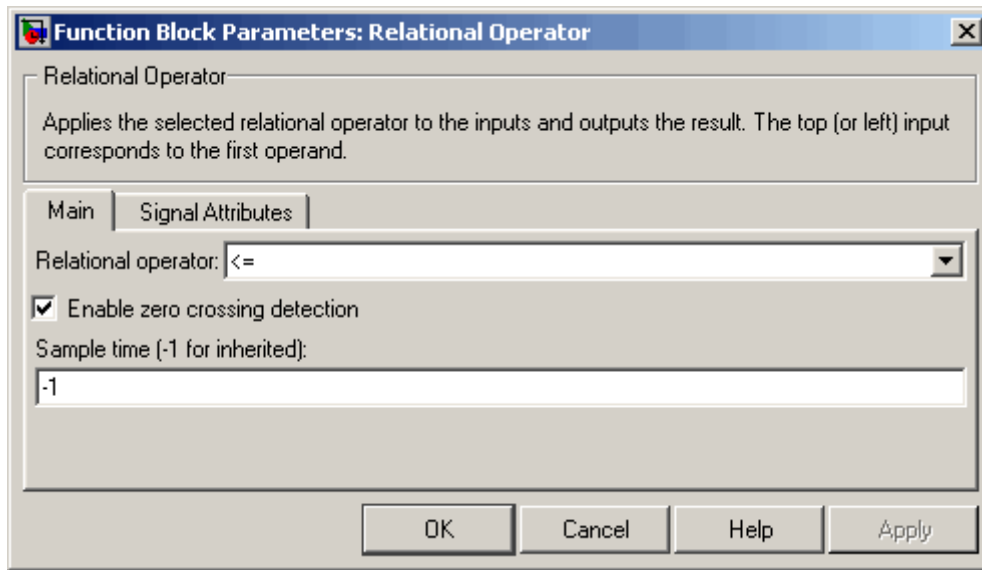

## **Relational operator**

Designate the relational operator used to compare the two inputs.

## **Enable zero crossing detection**

Select to enable zero crossing detection. For more information, see “Zero-Crossing Detection” in the “How Simulink Works” chapter of the Using Simulink documentation.

## **Sample time (-1 for inherited)**

Specify the time interval between samples. To inherit the sample time, set this parameter to -1. See “Specifying Sample Time” in the online documentation for more information.

The **Signal Attributes** pane of the Relational Operator block appears as follows:

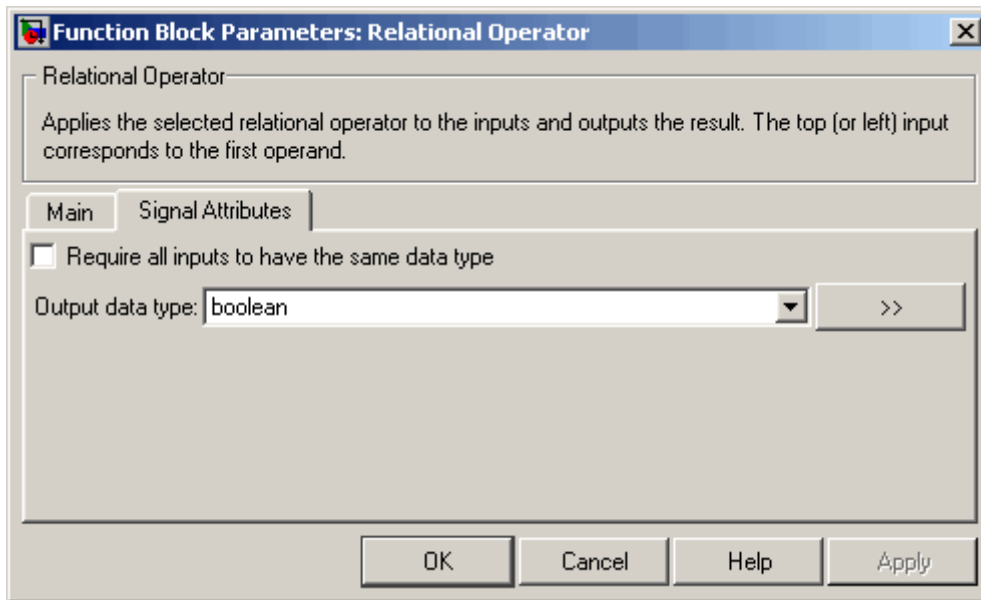

**Require all inputs to have the same data type**

Select to require inputs to have the same data type.

**Output data type**

Specify the output data type. You can set it to:

# Relational Operator

Option	Description
boolean	Specifies the output data type as boolean.
Inherit: Logical	Use the <b>Implement logic signals as boolean data</b> model configuration parameter (see “Implement logic signals as boolean data (vs. double)”) to specify the output data type.  <b>Note</b> This option is intended to support models created before the boolean option became available. Use one of the other options, preferably boolean, for new models.

Click the **Show data type assistant** button  to display the **Data Type Assistant**, which helps you set the **Output data type** parameter.

See “Specifying Block Output Data Types” in *Using Simulink* for more information.

## Characteristics

Direct Feedthrough	Yes
Sample Time	Specified in the <b>Sample time</b> parameter
Scalar Expansion	Yes, of inputs
Dimensionalized	Yes
Multidimensionalized	Yes
Zero Crossing	Yes, if enabled.



<b>Purpose</b>	Switch output between two constants
<b>Library</b>	Discontinuities
<b>Description</b>	<p>The Relay block allows its output to switch between two specified values. When the relay is on, it remains on until the input drops below the value of the <b>Switch off point</b> parameter. When the relay is off, it remains off until the input exceeds the value of the <b>Switch on point</b> parameter. The block accepts one input and generates one output.</p> <p>The <b>Switch on point</b> value must be greater than or equal to the <b>Switch off point</b>. Specifying a <b>Switch on point</b> value greater than the <b>Switch off point</b> value models hysteresis, whereas specifying equal values models a switch with a threshold at that value.</p>
<b>Data Type Support</b>	<p>The Relay block accepts real or complex signals of any data type supported by Simulink. The Relay block supports fixed-point data types.</p> <p>For a discussion on the data types supported by Simulink, see “Data Types Supported by Simulink” in the Simulink documentation.</p>

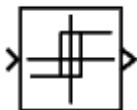

# Relay

## Parameters and Dialog Box

The **Main** pane of the Relay block dialog appears as follows:

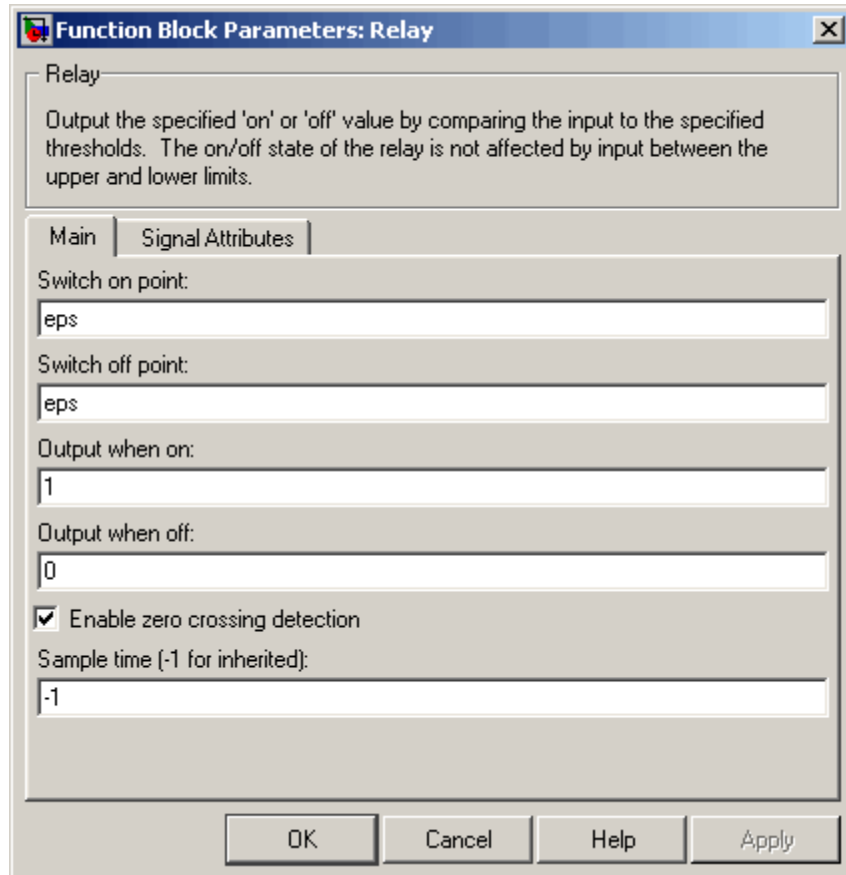

### Switch on point

The “n” threshold for the relay. The **Switch on point** parameter is converted to the input data type offline using round-to-nearest and saturation.

**Switch off point**

The “off” threshold for the relay. The **Switch off point** parameter is converted to the input data type offline using round-to-nearest and saturation.

**Output when on**

The output when the relay is on.

**Output when off**

The output when the relay is off.

**Enable zero crossing detection**

Select to enable zero crossing detection to detect switch-on and switch-off points. For more information, see “Zero-Crossing Detection” in the “How Simulink Works” chapter of the Using Simulink documentation.

**Sample time (-1 for inherited)**

Specify the time interval between samples. To inherit the sample time, set this parameter to -1. See “Specifying Sample Time” in the online documentation for more information.

The **Signal Attributes** pane of the Relay block dialog appears as follows:

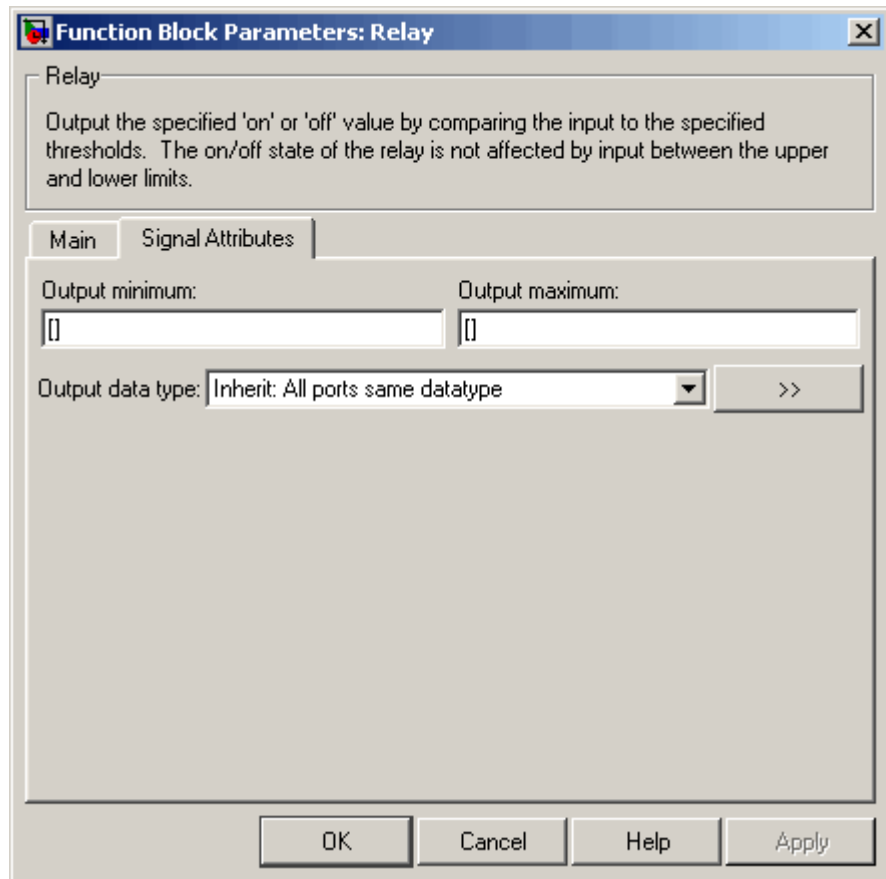

## Output minimum

Specify the minimum value that the block should output. The default value, [ ], is equivalent to  $-\infty$ . Simulink uses this value to perform:

- Parameter range checking (see “Checking Parameter Values”)
- Simulation range checking (see “Checking Signal Ranges”)
- Automatic scaling of fixed-point data types

**Output maximum**

Specify the maximum value that the block should output. The default value, [], is equivalent to Inf. Simulink uses this value to perform:

- Parameter range checking (see “Checking Parameter Values”)
- Simulation range checking (see “Checking Signal Ranges”)
- Automatic scaling of fixed-point data types

**Output data type**

Specify the output data type. You can set it to:

- A rule that inherits a data type, for example, Inherit:  
Inherit via back propagation
- The name of a built-in data type, for example, single
- The name of a data type object, for example, a Simulink.NumericType object
- An expression that evaluates to a data type, for example, float('single')

Click the **Show data type assistant** button  to display the **Data Type Assistant**, which helps you set the **Output data type** parameter.

See “Specifying Block Output Data Types” in *Using Simulink* for more information.

**Characteristics**

Direct Feedthrough	Yes
Sample Time	Specified in the <b>Sample time</b> parameter
Scalar Expansion	Yes

# Relay

---

Dimensionalized	Yes
Zero Crossing	Yes, if enabled.

**Purpose** Generate arbitrarily shaped periodic signal

**Library** Sources

## Description



The Repeating Sequence block outputs a periodic scalar signal having a waveform that you specify. You can specify any waveform, using the block dialog's **Time values** and **Output values** parameters. The **Times value** parameter specifies a vector of sample times. The **Output values** parameter specifies a vector of signal amplitudes at the corresponding sample times. Together, the two parameters specify a sampling of the output waveform at points measured from the beginning of the interval over which the waveform repeats (i.e., the signal's period). For example, by default, the **Time values** and **Output values** parameters are both set to  $[0 \ 2]$ . This default setting specifies a sawtooth waveform that repeats every 2 seconds from the start of the simulation and has a maximum amplitude of 2. The Repeating Sequence block uses linear interpolation to compute the value of the waveform between the specified sample points.

## Data Type Support

The Repeating Sequence block outputs real signals of type double.

# Repeating Sequence

## Parameters and Dialog Box

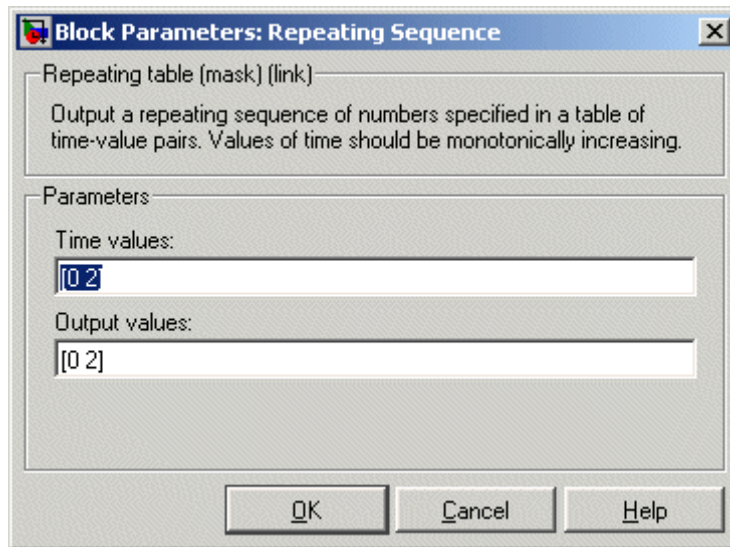

Opening this dialog box causes a running simulation to pause. See “Changing Source Block Parameters During Simulation” in the online Simulink documentation for details.

### Time values

A vector of monotonically increasing time values. The default is [0 2].

### Output values

A vector of output values. Each corresponds to the time value in the same column. The default is [0 2].

## Characteristics

Sample Time	Continuous
Scalar Expansion	No
Dimensionalized	No
Zero Crossing	No



**See Also**

Repeating Sequence Interpolated, Repeating Sequence Stair

# Repeating Sequence Interpolated

---

**Purpose** Output discrete-time sequence and repeat, interpolating between data points

**Library** Sources

**Description** The Repeating Sequence Interpolated block outputs a discrete-time sequence and then repeats it. Between data points, the block uses the method specified by the **Lookup Method** parameter to determine the output.



**Data Type Support** The Repeating Sequence Interpolated block accepts signals of any data type supported by Simulink, including fixed-point data types.

# Repeating Sequence Interpolated

## Parameters and Dialog Box

The **Main** pane of the Repeating Sequence Interpolated block dialog appears as follows:

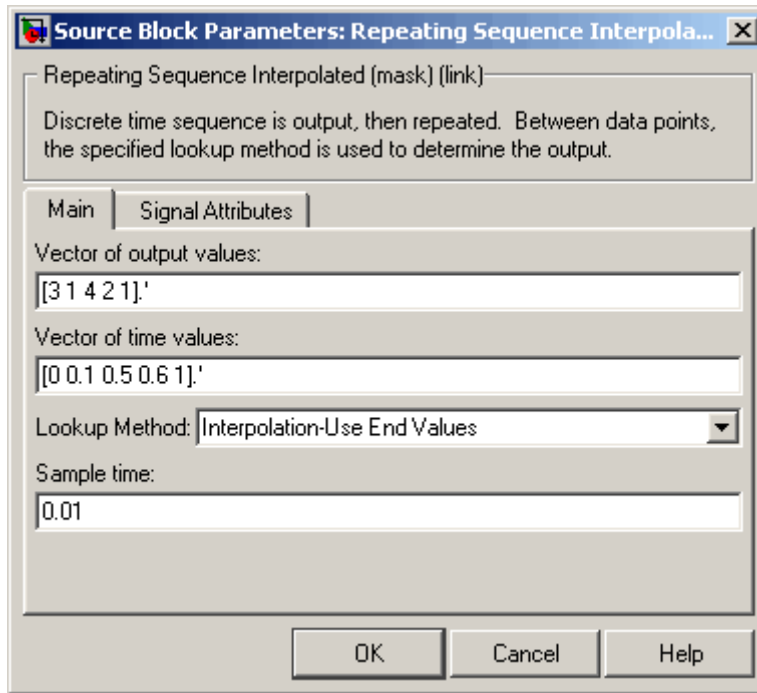

### Vector of output values

Column vector containing output values of the discrete time sequence.

### Vector of time values

Column vector containing time values. The time values must be a strictly increasing and the vector must have the same size as the vector of output values.

### Lookup Method

Specify the lookup method to determine the output between data points.

# Repeating Sequence Interpolated

## Sample time

Specify the time interval between samples. To inherit the sample time, set this parameter to -1. See “Specifying Sample Time” in the online documentation for more information.

The **Signal Attributes** pane of the Repeating Sequence Interpolated block dialog appears as follows:

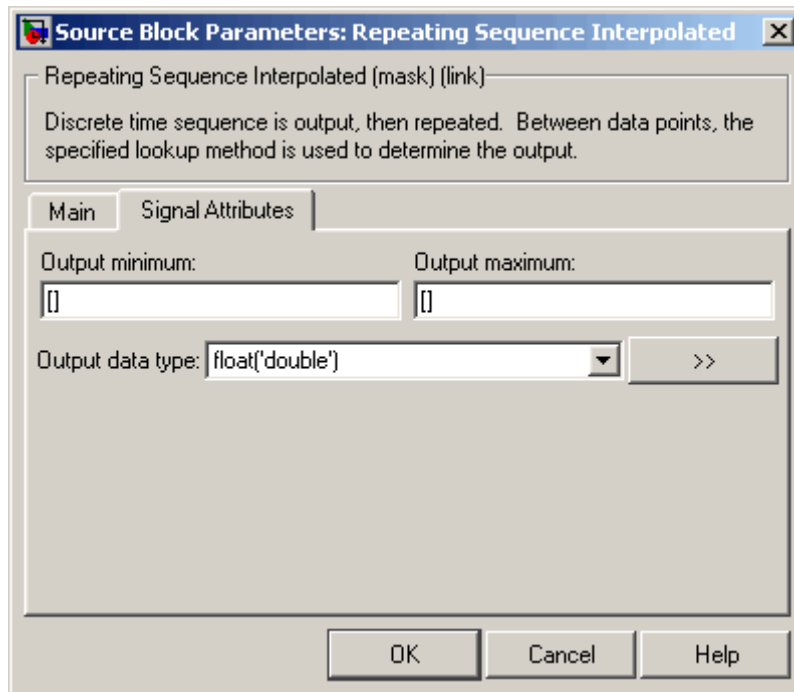

## Output minimum

Specify the minimum value that the block should output. The default value, [], is equivalent to  $-\infty$ . Simulink uses this value to perform:

- Parameter range checking (see “Checking Parameter Values”)

- Simulation range checking (see “Checking Signal Ranges”)
- Automatic scaling of fixed-point data types

## **Output maximum**

Specify the maximum value that the block should output. The default value, [], is equivalent to Inf. Simulink uses this value to perform:

- Parameter range checking (see “Checking Parameter Values”)
- Simulation range checking (see “Checking Signal Ranges”)
- Automatic scaling of fixed-point data types

## **Output data type**

Specify the output data type. You can set it to:

- A rule that inherits a data type, for example, Inherit:  
Inherit via back propagation
- The name of a built-in data type, for example, single
- The name of a data type object, for example, a Simulink.NumericType object
- An expression that evaluates to a data type, for example, float('single')

Click the **Show data type assistant** button  to display the **Data Type Assistant**, which helps you set the **Output data type** parameter.

See “Specifying Block Output Data Types” in *Using Simulink* for more information.

## **Lock output scaling against changes by the autoscaling tool**

Select to lock scaling of outputs. This parameter is visible only if you enter an expression for the **Output data type** parameter.

# Repeating Sequence Interpolated

---

<b>Characteristics</b>	Sample Time	Specified in the <b>Sample time</b> parameter
	Scalar Expansion	Yes

**See Also**      Repeating Sequence, Repeating Sequence Stair

# Repeating Sequence Stair

**Purpose** Output and repeat discrete time sequence

**Library** Sources

**Description** The Repeating Sequence Stair block outputs and repeats a discrete time sequence.



You can specify the stair sequence with the **Vector of output values** parameter. For example, the vector can be specified as `[3 1 2 4 1]'`, producing the stair sequence shown in the plot.

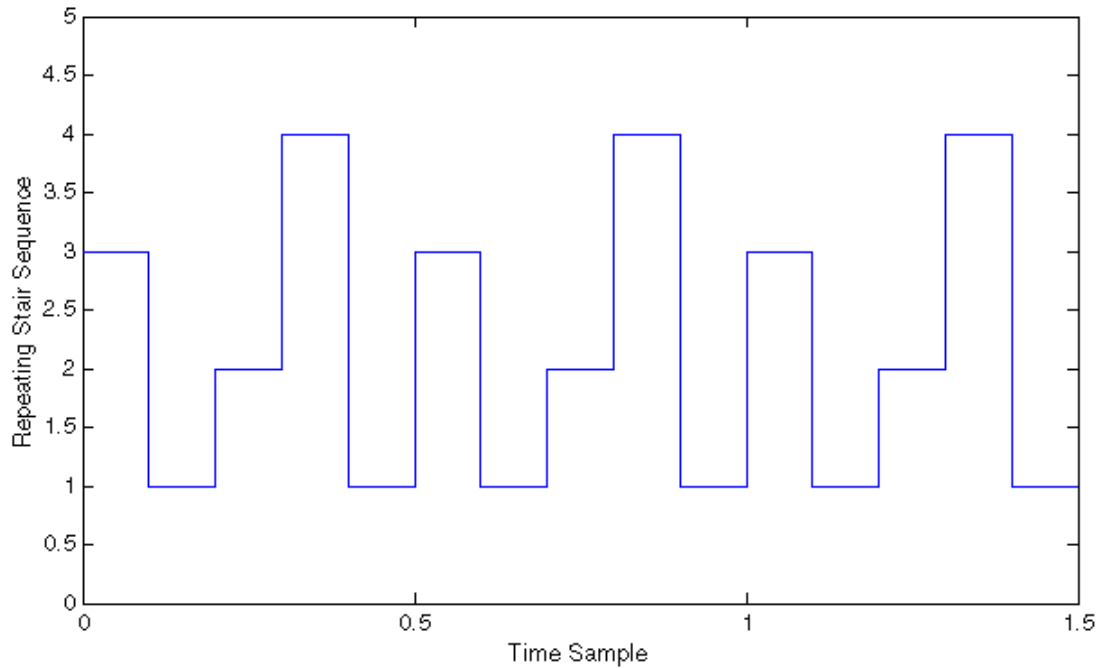

**Data Type Support** The Repeating Sequence Stair block accepts signals of any data type supported by Simulink, including fixed-point data types.

# Repeating Sequence Stair

---

## Parameters and Dialog Box

The **Main** pane of the Repeating Sequence Stair block dialog appears as follows:

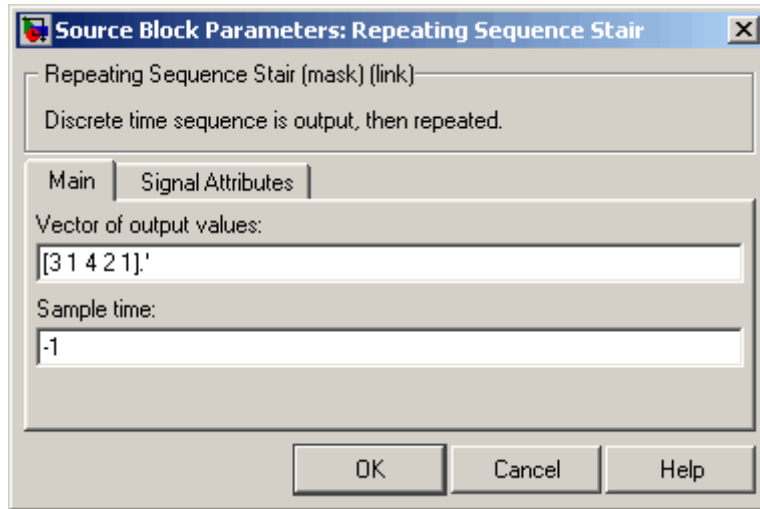

### Vector of output values

Vector containing values of the repeating stair sequence.

### Sample time

Specify the time interval between samples. To inherit the sample time, set this parameter to -1. See “Specifying Sample Time” in the online documentation for more information.

The **Signal Attributes** pane of the Repeating Sequence Stair block dialog appears as follows:



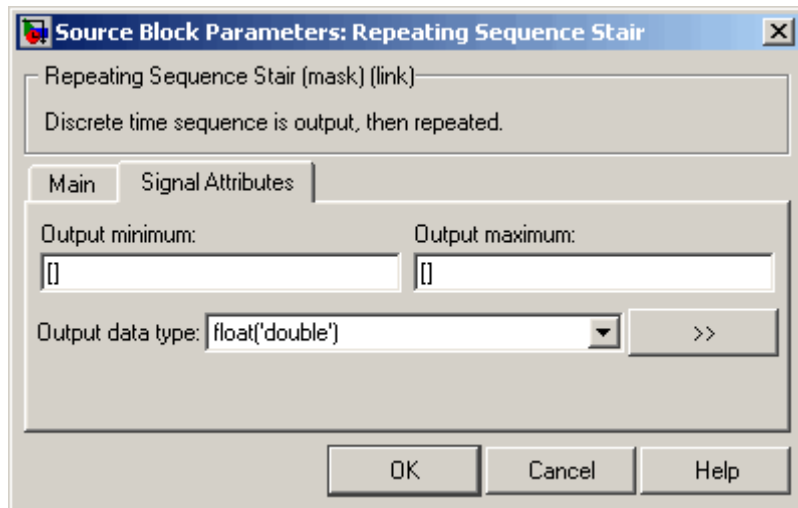

## Output minimum

Specify the minimum value that the block should output. The default value, [], is equivalent to  $-\text{Inf}$ . Simulink uses this value to perform:

- Parameter range checking (see “Checking Parameter Values”)
- Simulation range checking (see “Checking Signal Ranges”)
- Automatic scaling of fixed-point data types

## Output maximum

Specify the maximum value that the block should output. The default value, [], is equivalent to  $\text{Inf}$ . Simulink uses this value to perform:

- Parameter range checking (see “Checking Parameter Values”)
- Simulation range checking (see “Checking Signal Ranges”)
- Automatic scaling of fixed-point data types

## Output data type

Specify the output data type. You can set it to:

# Repeating Sequence Stair

---

- A rule that inherits a data type, for example, `Inherit: Inherit` via back propagation
- The name of a built-in data type, for example, `single`
- The name of a data type object, for example, a `Simulink.NumericType` object
- An expression that evaluates to a data type, for example, `float('single')`

Click the **Show data type assistant** button  to display the **Data Type Assistant**, which helps you set the **Output data type** parameter.

See “Specifying Block Output Data Types” in *Using Simulink* for more information.

## **Lock output scaling against changes by the autoscaling tool**

Select to lock scaling of outputs. This parameter is visible only if you enter an expression for the **Output data type** parameter.

## **Characteristics**

Sample Time	Specified in the <b>Sample time</b> parameter
Scalar Expansion	No

## **See Also**

Repeating Sequence, Repeating Sequence Interpolated

**Purpose** Change dimensionality of signal

**Library** Math Operations

### Description



The Reshape block changes the dimensionality of the input signal to a dimensionality that you specify, using the block's **Output dimensionality** parameter. For example, you can use the block to change an N-element vector to a 1-by-N or N-by-1 matrix signal, and vice versa.

The **Output dimensionality** parameter lets you select any of the following output options.

Output Dimensionality	Description
1-D array	Converts a multidimensional array to a vector (1-D array) array signal. The output vector consists of the first column of the input matrix followed by the second column, etc. (This option leaves a vector input unchanged.)
Column vector	Converts a vector, matrix, or multidimensional input signal to a column matrix, i.e., an M-by-1 matrix, where M is the number of elements in the input signal. For matrices, the conversion is done in column-major order. For multidimensional arrays, the conversion is done along the first dimension.

# Reshape

---

Output Dimensionality	Description
Row vector	Converts a vector, matrix, or multidimensional input signal to a row matrix, i.e., a 1-by-N matrix where N is the number of elements in the input signal. For matrices, the conversion is done in column-major order. For multidimensional arrays, the conversion is done along the first dimension.
Customize	Converts the input signal to an output signal whose dimensions you specify, using the <b>Output dimensions</b> parameter. The value of the <b>Output dimensions</b> parameter can be a one- or multi-element vector. A value of [N] outputs a vector of size N. A value of [M N] outputs an M-by-N matrix. The number of elements of the input signal must match the number of elements specified by the <b>Output dimensions</b> parameter. For multidimensional arrays, the conversion is done along the first dimension.

## Data Type Support

The Reshape block accepts and outputs signals of any data type supported by Simulink, including fixed-point data types.

For a discussion on the data types supported by Simulink, see “Data Types Supported by Simulink” in the Simulink documentation.

## Parameters and Dialog Box

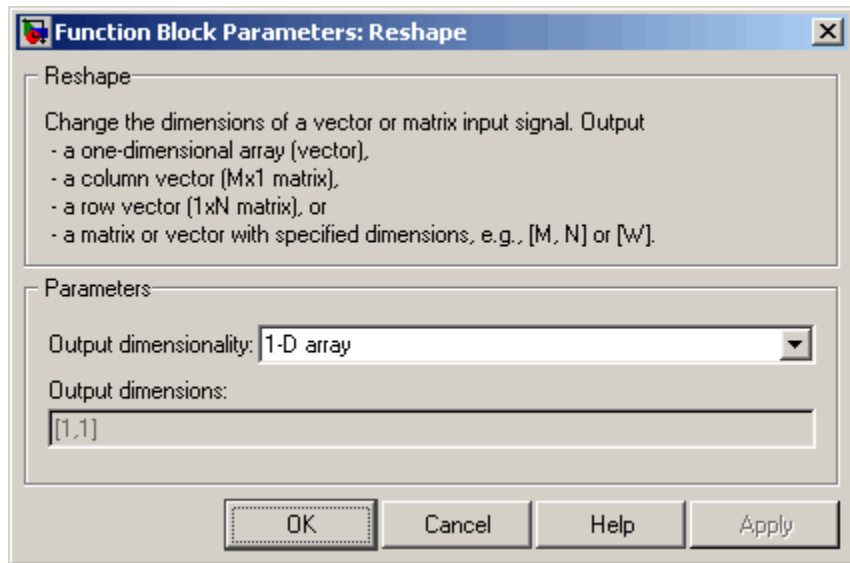

### Output dimensionality

The dimensionality of the output signal.

### Output dimensions

Specifies a custom output dimensionality. This option is enabled only if you select Customize as the value of the **Output dimensionality** parameter.

## Characteristics

Direct Feedthrough	Yes
Sample Time	Inherited from driving block
Scalar Expansion	N/A
Dimensionalized	Yes
Multidimensionalized	Yes
Zero Crossing	No

# Rounding Function

---

**Purpose** Apply rounding function to signal

**Library** Math Operations

**Description** The Rounding Function block applies a rounding function to the input signal to produce the output signal.



You can select one of the following rounding functions from the **Function** list:

- `floor`  
Rounds each element of the input signal to the nearest integer value towards minus infinity.
- `ceil`  
Rounds each element of the input signal to the nearest integer towards positive infinity.
- `round`  
Rounds each element of the input signal to the nearest integer.
- `fix`  
Rounds each element of the input signal to the nearest integer towards zero.

The name of the selected function appears on the block.

The input signal can be a scalar, vector, or matrix signal having real- or complex-valued elements of type `double`. The output signal has the same dimensions, data type, and numeric type as the input. Each element of the output signal is the result of applying the selected rounding function to the corresponding element of the input signal.

Use the Rounding Function block instead of the `Fcn` block when you want vector or matrix output, because the `Fcn` block can produce only scalar output.

## Data Type Support

The Rounding Function block accepts and outputs real signals of type double or single.

## Parameters and Dialog Box

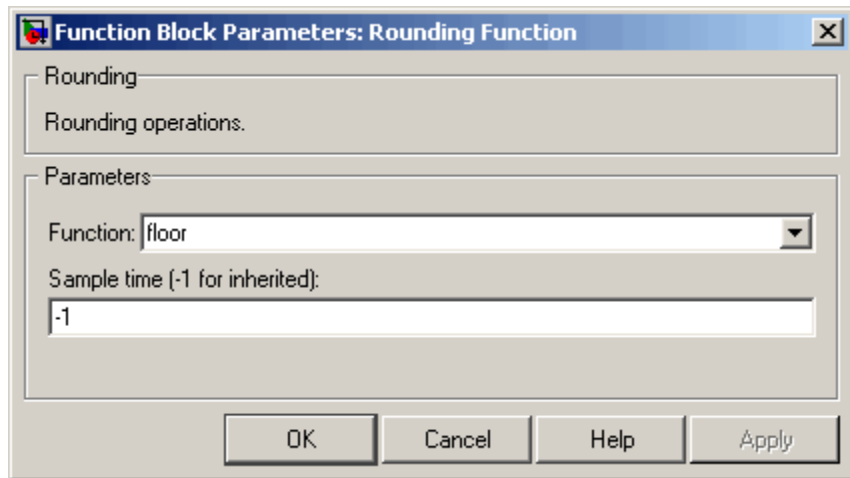

## Function

The rounding function.

## Sample time (-1 for inherited)

Specify the time interval between samples. To inherit the sample time, set this parameter to -1. See “Specifying Sample Time” in the online documentation for more information.

## Characteristics

Direct Feedthrough	Yes
Sample Time	Inherited from driving block
Scalar Expansion	N/A
Dimensionalized	Yes
Zero Crossing	No

# Saturation

---

**Purpose** Limit range of signal

**Library** Discontinuities

## Description

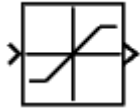

The Saturation block imposes upper and lower bounds on a signal. When the input signal is within the range specified by the **Lower limit** and **Upper limit** parameters, the input signal passes through unchanged. When the input signal is outside these bounds, the signal is clipped to the upper or lower bound.

When the **Lower limit** and **Upper limit** parameters are set to the same value, the block outputs that value.

## Data Type Support

The Saturation block accepts real signals of any data type supported by Simulink, except `Boolean`. The Saturation block supports fixed-point data types.

For a discussion on the data types supported by Simulink, see “Data Types Supported by Simulink” in the Simulink documentation.



## Parameters and Dialog Box

The **Main** pane of the Saturation block dialog appears as follows:

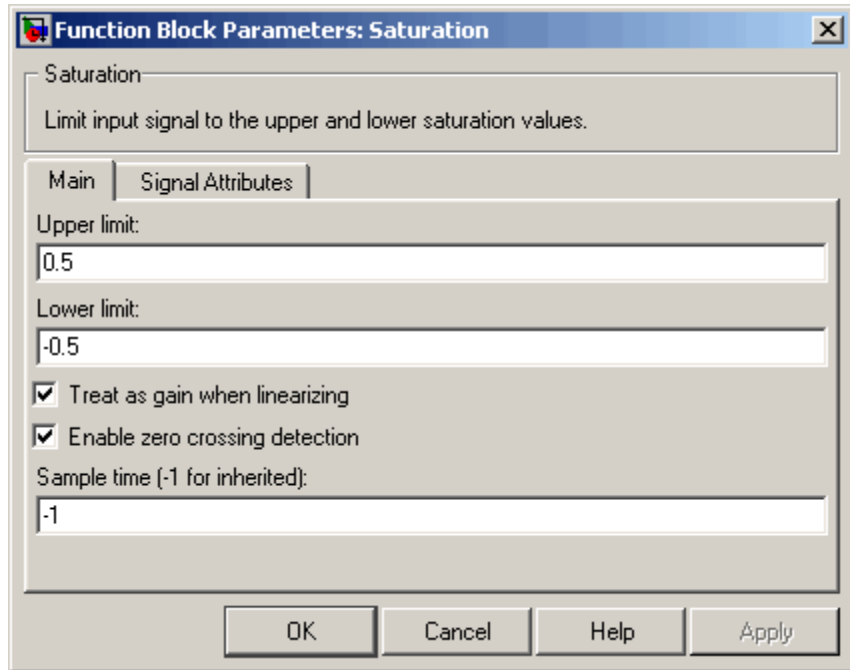

### Upper limit

Specify the upper bound on the input signal. When the input signal to the Saturation block is above this value, the output of the block is clipped to this value.

The **Upper limit** parameter is converted to the input data type offline using round-to-nearest and saturation.

### Lower limit

Specify the lower bound on the input signal. When the input signal to the Saturation block is below this value, the output of the block is clipped to this value.

# Saturation

---

The **Lower limit** parameter is converted to the input data type offline using round-to-nearest and saturation.

## **Treat as gain when linearizing**

Linearization commands in Simulink treat this block as a gain in state space. Select this parameter to cause the linearization commands to treat the gain as 1; otherwise, the commands treat the gain as 0.

## **Enable zero crossing detection**

Select to enable zero crossing detection. For more information, see “Zero-Crossing Detection” in the “How Simulink Works” chapter of Using Simulink.

## **Sample time (-1 for inherited)**

Specify the time interval between samples. To inherit the sample time, set this parameter to -1. See “Specifying Sample Time” in the online documentation for more information.

The **Signal Attributes** pane of the Saturation block dialog appears as follows:

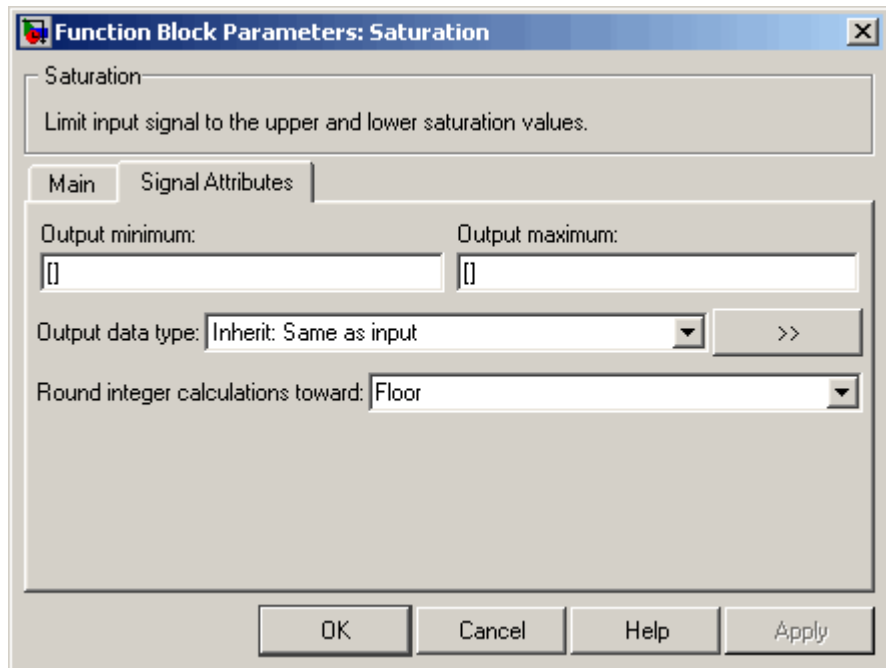

### Output minimum

Specify the minimum value that the block should output. The default value, [], is equivalent to  $-\infty$ . Simulink uses this value to perform:

- Parameter range checking (see “Checking Parameter Values”)
- Simulation range checking (see “Checking Signal Ranges”)
- Automatic scaling of fixed-point data types

### Output maximum

Specify the maximum value that the block should output. The default value, [], is equivalent to  $\infty$ . Simulink uses this value to perform:

- Parameter range checking (see “Checking Parameter Values”)

# Saturation

---

- Simulation range checking (see “Checking Signal Ranges”)
- Automatic scaling of fixed-point data types

## Output data type

Specify the output data type. You can set it to:

- A rule that inherits a data type, for example, `Inherit: Inherit via back propagation`
- The name of a built-in data type, for example, `single`
- The name of a data type object, for example, a `Simulink.NumericType` object
- An expression that evaluates to a data type, for example, `float('single')`

Click the **Show data type assistant** button  to display the **Data Type Assistant**, which helps you set the **Output data type** parameter.

See “Specifying Block Output Data Types” in *Using Simulink* for more information.

## Lock output scaling against changes by the autoscaling tool

Select to lock scaling of outputs. This parameter is visible only if you enter an expression for the **Output data type** parameter.

## Round integer calculations toward

Select the rounding mode for fixed-point operations.

## Characteristics

Direct Feedthrough	Yes
Sample Time	Specified in the <b>Sample time</b> parameter
Scalar Expansion	Yes, of parameters and input
Dimensionalized	Yes
Zero Crossing	Yes, if enabled.

## **See Also**

Saturation Dynamic

# Saturation Dynamic

---

**Purpose** Bound range of input

**Library** Discontinuities

## Description

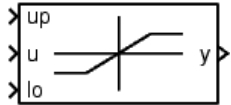

The Saturation Dynamic block bounds the range of the input signal to upper and lower saturation values. The input signal outside of these limits saturates to one of the bounds where

- The input below the lower limit is set to the lower limit.
- The input above the upper limit is set to the upper limit.

The input for the upper limit is the up port, and the input for the lower limit is the lo port.

## Data Type Support

The Saturation Dynamic block accepts signals of any data type supported by Simulink, including fixed-point data types.

For a discussion on the data types supported by Simulink, see “Data Types Supported by Simulink” in the Simulink documentation.

## Parameters and Dialog Box

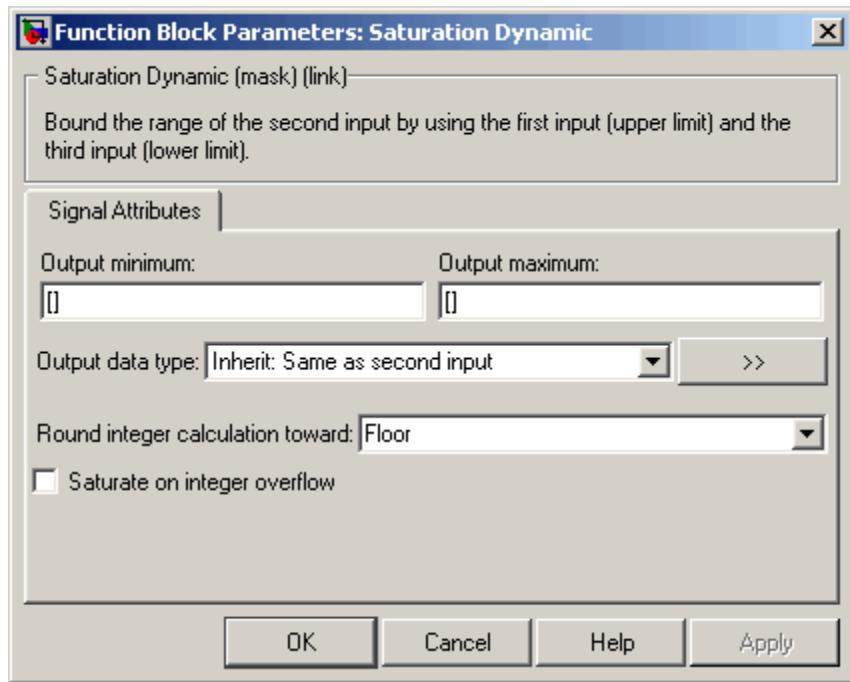

### Output minimum

Specify the minimum value that the block should output. The default value, [], is equivalent to  $-\text{Inf}$ . Simulink uses this value to perform:

- Simulation range checking (see “Checking Signal Ranges”)
- Automatic scaling of fixed-point data types

### Output maximum

Specify the maximum value that the block should output. The default value, [], is equivalent to  $\text{Inf}$ . Simulink uses this value to perform:

- Simulation range checking (see “Checking Signal Ranges”)
- Automatic scaling of fixed-point data types

# Saturation Dynamic

---

## Output data type

Specify the output data type. You can set it to:

- A rule that inherits a data type, for example, `Inherit: Same as second input`
- The name of a built-in data type, for example, `single`
- The name of a data type object, for example, a `Simulink.NumericType` object
- An expression that evaluates to a data type, for example, `float('single')`

Click the **Show data type assistant** button  to display the **Data Type Assistant**, which helps you set the **Output data type** parameter.

See “Specifying Block Output Data Types” in *Using Simulink* for more information.

## Lock output scaling against changes by the autoscaling tool

Select to lock scaling of outputs. This parameter is visible only if you enter an expression for the **Output data type** parameter.

## Round integer calculations toward

Select the rounding mode for fixed-point operations.

## Saturate on integer overflow

Select to have overflows saturate.

## Characteristics

Direct Feedthrough	Yes
Scalar Expansion	Yes

## See Also

Saturation



# Scope, Floating Scope, Signal Viewer Scope

---

**Purpose** Display signals generated during simulation

**Library** Sinks

## Description



The Scope block displays its input with respect to simulation time. The Scope block can have multiple axes (one per port); all axes have a common time range with independent  $y$ -axes. The Scope allows you to adjust the amount of time and the range of input values displayed. You can move and resize the Scope window and you can modify the Scope's parameter values during the simulation.

When you start a simulation, Simulink does not open Scope windows, although it does write data to connected Scopes. As a result, if you open a Scope after a simulation, the Scope's input signal or signals will be displayed.

If the signal is continuous, the Scope produces a point-to-point plot. If the signal is discrete, the Scope produces a stair-step plot.

The Scope provides toolbar buttons that enable you to zoom in on displayed data, display all the data input to the Scope, preserve axis settings from one simulation to the next, limit data displayed, and save data to the workspace. The toolbar buttons are labeled in this figure, which shows the Scope window as it appears when you open a Scope block.

# Scope, Floating Scope, Signal Viewer Scope

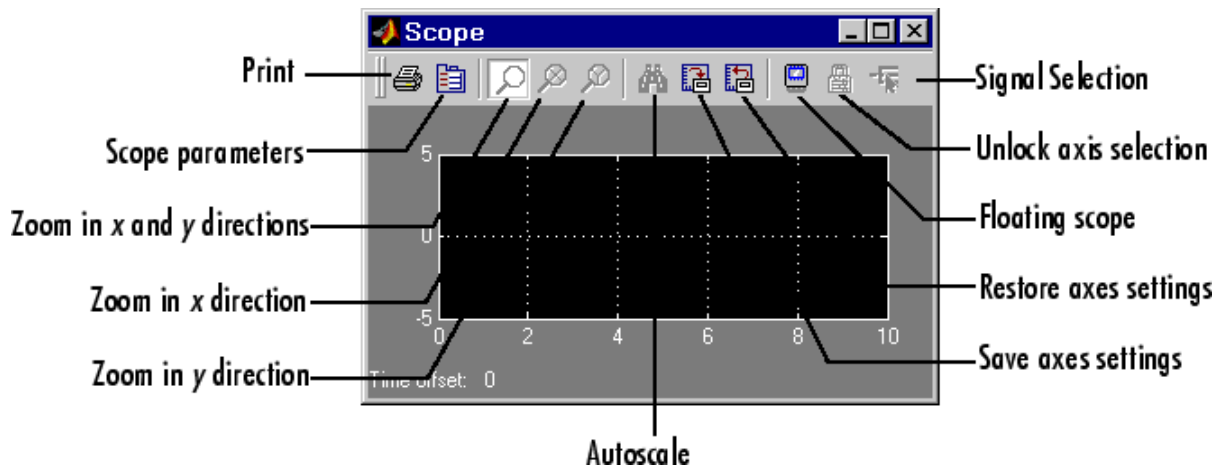

---

**Note** Do not use Scope blocks inside library blocks that you create. Instead, provide the library blocks with output ports to which scopes can be connected to display internal data.

---

## Displaying Multiple Signals on a Single Axis

The Simulink Scope block and Scope viewer differ in their ability to display multiple signals on a single axis. The Scope block can display only one signal per axis, but the Scope viewer can display multiple signals on a single axis.

## Displaying Signals with the Scope Viewer

The Scope viewer displays each signal as a separate, color-coded trace, in the following order:

- 1 Blue
- 2 Red
- 3 Magenta

# Scope, Floating Scope, Signal Viewer Scope

**4** Cyan

**5** Yellow

**6** Green

The viewer cycles through the colors if the axis is displaying more than six signals.

If a signal contains multiple elements (such as a vector or matrix), the viewer distinguishes the elements with different line styles. If a signal has more than six elements the viewer cycles through the line styles. The line styles retain the color of the signal.

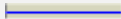
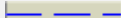
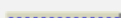
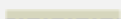
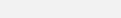
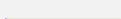
Signal Element	Scope Viewer
1	
2	
3	
4	
5	
6	

## Displaying Multiple Signals with the Scope Block

When displaying a vector or matrix signal on the same axis, the Scope block assigns colors to each signal element, in this order:

**1** Yellow

# Scope, Floating Scope, Signal Viewer Scope

---

2 Magenta

3 Cyan

4 Red

5 Green

6 Dark Blue

The Scope block cycles through the colors if a signal has more than six elements.

## Y-Axis Limits

You set *y*-limits by right-clicking an axis and choosing **Axes Properties**. The following dialog box appears.

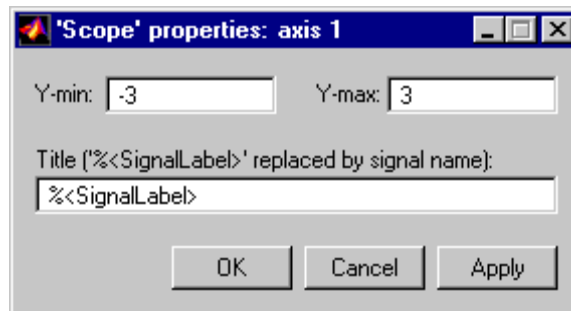

### Y-min

Enter the minimum value for the *y*-axis.

### Y-max

Enter the maximum value for the *y*-axis.

### Title

Enter the title of the plot. You can include a signal label in the title by typing %<SignalLabel> as part of the title string (%<SignalLabel> is replaced by the signal label).

## Time Offset

This figure shows the Scope block displaying the output of the vdp model. The simulation was run for 40 seconds. Note that this scope shows the final 20 seconds of the simulation. The **Time offset** field displays the time corresponding to 0 on the horizontal axis. Thus, you have to add the offset to the fixed time range values on the  $x$ -axis to get the actual time.

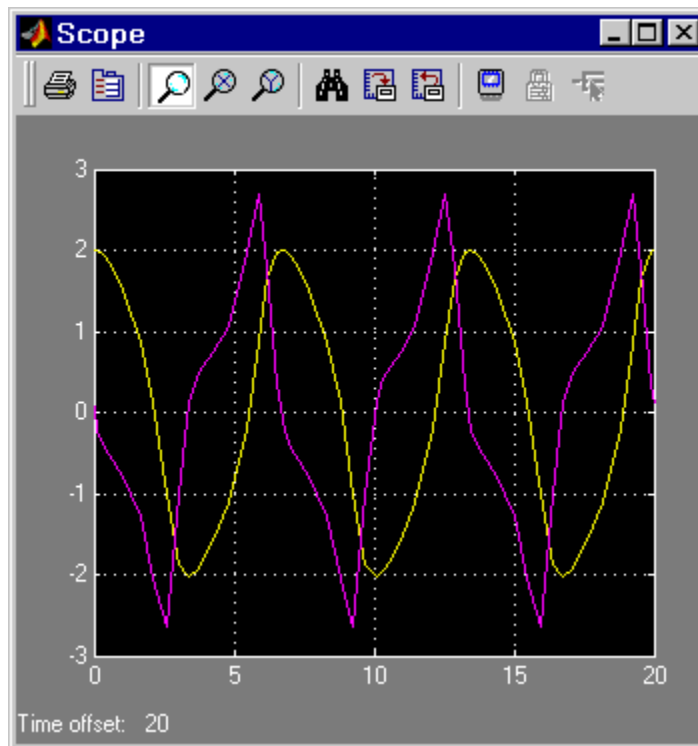

## Autoscaling the Scope Axes

This figure shows the same output after you click the **Autoscale** toolbar button, which automatically scales both axes to display all stored

# Scope, Floating Scope, Signal Viewer Scope

simulation data. In this case, the  $y$ -axis was not scaled because it was already set to the appropriate limits.

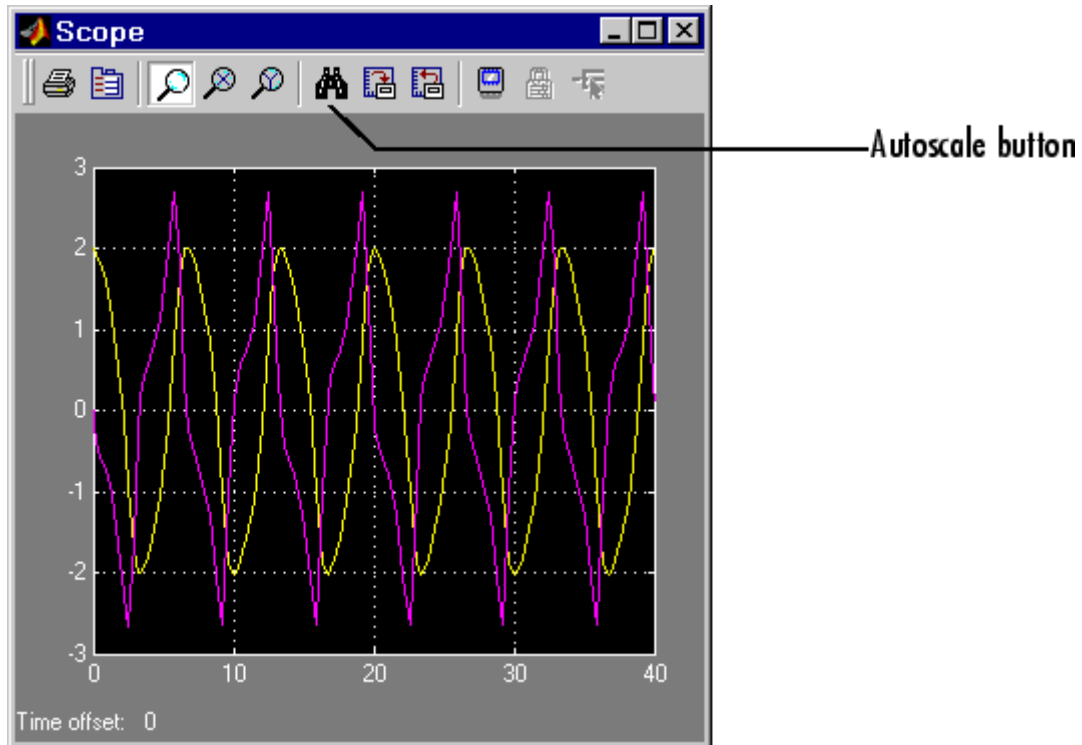

If you click the **Autoscale** button while the simulation is running, the axes are autoscaled based on the data displayed on the current screen, and the autoscale limits are saved as the defaults. This enables you to use the same limits for another simulation.

---

**Note** Simulink does not buffer the data that it displays on a floating Scope. It can therefore scale the contents of a floating Scope only when data is being displayed, i.e., when a simulation is running. When a simulation is not running, Simulink disables (grays) the **Zoom** button on the toolbar of a floating Scope to indicate that it cannot scale its contents.

---

## Zooming

You can zoom in on data in both the  $x$  and  $y$  directions at the same time, or in either direction separately. The zoom feature is not active while the simulation is running.

To zoom in on data in both directions at the same time, make sure you select the leftmost **Zoom** toolbar button. Then, define the zoom region using a bounding box. When you release the mouse button, the Scope displays the data in that area. You can also click a point in the area you want to zoom in on.

If the scope has multiple  $y$ -axes, and you zoom in on one set of  $x$ - $y$  axes, the  $x$ -limits on all sets of  $x$ - $y$  axes are changed so that they match, because all  $x$ - $y$  axes must share the same time base ( $x$ -axis).

This figure shows a region of the displayed data enclosed within a bounding box.

# Scope, Floating Scope, Signal Viewer Scope

---

Zoom in both directions

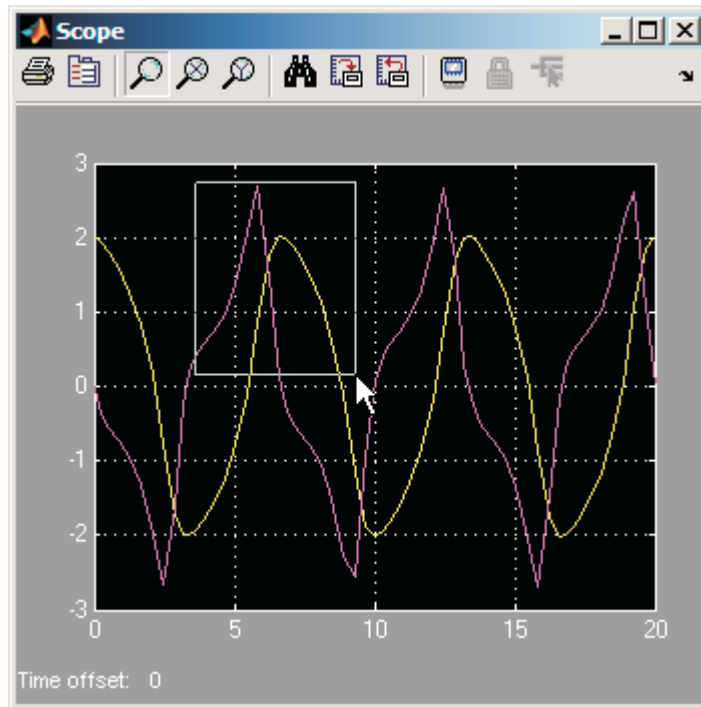

This figure shows the zoomed region, which appears after you release the mouse button.



# Scope, Floating Scope, Signal Viewer Scope

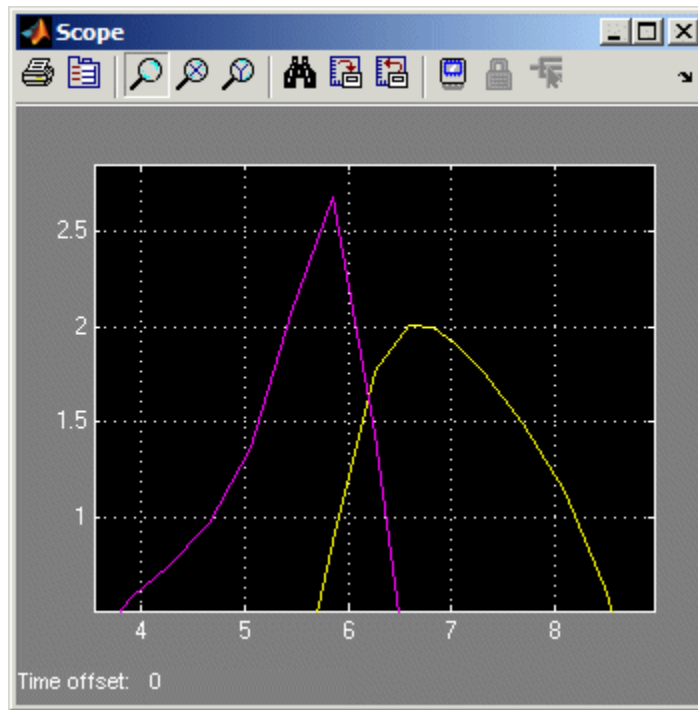

To zoom in on data in just the  $x$  direction, click the middle **Zoom** toolbar button. Define the zoom region by positioning the pointer at one end of the region, pressing and holding down the mouse button, then moving the pointer to the other end of the region. This figure shows the Scope after you define the zoom region, but before you release the mouse button.

# Scope, Floating Scope, Signal Viewer Scope

---

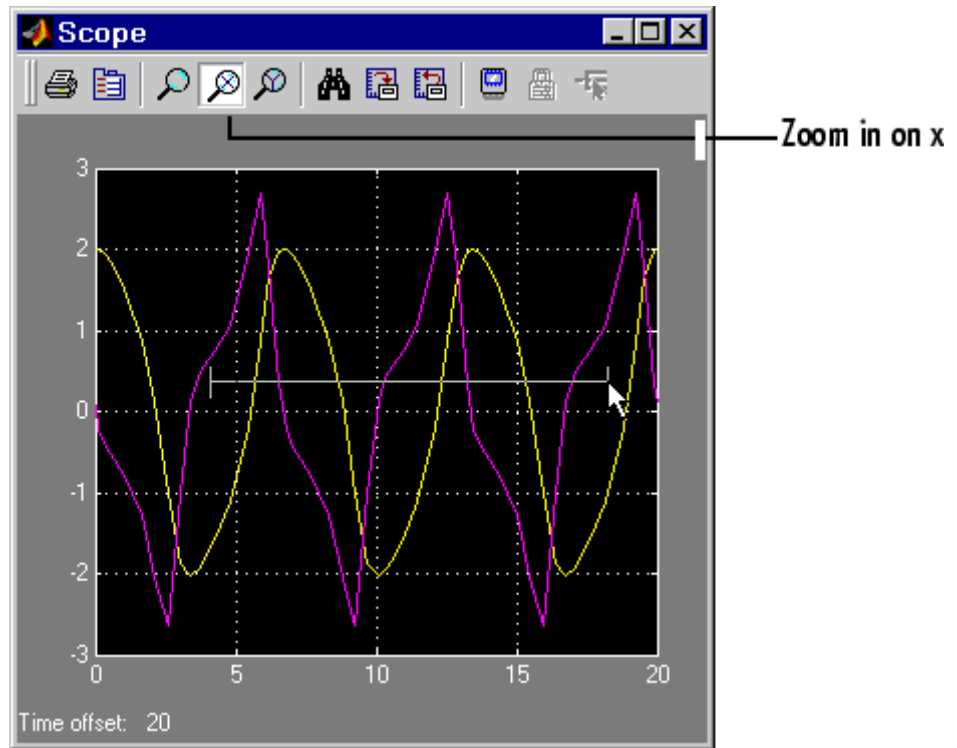

When you release the mouse button, the Scope displays the magnified region. You can also click a point in the area you want to zoom in on.

Zooming in the  $y$  direction works the same way except that you click the rightmost **Zoom** toolbar button before defining the zoom region. Again, you can also click a point in the area you want to zoom in on.

---

**Note** Simulink does not buffer the data that it displays on a floating scope. It therefore cannot zoom the contents of a floating scope. To indicate this, Simulink disables (grays) the **Zoom** button on the toolbar of a floating scope.

---

## Saving the Axes Settings

The **Save axes settings** toolbar button enables you to store the current  $x$ - and  $y$ -axis settings so you can apply them to the next simulation. If you select the **Save axes settings** button on the toolbar of the Scope block's display



the block specifies its current  $y$ -limits as the values of the **Y-min** and **Y-max** parameters (see “Y-Axis Limits” on page 2-590). Similarly, the block specifies its current  $x$ -axis limits as the value of the **Time range** parameter (see “General Parameters Pane” on page 2-599).

## Scope Parameters

The **Scope Parameters** dialog box lets you change axis limits, set the number of axes, time range, tick labels, sampling parameters, and saving options. To display the dialog, select the **Parameters** button on the toolbar of the Scope block's display



or by double-clicking on the Scope viewer's display. The appearance of the dialog box depends on whether the scope is a Scope block or a Scope viewer created by the Signal and Scope Manager. If the scope is a Scope block, this dialog appears.

# Scope, Floating Scope, Signal Viewer Scope

---

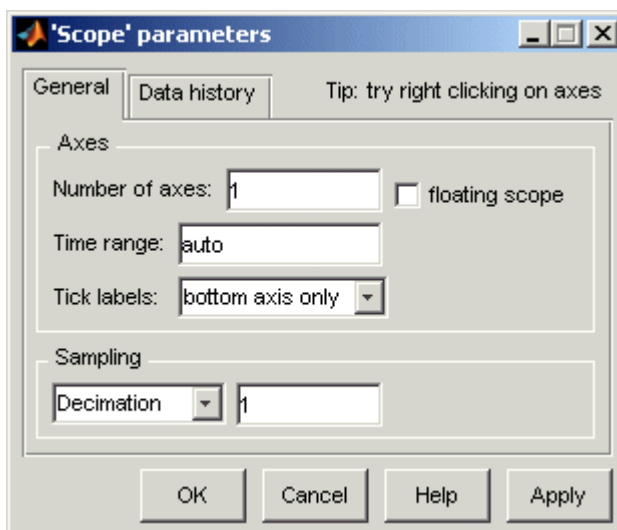

The dialog box has two panes: **General** and **Data history**. See the next topic for information on the **General** parameters pane. See “Data History Parameters Pane” on page 2-605 for information on the **Data history** parameters pane.

If the scope is a Scope viewer, this dialog box appears.

# Scope, Floating Scope, Signal Viewer Scope

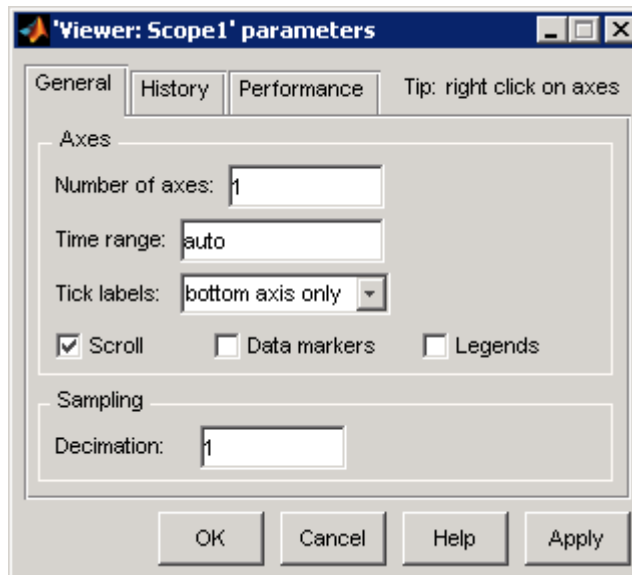

The dialog box has three panes: **General**, **History**, and **Performance**. See the next topic for information on the General parameters pane. See “History Pane” on page 2-607 for information on the **History** parameters pane. See “Performance Parameters Pane” on page 2-606 for information on the **Performance** parameters pane.

## General Parameters Pane

You can set the axis parameters, time range, and tick labels in the **General** pane.

### Number of axes

Set the number of  $y$ -axes in this data field. With the exception of the floating scope, there is no limit to the number of axes the Scope block can contain. All axes share the same time base ( $x$ -axis), but have independent  $y$ -axes. Note that the number of axes is equal to the number of input ports.

# Scope, Floating Scope, Signal Viewer Scope

---

## Time range

Change the  $x$ -axis limits by entering a number or auto in the **Time range** field. Entering a number of seconds causes each screen to display the amount of data that corresponds to that number of seconds. Enter auto to set the  $x$ -axis to the duration of the simulation. Do not enter variable names in these fields.

## Tick labels

Specifies whether to label axes ticks. The options are:

all	Label ticks on the outside of all axes
inside	Place tick labels inside all axes (available only on scope viewers)
bottom-axis only	Place tick labels outside the bottom (or only) axes
none	Do not label ticks (available only on Scope blocks)

---

**Note** The next three options appear only for the dialog box for a Scope viewer.

---

## Scroll

When this option is selected, the scope continuously scrolls the displayed signals to the left so as to keep as much of them in view as will fit on the screen at any one time. When this option is not selected, the scope draws a screenful of data from left to right until the screen is full, erases the screen and draws the next screenful of data, and so on, until the end of simulation time. Note that the effects of this option are discernible only when drawing is slow, for example, when the model is very large or has a very small step size.

## Data Markers

Displays a marker at each data point on the scope viewer screen.

# Scope, Floating Scope, Signal Viewer Scope

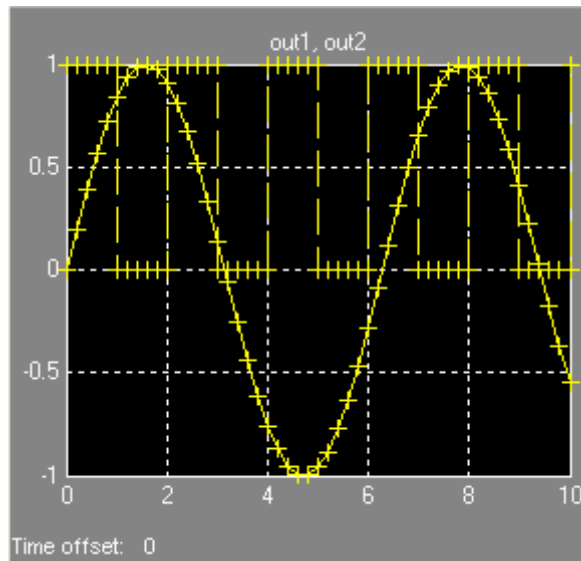

## Legends

Displays a legend on the scope that indicates the line style used to display each signal.

# Scope, Floating Scope, Signal Viewer Scope

---

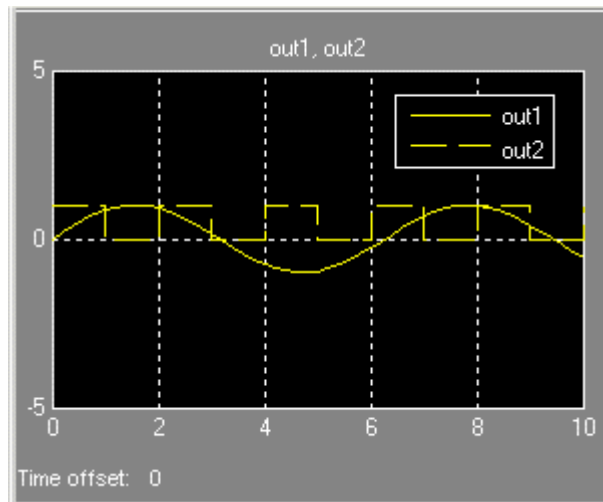

## Floating scope

This option appears only on the **General** parameters pane for the Scope block.

Selecting this option turns a Scope block into a floating scope. A floating scope is a Scope block that can display the signals carried on one or more lines. You can create a Floating Scope block in a model either by copying a Scope block from the Simulink Sinks library into a model and selecting this option or, more simply, by copying the Floating Scope block from the Sinks library into the model window. The Floating Scope block has the **Floating scope** parameter selected by default.

To use a floating scope during a simulation, first open the scope. To display the signals carried on a line, select the line. Hold down the **Shift** key while clicking another line to select multiple lines. It might be necessary to click the **Autoscale data** button on the floating scope's toolbar to find the signal and adjust the axes to the signal values. Or you can use the floating scope's Signal Selector (see "The Signal Selector" in the online Simulink documentation)



# Scope, Floating Scope, Signal Viewer Scope

to select signals for display. To display a floating scope's Signal Selector, first start the simulation of your model with the floating scope open. Then right-click your mouse in the floating scope and select **Signal Selection** from the pop-up menu that appears.

You can have more than one floating scope in a model, but only one set of axes in one scope can be active at a given time. Active floating scopes show the active axes by making them blue. Selecting or deselecting lines affects the active floating scope only. Other floating scopes continue to display the signals that you selected when they were active. In other words, inactive floating scopes are locked, in that their signal displays cannot change.

To specify display of a signal on one of the axes of a multi-axis floating scope, click the axis. Simulink draws a blue border around the axis.

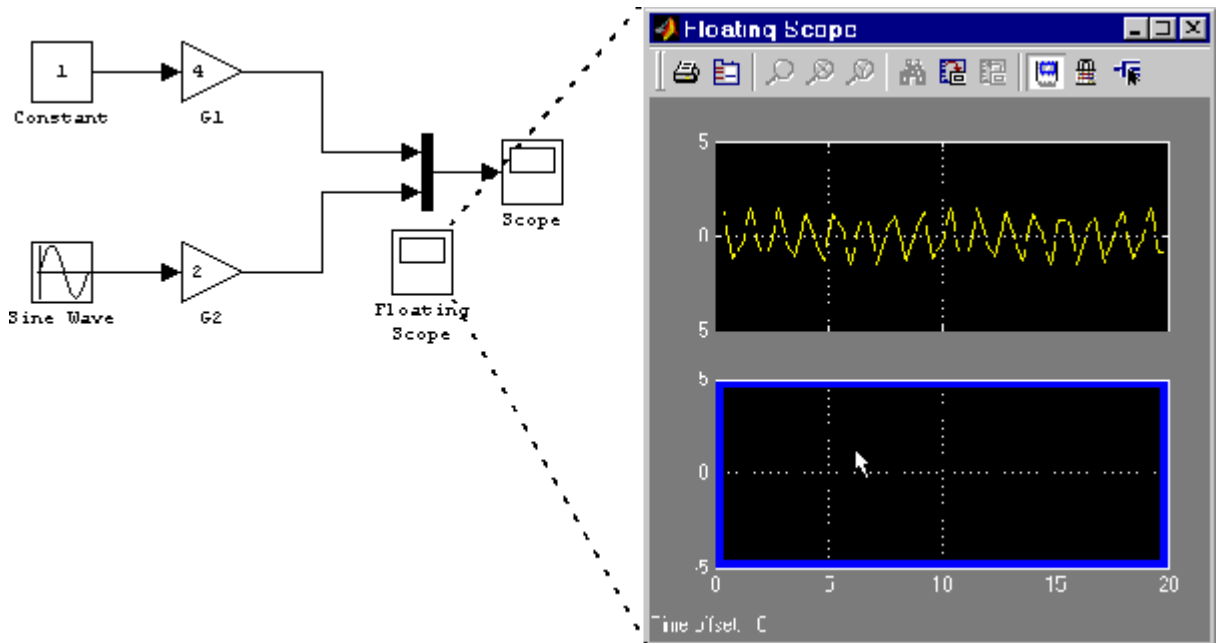

# Scope, Floating Scope, Signal Viewer Scope

Then click the signal you want to display in the block diagram or the Signal Selector. When you run the model, the selected signal appears in the selected axis.

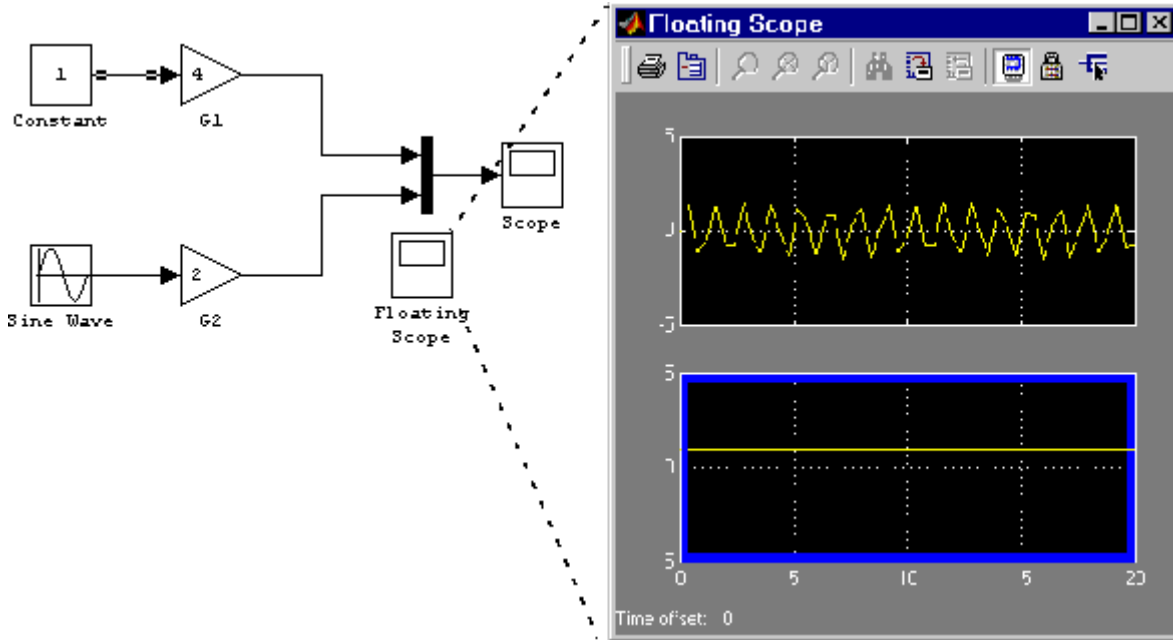

If you plan to use a floating scope during a simulation, you should disable signal storage reuse. See "Signal storage reuse" in "Optimization Pane" for more information.

## Sampling

To specify a decimation factor, enter a number in the data field to the right of the **Decimation** choice. To display data at a sampling interval, select the **Sample time** choice and enter a number in the data field.

# Scope, Floating Scope, Signal Viewer Scope

## Data History Parameters Pane

The **Data History** parameters pane appears only on the **Parameters** dialog box for the Scope block. The pane appears as follows.

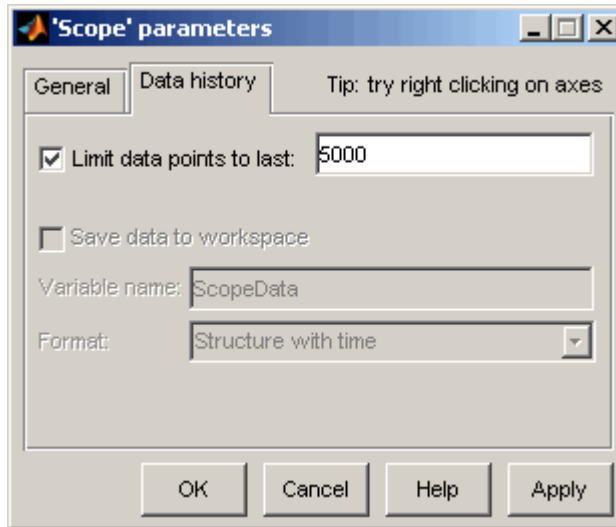

This pane lets you control the amount of data that the Scope stores and displays. You can also choose to save data to the workspace in this pane. You apply the current parameters and options by clicking the **Apply** or **OK** button. The values that appear in these fields are the values that are used in the next simulation.

### Limit data points to last

You can limit the number of data points saved to the workspace by selecting the **Limit data points to last** check box and entering a value in its data field. The Scope relies on its data history for zooming and autoscaling operations. If the number of data points is limited to 1,000 and the simulation generates 2,000 data points, only the last 1,000 are available for regenerating the display.

# Scope, Floating Scope, Signal Viewer Scope

---

## **Save data to workspace**

You can automatically save the data collected by the Scope at the end of the simulation by selecting the **Save data to workspace** check box. If you select this option, the **Variable name** and **Format** fields become active.

## **Variable name**

Enter a variable name in the **Variable name** field. The specified name must be unique among all data logging variables being used in the model. Other data logging variables are defined on other Scope blocks, To Workspace blocks, and simulation return variables such as time, states, and outputs. Being able to save Scope data to the workspace means that it is not necessary to send the same data stream to both a Scope block and a To Workspace block.

## **Format**

Data can be saved in one of three formats: Array, Structure, or Structure with time. Use Array only for a Scope with one set of axes. For Scopes with more than one set of axes, use Structure if you do not want to store time data and use Structure with time if you want to store time data.

## **Performance Parameters Pane**

The **Performance** parameters pane appears only on the **Parameters** dialog box for the Scope viewer. The pane appears as follows.

# Scope, Floating Scope, Signal Viewer Scope

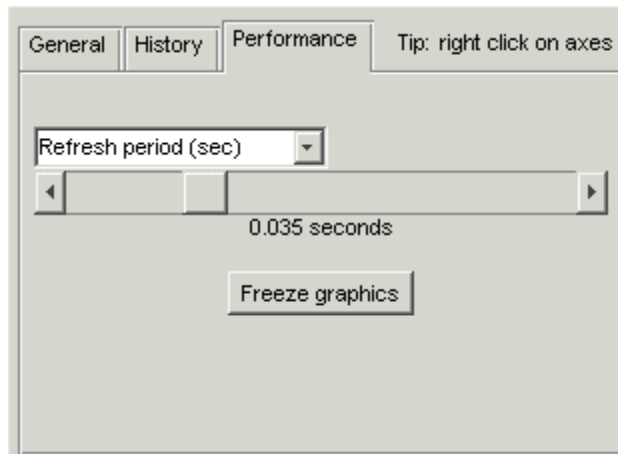

This pane lets you control how frequently Simulink refreshes the Scope viewer. Reducing the refresh rate can speed up the simulation in some cases. The pane contains the following controls.

## Refresh Period

This list control lets you select the units in which the refresh period is expressed. Options are either seconds or frames where a frame is the width of the scope's screen in seconds, i.e., it equals the value of the scope's **Time range** parameter.

## Refresh Slider

Drag the slider button to the right to increase the refresh period and hence decrease the refresh rate.

## Freeze Button

Click the button to freeze (stop refreshing) or unfreeze the Scope viewer.

## History Pane

The **History** parameters pane appears only on the **Parameters** dialog box for the Scope viewer.

# Scope, Floating Scope, Signal Viewer Scope

---

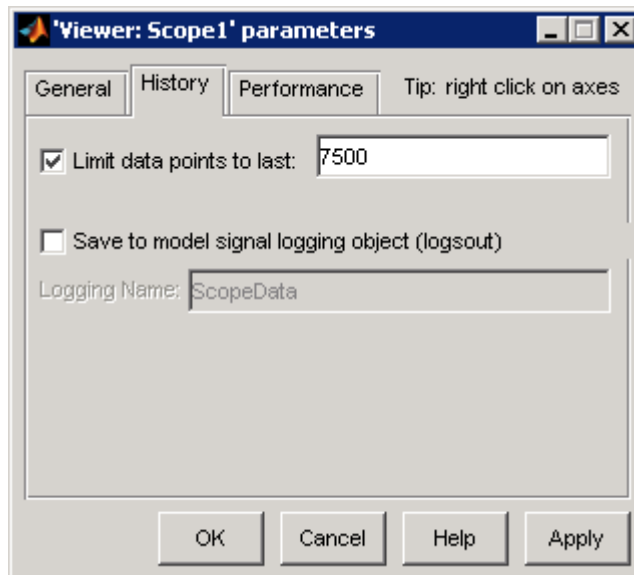

This pane lets you control the amount of data that the Scope viewer stores and displays. You can also choose to save data to the workspace in this pane. You apply the current parameters and options by clicking the **Apply** or **OK** button. The values that appear in these fields are the values that are used in the next simulation.

## **Limit data points to last**

You can limit the number of data points saved to the workspace by selecting the **Limit data points to last** check box and entering a value in its data field. The Scope relies on its data history for zooming and autoscaling operations. If the number of data points is limited to 1,000 and the simulation generates 2,000 data points, only the last 1,000 are available for regenerating the display.

## **Save to model signal logging object**

Check this option to save data displayed on the scope viewer at the end of the simulation. Simulink saves the data in the `Simulink.ModelDataLogs` object used to log data for the model (see “Logging Signals” for more information). For this option to

# Scope, Floating Scope, Signal Viewer Scope

take effect, you must also enable signal logging for the model as a whole, i.e., you must check the **Signal logging** option on the **Data Import/Export** pane of the model's **Configuration Parameters** dialog box.

## Logging Name

Specifies the name under which to store the viewer's data in the model's `Simulink.ModelDataLogs` object. The name must be different from the log names specified by other signal viewers or for other signals, subsystems, or model references logged in the model's `Simulink.ModelDataLogs` object.

## Printing the Contents of a Scope Window

To print the contents of a Scope window, open the **Print** dialog box by clicking the **Print** icon, the leftmost icon on the Scope toolbar.



## Creating an Editable Figure from a Scope Block

To create a figure that looks identical to the Scope window but can be annotated using the Plot Editing Tools, use the `simplot` command. Only Scope blocks that save data to the MATLAB workspace from the **Data history** pane are compatible with this command. For example, on the **Data history** pane for the Scope block in `vdp.mdl`, check the **Save data to workspace** option and select **Structure with time** from the **Format** list. After running the simulation, a figure can be created with the command

```
simplot(ScopeData)
```

## Data Type Support

The Scope block accepts real signals of any data type supported by Simulink, including fixed-point data types. The Scope block accepts homogeneous vectors.

For a discussion on the data types supported by Simulink, see “Data Types Supported by Simulink” in the Simulink documentation.

## Scope, Floating Scope, Signal Viewer Scope

---

<b>Characteristics</b>	Sample Time	Inherited from driving block or can be set
	States	0
	Multidimensionalized	Yes



**Purpose** Select input elements from vector, matrix, or multidimensional signal

**Library** Signal Routing

## Description

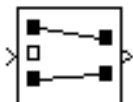

The Selector block generates as output selected or reordered elements of an input vector, matrix, or multidimensional signal.

A Selector block accepts vector, matrix, or multidimensional signals as input. The parameter dialog box and the block's appearance change to reflect the number of dimensions of the input.

Based on the value you enter for the **Number of input dimensions** parameter, a table of indexing settings is displayed. Each row of the table corresponds to one of the input dimensions in **Number of input dimensions**. For each dimension, you define the elements of the signal to work with. Specify a vector signal as a 1-D signal and a matrix signal as a 2-D signal. When you configure the Selector block for multidimensional signal operations, the block icon changes.

For example, assume a 5-D signal with a one-based index mode. The table of the Selector block dialog changes to include one row for each dimension. If you define each dimension with the following entries:

- **1**  
**Index Option**, select Select all
- **2**  
**Index Option**, select Starting index (dialog)  
**Index**, enter 2  
**Output Size**, enter 5
- **3**  
**Index Option**, select Index vector (dialog)  
**Index**, enter [1 3 5]
- **4**

# Selector

---

**Index Option**, select Starting index (port)

**Output Size**, enter 8

- 5

**Index Option**, select Index vector (port)

The output will be  $Y=U(1:end,2:6,[1\ 3\ 5],Idx4:Idx4+7,Idx5)$ , where  $Idx4$  and  $Idx5$  are the index ports for dimensions 4 and 5.

## Data Type Support

The data port of the Selector block accepts signals of any signal type and any data type supported by Simulink, including fixed-point data types. The data port accepts mixed-type signals. The index port accepts only built-in data types, except boolean data types. The elements of the output have the same type as the corresponding selected input elements.

For a discussion on the data types supported by Simulink, see “Data Types Supported by Simulink” in the Simulink documentation.

## Parameters and Dialog Box

The parameter dialog box appears as follows when you set **Index Option** to Starting index (port).

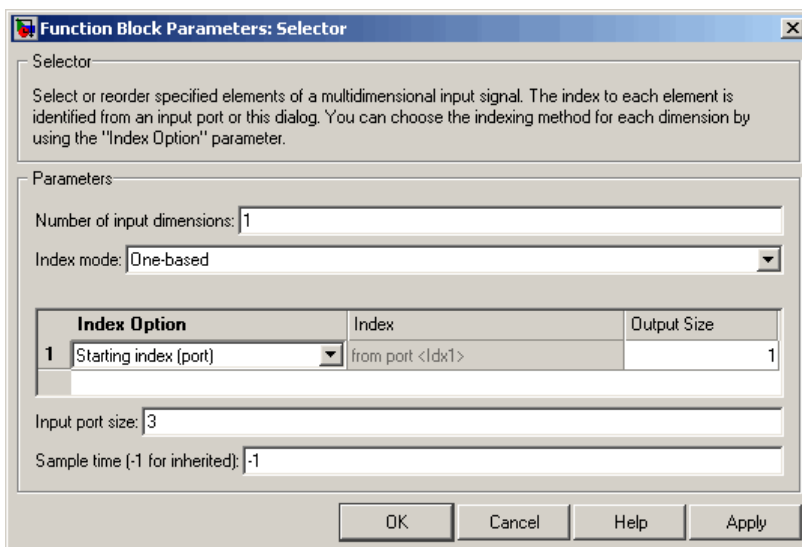

The dialog box titled "Function Block Parameters: Selector" contains the following fields and controls:

- Selector**: A text area with the instruction: "Select or reorder specified elements of a multidimensional input signal. The index to each element is identified from an input port or this dialog. You can choose the indexing method for each dimension by using the 'Index Option' parameter."
- Parameters**:
  - Number of input dimensions: 1
  - Index mode: One-based
  - Index Option** table:
- Input port size: 3
- Sample time (-1 for inherited): -1
- Buttons: OK, Cancel, Help, Apply

	Index Option	Index	Output Size
1	Starting index (port)	from port <ldx1>	1

### Number of input dimensions

Enter the number of dimensions of the input signal.

### Index mode

Specifies the indexing mode: One-based or Zero-based. If One-based is selected, an index of 1 specifies the first element of the input vector, 2, the second element, and so on. If Zero-based is selected, an index of 0 specifies the first element of the input vector, 1, the second element, and so on.

### Index Option

Define, by dimension, how the elements of the signal are to be indexed. From the list, choose:

- Select all

This is the default. No further configuration is required. All elements are selected.

# Selector

---

- **Index vector (dialog)**  
Enables the **Index** column. Enter the vector of indices of the elements.
- **Index vector (port)**  
No further configuration is required.
- **Starting index (dialog)**  
Enables the **Index** and **Output Size** columns. Enter the starting index of the range of elements to be selected in the **Index** column and the number of elements to be selected in the **Output Size** column.
- **Starting index (port)**  
Enables the **Output Size** column. Enter the number of elements to be selected in the **Output Size** column.

The **Index** and **Output Size** columns are displayed as relevant.

## **Index**

If the **Index Option** is **Index vector (dialog)**, enter the index of each element you are interested in.

If the **Index Option** is **Starting index vector (dialog)**, enter the starting index of the range of elements to be selected.

## **Output Size**

Enter the width (number of elements from the starting point) of the block output signal.

## **Input port size**

Specify the width of the block input signal (-1 for inherited) — 1-D signals only.

## **Sample time (-1 for inherited)**

Specify the time interval between samples. To inherit the sample time, set this parameter to -1. See “Specifying Sample Time” in the online documentation for more information.

---

**Note** For 1-D signals, the **Sample time** parameter is applicable only with the **Index Option** set to Starting index (port) or Index vector (port). For all other **Input Option** settings, the Selector block becomes a virtual block and the **Sample time** parameter does not appear.

---

## Characteristics

Sample Time	Specified in the <b>Sample time</b> parameter.
Dimensionalized	Yes
Multidimensionalized	Yes
Zero crossing	No

# S-Function

---

**Purpose** Include S-function in model

**Library** User-Defined Functions

**Description**

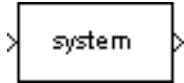

The S-Function block provides access to S-functions from a block diagram. The S-function named as the **S-function name** parameter can be a Level-1 M-file or a Level-1 or Level-2 C MEX-file S-function (see “Overview of S-Functions” in *Writing S-Functions* for information on how to create S-functions).

---

**Note** Use the M-File S-Function block to include a Level-2 M-file S-function in a block diagram.

---

The S-Function block allows additional parameters to be passed directly to the named S-function. The function parameters can be specified as MATLAB expressions or as variables separated by commas. For example,

```
A, B, C, D, [eye(2,2);zeros(2,2)]
```

Note that although individual parameters can be enclosed in brackets, the list of parameters must not be enclosed in brackets.

The S-Function block displays the name of the specified S-function and the number of input and output ports specified by the S-function. Signals connected to the inputs must have the dimensions specified by the S-function for the inputs.

**Data Type Support**

Depends on the implementation of the S-Function block.

## Parameters and Dialog Box

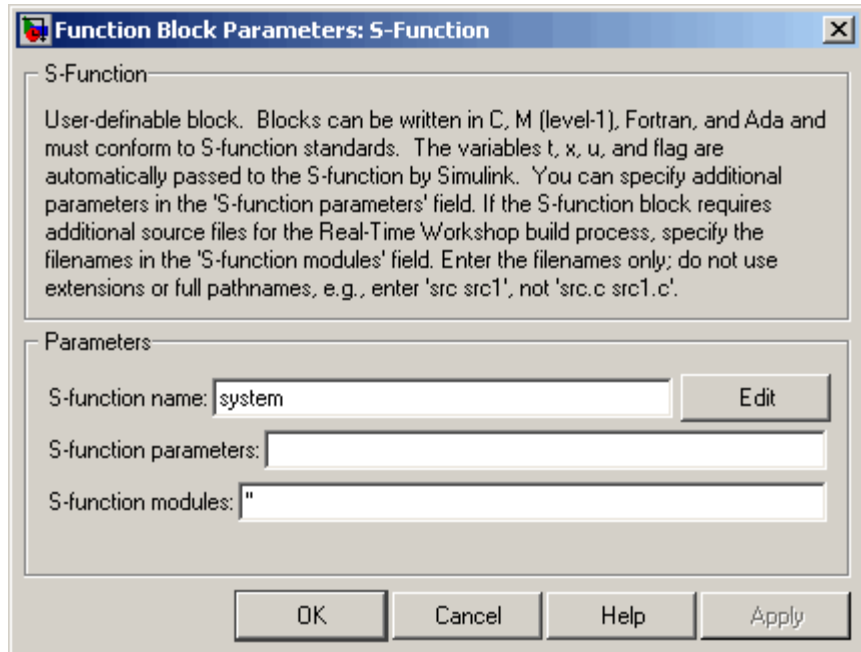

### **S-function name**

The S-function name.

### **S-function parameters**

Additional S-function parameters. See the preceding block description for information on how to specify the parameters.

### **S-function modules**

This parameter applies only if this block represents a C MEX-file S-function and you intend to use the Real-Time Workshop to generate code from the model containing the block. See “Specifying Additional Source Files for an S-Function” in the Real-Time Workshop online documentation for information on using this parameter.

# S-Function

---

<b>Characteristics</b>	Direct Feedthrough	Depends on contents of S-function
	Sample Time	Depends on contents of S-function
	Scalar Expansion	Depends on contents of S-function
	Dimensionalized	Depends on contents of S-function
	Multidimensionalized	Yes
	Zero Crossing	No



**Purpose** Create S-function from C code that you provide

**Library** User-Defined Functions

## Description

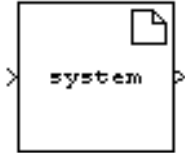

The S-Function Builder block creates a C MEX-file S-function from specifications and C source code that you provide. See “Building S-Functions Automatically” for detailed instructions on using the S-Function Builder block to generate an S-function.

Instances of the S-Function Builder block also serve as wrappers for generated S-functions in Simulink models. When simulating a model containing instances of an S-Function Builder block, Simulink invokes the generated S-function associated with each instance to compute the instance’s output at each time step.

---

**Note** The S-Function Builder block does not support masking. However, you can mask a Subsystem block that contains an S-Function Builder block. See “Creating Block Masks” in the Simulink documentation for more information.

---

## Data Type Support

The S-Function Builder can accept and output complex, 1-D or 2-D signals of any data type supported by Simulink.

For a discussion on the data types supported by Simulink, see “Data Types Supported by Simulink” in the Simulink documentation.

## Parameters and Dialog Box

See “S-Function Builder Dialog Box” in the online documentation for information on using the S-Function Builder block’s parameter dialog box.

# Shift Arithmetic

---

**Purpose** Shift bits and/or binary point of signal

**Library** Logic and Bit Operations

**Description** The Shift Arithmetic block can be used to shift the bits or the binary point of a signal, or both.

For example, the effects of binary point shifts two places to the right and two places to the left on an input of data type `sfixed(8)` are shown below.

Shift Operation	Binary Value	Decimal Value
No shift (original number)	11001.011	-6.625
Binary point shift right by two places	1100101.1	-26.5
Binary point shift left by two places	110.01011	-1.65625

This block performs arithmetic bit shifts on signed numbers. Therefore, the most significant bit is recycled for each bit shift. The effects of bit shifts two places to the right and two places to the left on an input of data type `sfixed(8)` follow.

Shift Operation	Binary Value	Decimal Value
No shift (original number)	11001.011	-6.625
Bit shift right by two places	11110.010	-1.75
Bit shift left by two places	00101.100	5.5

**Data Type Support** The Shift Arithmetic block accepts signals of any data type supported by Simulink, including fixed-point data types, except boolean type.

## Parameters and Dialog Box

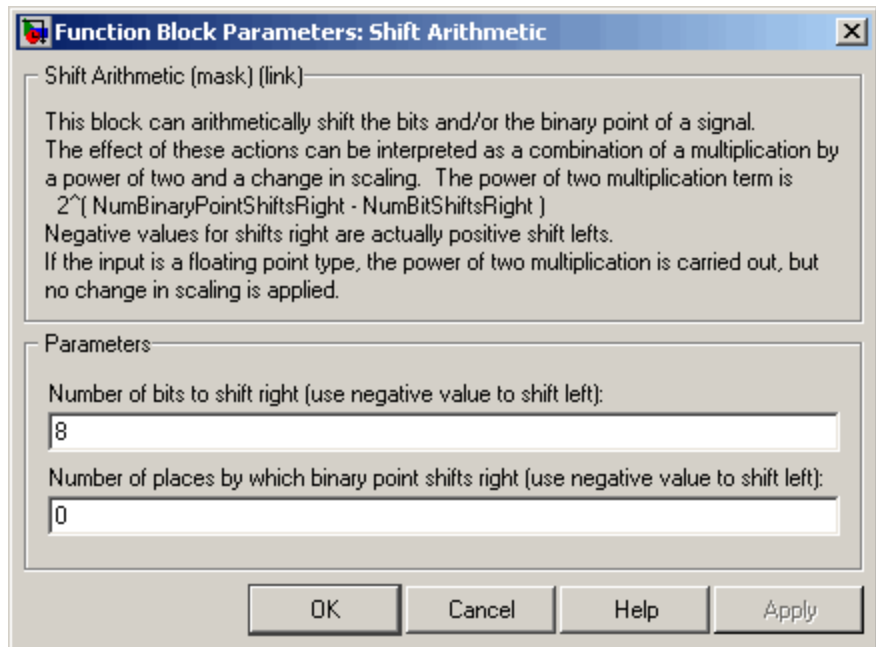

### Number of bits to shift right

The number of places the bits of the input signal is shifted. A positive value indicates a shift right, while a negative value indicates a shift left.

### Number of places by which binary point shifts right

The number of places the binary point of the input signal is shifted. A positive value indicates a shift right, while a negative value indicates a shift left.

## Characteristics

Direct Feedthrough	Yes
Sample Time	Inherited
Scalar Expansion	Yes

# Sign

**Purpose** Indicate sign of input

**Library** Math Operations

**Description** The Sign block indicates the sign of the input:

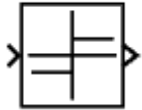

- The output is 1 when the input is greater than zero.
- The output is 0 when the input is equal to zero.
- The output is -1 when the input is less than zero.

## Data Type Support

The Sign block accepts real signals of any data type supported by Simulink, including fixed-point data types. The output is a signed data type with the same number of bits as the input, and with nominal scaling (a slope of one and a bias of zero).

For a discussion on the data types supported by Simulink, see “Data Types Supported by Simulink” in the Simulink documentation.

## Parameters and Dialog Box

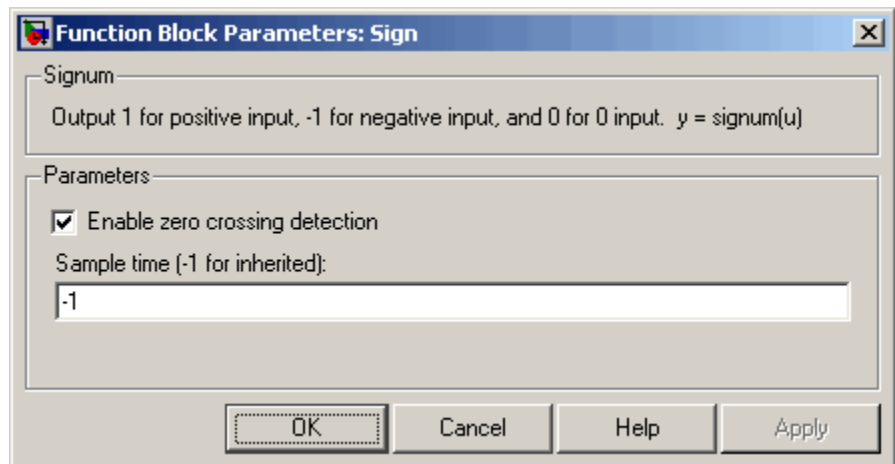

**Enable zero crossing detection**

Select to enable zero crossing detection. For more information, see “Zero-Crossing Detection” in the “How Simulink Works” chapter of the Using Simulink documentation.

**Sample time (-1 for inherited)**

Specify the time interval between samples. To inherit the sample time, set this parameter to -1. See “Specifying Sample Time” in the online documentation for more information.

**Characteristics**

Direct Feedthrough	Yes
Sample Time	Specified in the <b>Sample time</b> parameter
Scalar Expansion	N/A
Dimensionalized	Yes
Zero Crossing	Yes, if enabled.

# Signal Builder

---

**Purpose** Create and generate interchangeable groups of signals whose waveforms are piecewise linear

**Library** Sources

**Description** The Signal Builder block allows you to create interchangeable groups of piecewise linear signal sources and use them in a model. See “Working with Signal Groups” in the “Working with Signals” chapter of the Using Simulink documentation.



---

**Note** Use the `signalbuilder` function to create and access Signal Builder blocks programmatically.

---

**Data Type Support** The Signal Builder block outputs a scalar or array of real signals of type double.

**Parameters and Dialog Box** The Signal Builder block has the same dialog box as that of a Subsystem block. To display the dialog box, select **Subsystem Parameters** from the block’s context menu.

Characteristics	
Sample Time	Continuous
Scalar Expansion	Yes, of parameters
Dimensionalized	Yes
Zero Crossing	Yes

<b>Purpose</b>	Convert signal to new type without altering signal values
<b>Library</b>	Signal Attributes
<b>Description</b>	The Signal Conversion block converts a signal from one type to another. The block's <b>Output</b> parameter lets you select the type of conversion to be performed.
<b>Data Type Support</b>	The Signal Conversion block accepts virtual or nonvirtual signals of any data type.

## Parameters and Dialog Box

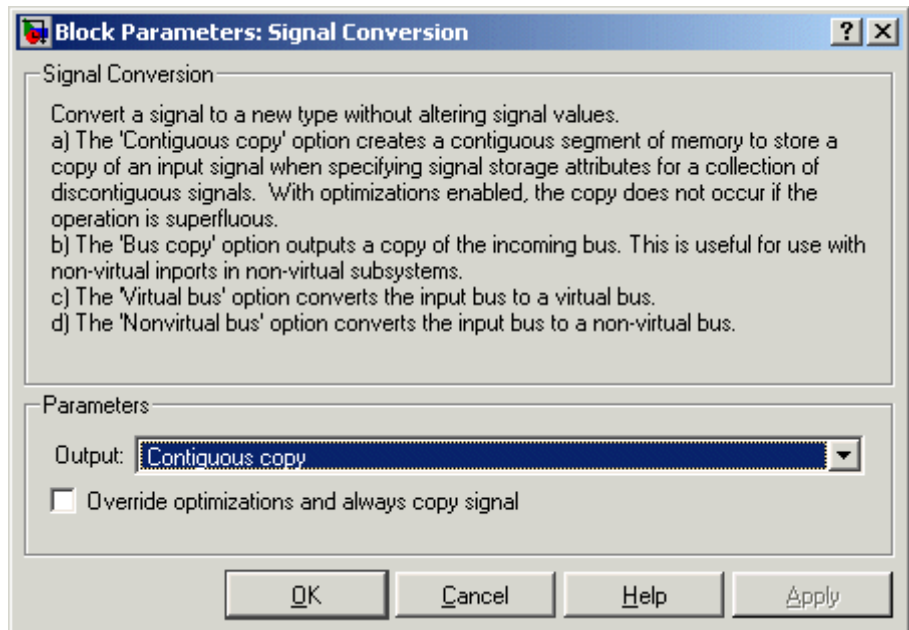

## Output

Specifies the type of conversion to be performed. The options are:

- Contiguous copy

# Signal Conversion

---

Converts a muxed signal whose elements occupy discontinuous areas of memory to a vector signal whose elements occupy contiguous areas of memory. The block does this by allocating a contiguous area of memory for the elements of the muxed signal and copying the values from the discontinuous areas (represented by the block's input) to the contiguous areas (represented by the block's output) at each time step. You can also use this setting to connect a block with a constant sample time to an output port of an enabled subsystem. (See *Using Blocks with Constant Sample Times in Enabled Subsystems*) For an example involving Real-Time Workshop, see “Reusable Code and Referenced Models”.

- Bus copy

Outputs a copy of the bus connected to the block's input. This setting is useful when passing a bus signal whose components have different data types to a nonvirtual Inport block in an Atomic Subsystem. See “Using Composite Signals” in *Using Simulink* for more information.

- Virtual bus

Converts a nonvirtual bus to a virtual bus. In general, virtual buses can save memory where nonvirtual buses are not required.

- Nonvirtual bus

Converts a virtual bus to a nonvirtual bus as in the following example. This setting is useful when passing a virtual bus signal to a modeling construct that requires a non-virtual bus, such as a Model block.

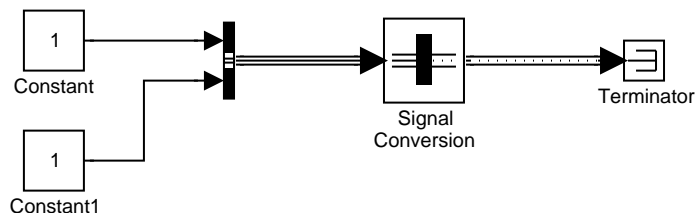



---

**Note** The virtual bus to be converted to a nonvirtual bus must be defined by a bus object, i.e., an instance of `Simulink.Bus` class. See the Bus Creator block for more information.

---

### **Override optimizations and always copy signal**

This option is enabled only for Contiguous copy conversion. Unless you select this option, Simulink eliminates the block from the compiled model as an optimization, if the elements of the input signal occupy contiguous areas of memory.

### **Characteristics**

Sample Time	Inherited
Scalar Expansion	n/a
Dimensionalized	n/a
Multidimensionalized	Yes
Zero Crossing	No

# Signal Generator

---

**Purpose**                      Generate various waveforms

**Library**                      Sources

**Description**                The Signal Generator block can produce one of four different waveforms: sine wave, square wave, sawtooth wave, and random wave. The signal parameters can be expressed in Hertz (the default) or radians per second. This figure shows each signal displayed on a Scope using default parameter values.



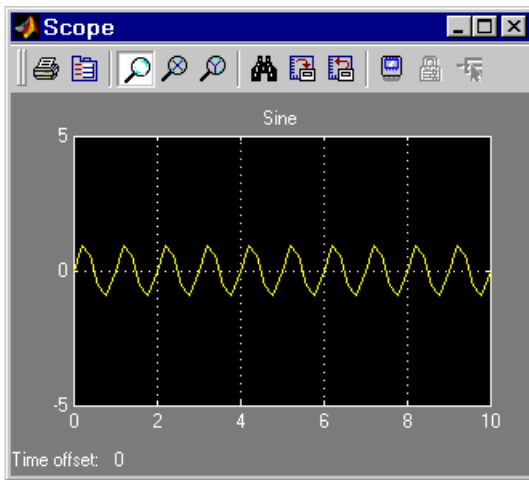

Sine Wave

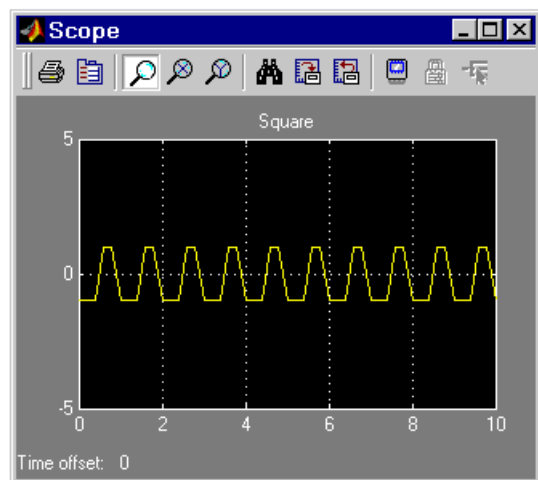

Square Wave

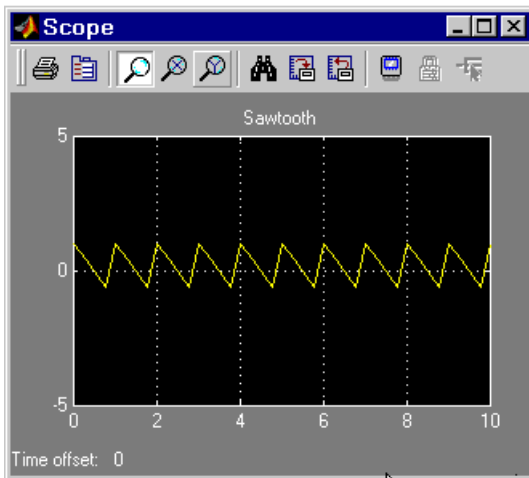

Sawtooth Wave

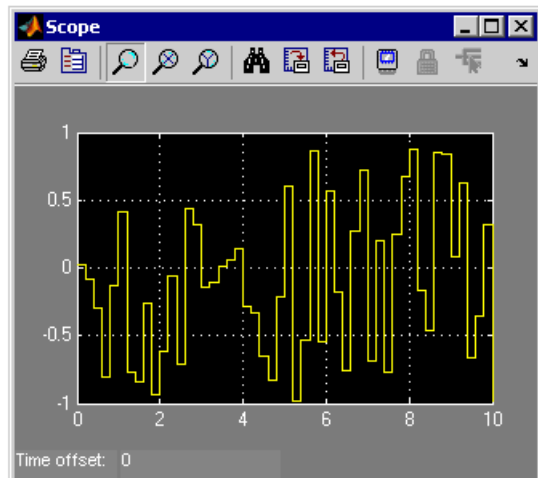

Random Wave

A negative **Amplitude** parameter value causes a 180-degree phase shift. You can generate a phase-shifted wave at other than 180 degrees

# Signal Generator

---

in a variety of ways, including connecting a Clock block signal to a MATLAB Fcn block and writing the equation for the particular wave.

You can vary the output settings of the Signal Generator block while a simulation is in progress. This is useful to determine quickly the response of a system to different types of inputs.

The block's **Amplitude** and **Frequency** parameters determine the amplitude and frequency of the output signal. The parameters must be of the same dimensions after scalar expansion. If the **Interpret vector parameters as 1-D** option is off, the block outputs a signal of the same dimensions as the **Amplitude** and **Frequency** parameters (after scalar expansion). If the **Interpret vector parameters as 1-D** option is on, the block outputs a vector (1-D) signal if the **Amplitude** and **Frequency** parameters are row or column vectors, i.e. single row or column 2-D arrays. Otherwise, the block outputs a signal of the same dimensions as the parameters.

## Data Type Support

The Signal Generator block outputs a scalar or array of real signals of type double.

## Parameters and Dialog Box

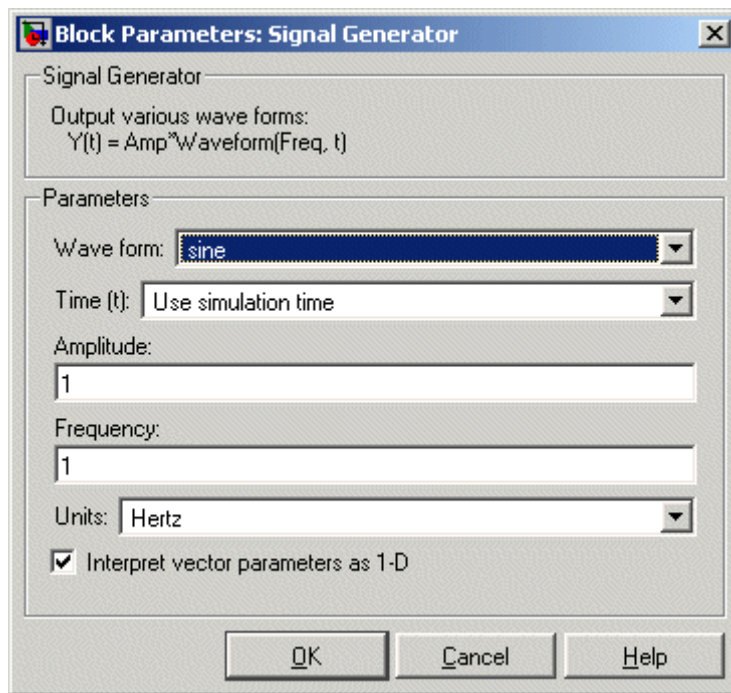

Opening this dialog box causes a running simulation to pause. See “Changing Source Block Parameters During Simulation” in the online Simulink documentation for details.

### Wave form

The wave form: a sine wave, square wave, sawtooth wave, or random wave. The default is a sine wave. This parameter cannot be changed while a simulation is running.

### Time

Specifies whether to use simulation time as the source of values for the waveform’s time variable or an external signal. If you specify an external time source, the block displays an input port for the time source.

# Signal Generator

---

## **Amplitude**

The signal amplitude. The default is 1.

## **Frequency**

The signal frequency. The default is 1.

## **Units**

The signal units: Hertz or radians/sec. The default is Hertz.

## **Interpret vector parameters as 1-D**

If selected, column or row matrix values for the **Amplitude** and **Frequency** parameters result in a vector output signal (see “Determining the Output Dimensions of Source Blocks” in the “Working with Signals” chapter of the Using Simulink documentation). This option is not available when an external signal specifies time. In this case, if the **Amplitude** and **Frequency** parameters are column or row matrix values, the output is a 1-D vector.

## **Characteristics**

Sample Time	Continuous
Scalar Expansion	Yes, of parameters
Dimensionalized	Yes
Zero Crossing	No

**Purpose** Specify desired dimensions, sample time, data type, numeric type, and other attributes of signal

**Library** Signal Attributes

## Description

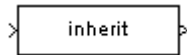

The Signal Specification block allows you to specify the attributes of the signal connected to its input and output ports. If the specified attributes conflict with the attributes specified by the blocks connected to its ports, Simulink displays an error when it compiles the model, for example, at the beginning of a simulation. If no conflict exists, Simulink eliminates the Signal Specification block from the compiled model. In other words, the Signal Specification block is a virtual block. It exists only to specify the attributes of a signal and plays no role in the simulation of the model.

You can use the Signal Specification block to ensure that the actual attributes of a signal meet desired attributes. For example, suppose that you and a colleague are working on different parts of the same model and you use Signal Specification blocks to connect your part of the model with your colleague's. Now, if your colleague changes the attributes of a signal without informing you, the attributes entering the corresponding Signal Specification block do not match and Simulink reports an appropriate error.

The Signal Specification block can also be used to ensure correct propagation of signal attributes throughout a model. The capability of allowing many attributes to be propagated from block to block in Simulink is very powerful. However, because blocks may not specify some or all of the attributes of the signals they accept or output, it is possible to create models that don't have enough information to correctly propagate attributes around the model. For these cases, the Signal Specification block is a good way of providing the information Simulink needs. Using the Signal Specification block also helps speed up model compilation when blocks are missing signal attributes.

# Signal Specification

## Data Type Support

The Signal Specification block accepts real or complex signals of any data type supported by Simulink, including fixed-point data types. The input data type must match the data type specified by the **Data type** parameter.

For a discussion on the data types supported by Simulink, see “Data Types Supported by Simulink” in the Simulink documentation.

## Parameters and Dialog Box

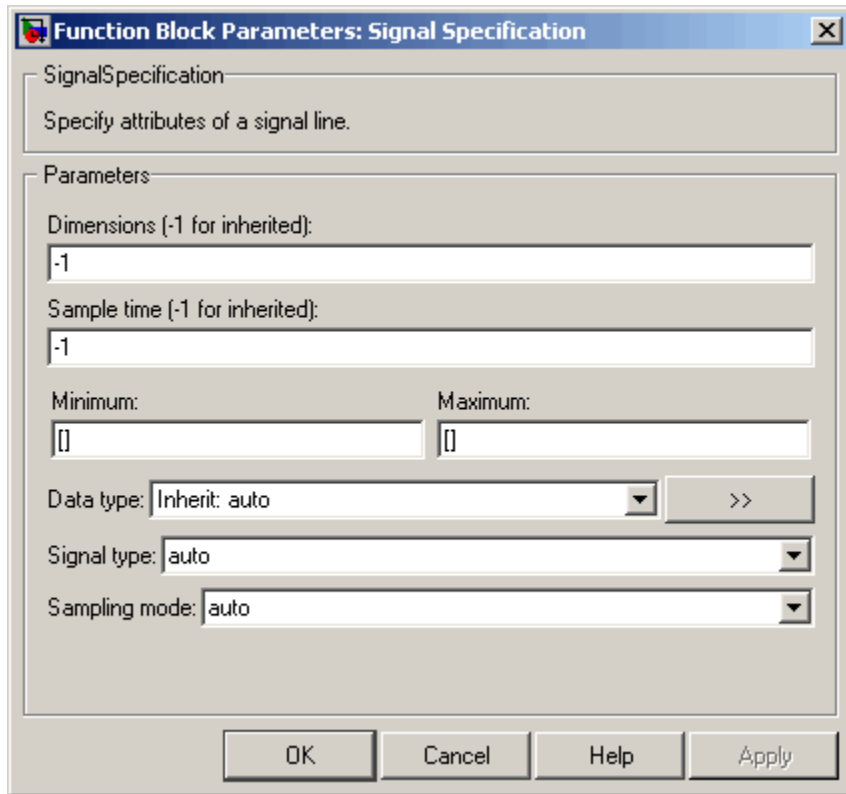

## Dimensions

Specify the dimension's of the block's input and output signals. Valid values are



- -1--Inherited from the block to which it is connected
- n--Vector signal of width n
- [m n]--Matrix signal having m rows and n columns

## Sample Time

Specify the sample time at which the block is updated. Valid values are

- -1--inherited from the block to which it is connected
- period  $\geq 0$
- [period, offset]
- [0, -1]
- [-1, -1]

where period is the sample rate and offset is the offset of the sample period from time zero. See “Specifying Sample Time” in the online documentation for more information.

## Minimum

Specify the minimum value that the block should output. The default value, [], is equivalent to  $-\text{Inf}$ . Simulink uses this value to perform:

- Simulation range checking (see “Checking Signal Ranges”)
- Automatic scaling of fixed-point data types

## Maximum

Specify the maximum value that the block should output. The default value, [], is equivalent to  $\text{Inf}$ . Simulink uses this value to perform:

- Simulation range checking (see “Checking Signal Ranges”)
- Automatic scaling of fixed-point data types

# Signal Specification

---

## Data type

Specify the output data type. You can set it to:

- A rule that inherits a data type, for example, `Inherit: auto`
- The name of a built-in data type, for example, `single`
- The name of a data type object, for example, a `Simulink.NumericType` object
- An expression that evaluates to a data type, for example, `float('single')`

Click the **Show data type assistant** button  to display the **Data Type Assistant**, which helps you set the **Data type** parameter.

See “Specifying Block Output Data Types” in *Using Simulink* for more information.

## Signal type

Specify the numeric type (real or complex) of the input and output signal. To let Simulink determine the numeric type, set this parameter to `auto`.

## Sampling mode

Specify the sampling mode (sample-based or frame-based) of this block. To let Simulink determine the sampling mode, set this parameter to `auto`.

## Characteristics

Direct Feedthrough	Yes
Sample Time	Specified by the block's <b>Sample time</b> parameter.
Scalar Expansion	No
Dimensionalized	Yes

# Signal Specification

---

Multidimensionalized	Yes
Zero Crossing	No

# Sine

---

## Purpose

Implement sine wave in fixed-point using lookup table approach that exploits quarter wave symmetry

## Library

Lookup Tables

## Description

The Sine block is an implementation of the Sine and Cosine block. See [Sine](#) and [Cosine](#) for more information.

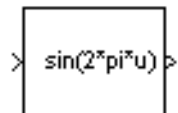

<b>Purpose</b>	Implement sine and/or cosine wave in fixed point using lookup table approach that exploits quarter wave symmetry
<b>Library</b>	Lookup Tables (Sine block or Cosine block)
<b>Description</b>	<p>The Sine and Cosine block implements a sine and/or cosine wave in fixed point using a lookup table method that exploits quarter wave symmetry.</p> <p>The Sine and Cosine block can output the following functions of the input signal, depending upon what you select for the <b>Output formula</b> parameter:</p> <ul style="list-style-type: none"><li>• <math>\sin(2\pi u)</math></li><li>• <math>\cos(2\pi u)</math></li><li>• <math>\exp(i2\pi u)</math></li><li>• <math>\sin(2\pi u)</math> and <math>\cos(2\pi u)</math></li></ul> <p>You define the number of lookup table points in the <b>Number of data points for lookup table</b> parameter. The block implementation is most efficient when you specify the lookup table data points to be <math>(2^n)+1</math>, where <math>n</math> is an integer.</p> <p>Use the <b>Output word length</b> parameter to specify the word length of the fixed-point output data type. The fraction length of the output is the output word length minus 2.</p>
<b>Data Type Support</b>	The Sine and Cosine block accepts signals of any data type supported by Simulink, including fixed-point data types. The output of the block is a fixed-point data type.

# Sine and Cosine

## Parameters and Dialog Box

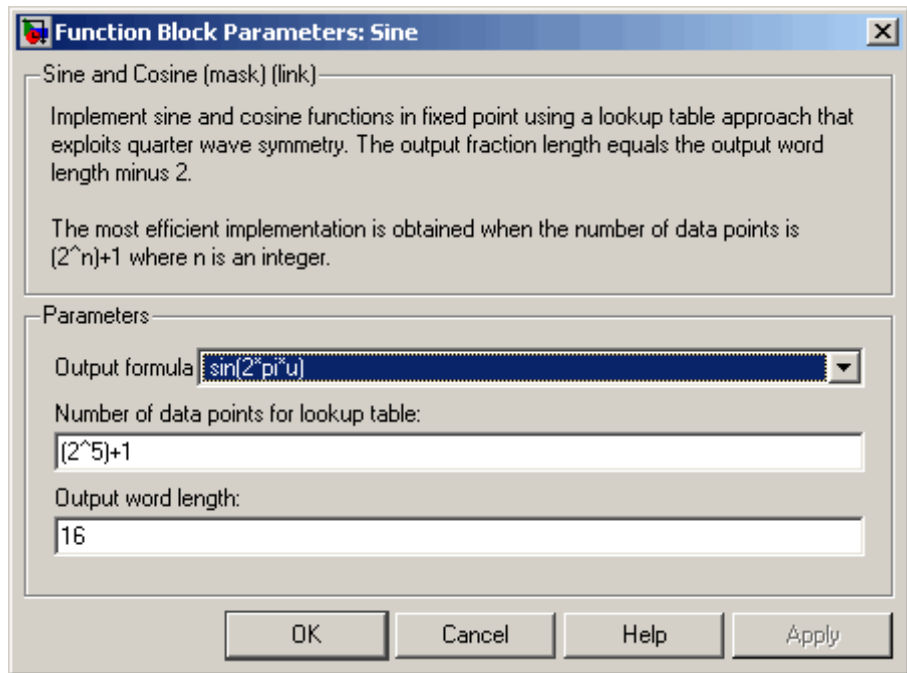

### Output formula

Select the signal(s) to output.

### Number of data points for lookup table

Specify the number of data points to retrieve from the lookup table. The implementation is most efficient when you specify the lookup table data points to be  $(2^n)+1$ , where  $n$  is an integer.

### Output word length

Specify the word length for the fixed-point data type of the output signal. The fraction length of the output is the output word length minus 2.

<b>Characteristics</b>	Direct Feedthrough	Yes
	Scalar Expansion	N/A

# Sine Wave

---

**Purpose** Generate sine wave

**Library** Sources

**Description** The Sine Wave block provides a sinusoid. The block can operate in either time-based or sample-based mode.



## Time-Based Mode

The output of the Sine Wave block is determined by

$$y = \textit{Amplitude} \times \sin(\textit{frequency} \times \textit{time} + \textit{phase}) + \textit{bias}$$

Time-based mode has two submodes: continuous mode or discrete mode. The value of the **Sample time** parameter determines whether the block operates in continuous mode or discrete mode:

- 0 (the default) causes the block to operate in continuous mode.
- >0 causes the block to operate in discrete mode.

See “Specifying Sample Time” in the online documentation for more information.

## Using the Sine Wave Block in Continuous Mode

A **Sample time** parameter value of 0 causes the block to operate in continuous mode. When operating in continuous mode, the Sine Wave block can become inaccurate due to loss of precision as time becomes very large.

## Using the Sine Wave Block in Discrete Mode

A **Sample time** parameter value greater than zero causes the block to behave as if it were driving a Zero-Order Hold block whose sample time is set to that value.

Using the Sine Wave block in this way allows you to build models with sine wave sources that are purely discrete, rather than models that are hybrid continuous/discrete systems. Hybrid systems are inherently more complex and as a result take longer to simulate.



The Sine Wave block in discrete mode uses an incremental algorithm rather than one based on absolute time. As a result, the block can be useful in models intended to run for an indefinite length of time, such as in vibration or fatigue testing.

The incremental algorithm computes the sine based on the value computed at the previous sample time. This method makes use of the following identities:

$$\begin{aligned}\sin(t + \Delta t) &= \sin(t) \cos(\Delta t) + \sin(\Delta t) \cos(t) \\ \cos(t + \Delta t) &= \cos(t) \cos(\Delta t) - \sin(t) \sin(\Delta t)\end{aligned}$$

These identities can be written in matrix form:

$$\begin{bmatrix} \sin(t + \Delta t) \\ \cos(t + \Delta t) \end{bmatrix} = \begin{bmatrix} \cos(\Delta t) & \sin(\Delta t) \\ -\sin(\Delta t) & \cos(\Delta t) \end{bmatrix} \begin{bmatrix} \sin(t) \\ \cos(t) \end{bmatrix}$$

Since  $\Delta t$  is constant, the following expression is a constant:

$$\begin{bmatrix} \cos(\Delta t) & \sin(\Delta t) \\ -\sin(\Delta t) & \cos(\Delta t) \end{bmatrix}$$

Therefore the problem becomes one of a matrix multiplication of the value of  $\sin(t)$  by a constant matrix to obtain  $\sin(t + \Delta t)$ .

Discrete mode reduces but does not eliminate accumulation of roundoff errors. This is because the computation of the block's output at each time step depends on the value of the output at the previous time step.

## Sample-Based Mode

Sample-based mode uses the following formula to compute the output of the Sine Wave block.

$$y = A \times \sin(2 \times \pi \times (k + o) / p) + b$$

where

- $A$  is the amplitude of the sine wave.

# Sine Wave

---

- $p$  is the number of time samples per sine wave period.
- $k$  is a repeating integer value that ranges from 0 to  $p-1$ .
- $o$  is the offset (phase shift) of the signal.
- $b$  is the signal bias.

In this mode, Simulink sets  $k$  equal to 0 at the first time step and computes the block's output, using the preceding formula. At the next time step, Simulink increments  $k$  and recomputes the output of the block. When  $k$  reaches  $p$ , Simulink resets  $k$  to 0 before computing the block's output. This process continues until the end of the simulation.

The sample-based method of computing the block's output does not depend on the result of the previous time step to compute the result at the current time step. It therefore avoids roundoff error accumulation. However, it has one potential drawback. If the block is in a conditionally executed subsystem and the conditionally executed subsystem pauses and then resumes execution, the output of the Sine Wave block might no longer be in sync with the rest of the simulation. Thus, if the accuracy of your model requires that the output of conditionally executed Sine Wave blocks remain in sync with the rest of the model, you should use time-based mode for computing the output of the conditionally executed blocks.

## Parameter Dimensions

The block's numeric parameters must be of the same dimensions after scalar expansion. If the **Interpret vector parameters as 1-D** option is off, the block outputs a signal of the same dimensions and dimensionality as the parameters. If the **Interpret vector parameters as 1-D** option is on and the numeric parameters are row or column vectors (i.e., single row or column 2-D arrays), the block outputs a vector (1-D array) signal; otherwise, the block outputs a signal of the same dimensionality and dimensions as the parameters.

## Data Type Support

The Sine Wave block accepts and outputs real signals of type double.

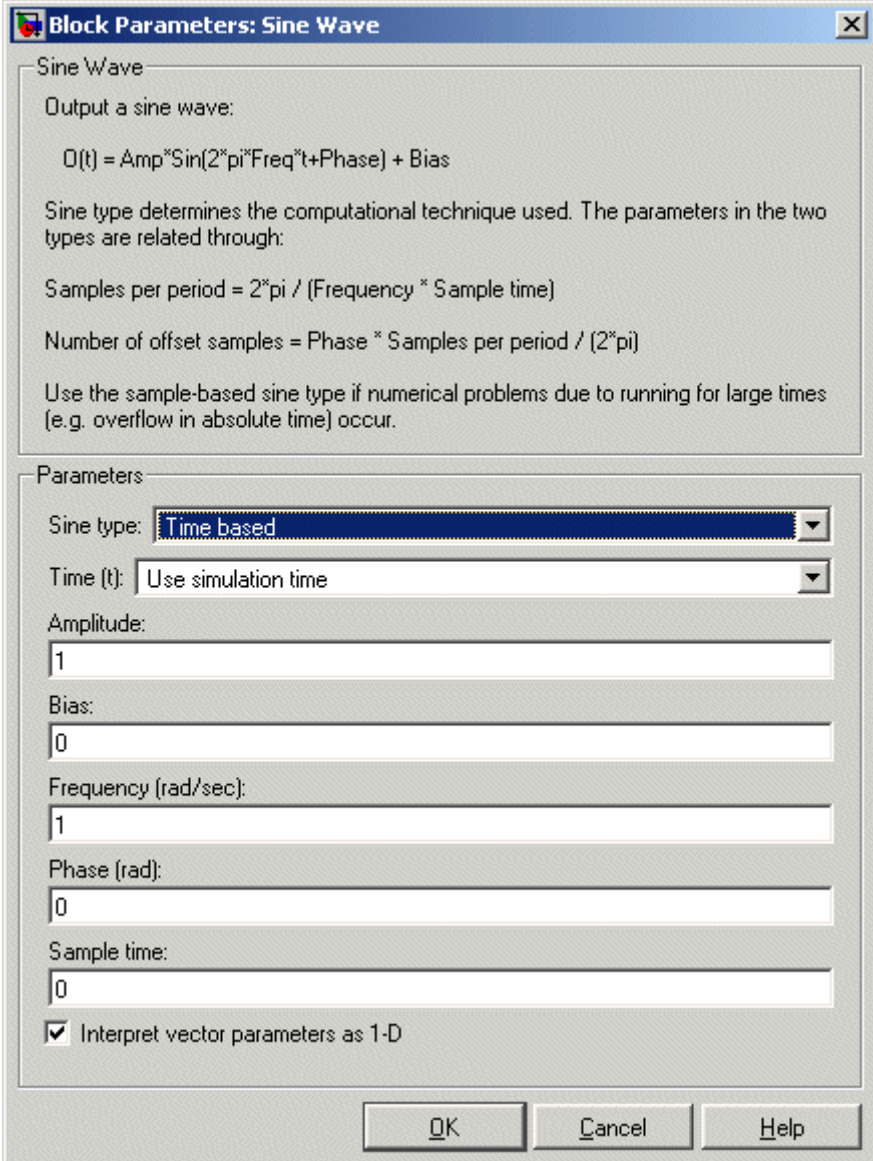
**Parameters  
and  
Dialog  
Box**

**Block Parameters: Sine Wave**

Sine Wave

Output a sine wave:

$$O(t) = \text{Amp} * \text{Sin}(2 * \text{pi} * \text{Freq} * t + \text{Phase}) + \text{Bias}$$

Sine type determines the computational technique used. The parameters in the two types are related through:

$$\text{Samples per period} = 2 * \text{pi} / (\text{Frequency} * \text{Sample time})$$
$$\text{Number of offset samples} = \text{Phase} * \text{Samples per period} / (2 * \text{pi})$$

Use the sample-based sine type if numerical problems due to running for large times (e.g. overflow in absolute time) occur.

Parameters

Sine type: **Time based**

Time (t): **Use simulation time**

Amplitude: **1**

Bias: **0**

Frequency (rad/sec): **1**

Phase (rad): **0**

Sample time: **0**

Interpret vector parameters as 1-D

**OK** **Cancel** **Help**

# Sine Wave

---

Opening this dialog box causes a running simulation to pause. See “Changing Source Block Parameters During Simulation” in the online Simulink documentation for details.

## **Sine type**

Type of sine wave generated by this block, either time- or sample-based. Some of the other options presented by the Sine Wave dialog box depend on whether you select time-based or sample-based as the value of **Sine type** parameter.

## **Time**

Specifies whether to use simulation time as the source of values for the sine wave’s time variable or an external source. If you specify an external time source, the block displays an input port for the time source.

## **Amplitude**

The amplitude of the signal. The default is 1.

## **Bias**

Constant value added to the sine to produce the output of this block.

## **Frequency**

The frequency, in radians/second. The default is 1 rad/s. This parameter appears only if you choose time-based as the **Sine type** of the block.

## **Samples per period**

Number of samples per period. This parameter appears only if you choose sample-based as the **Sine type** of the block.

## **Phase**

The phase shift, in radians. The default is 0 radians. This parameter appears only if you choose time-based as the **Sine type** of the block.

## Number of offset samples

The offset (discrete phase shift) in number of sample times. This parameter appears only if you choose sample-based as the **Sine type** of the block.

## Sample time

The sample period. The default is 0. If the sine type is sample-based, the sample time must be greater than 0. See “Specifying Sample Time” in the online documentation for more information.

## Interpret vector parameters as 1-D

If selected, column or row matrix values for the Sine Wave block’s numeric parameters result in a vector output signal; otherwise, the block outputs a signal of the same dimensionality as the parameters. If this option is not selected, the block always outputs a signal of the same dimensionality as the block’s numeric parameters. See “Determining the Output Dimensions of Source Blocks” in the “Working with Signals” chapter of the Using Simulink documentation. This option is not available when an external signal specifies time. In this case, if the block’s numeric parameters are column or row matrix values, the output is a 1-D vector.

## Characteristics

Sample Time	Specified in the <b>Sample time</b> parameter
Scalar Expansion	Yes, of parameters
Dimensionalized	Yes
Zero Crossing	No

# Sine Wave Function

---

**Purpose** Generate sine wave, using external signal as time source

**Library** Math Operations

**Description** This block is the same as the Sine Wave block with its **Time** parameter set to Use external source. See the documentation for the Sine Wave block for more information.

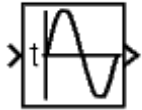

**Purpose** Vary scalar gain using slider

**Library** Math Operations

**Description** The Slider Gain block allows you to vary a scalar gain during a simulation using a slider. The block accepts one input and generates one output.

**Data Type Support** Data type support for the Slider Gain block is the same as that for the Gain block (see Gain).

## Parameters and Dialog Box

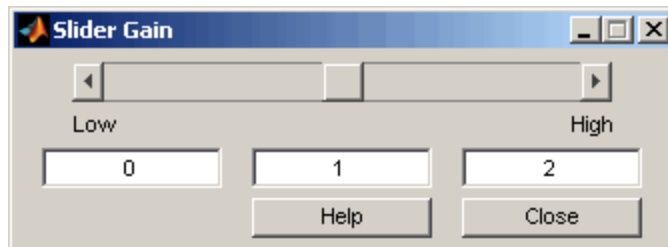

### Low

The lower limit of the slider range. The default is 0.

### High

The upper limit of the slider range. The default is 2.

The edit fields indicate (from left to right) the lower limit, the current value, and the upper limit. You can change the gain in two ways: by manipulating the slider, or by entering a new value in the current value field. You can change the range of gain values by changing the lower and upper limits. Close the dialog box by clicking the **Close** button.

If you click the slider's left or right arrow, the current value changes by about 1% of the slider's range. If you click the rectangular area to either side of the slider's indicator, the current value changes by about 10% of the slider's range.

# Slider Gain

---

To apply a vector or matrix gain to the block input, consider using the Gain block.

<b>Characteristics</b>	
Direct Feedthrough	Yes
Sample Time	Inherited from driving block
Scalar Expansion	Yes, of the gain
States	0
Dimensionalized	Yes
Multidimensionalized	Yes
Zero Crossing	No



**Purpose** Remove singleton dimensions from multidimensional signal

**Library** Math Operations

**Description**

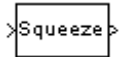

The Squeeze block removes singleton dimensions from its multidimensional input signal. A singleton dimension is any dimension whose size is one.

---

**Note** The Squeeze block operates only on signals whose number of dimensions is greater than two. Scalar, one-dimensional (vector), and two-dimensional (matrix) signals pass through the Squeeze block unchanged.

---

For example, the Squeeze block in the following diagram converts a multidimensional array of size 3-by-1-by-2 into a 3-by-2 signal.

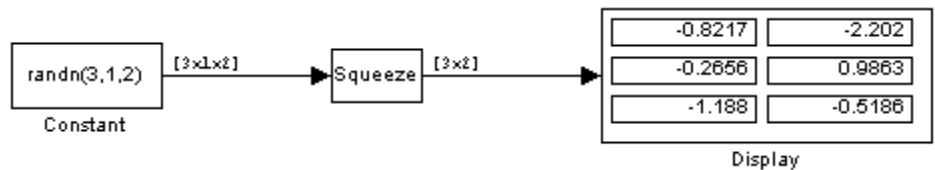

**Data Type Support**

The Squeeze block accepts input signals of any dimension and of any data type that Simulink supports, including fixed-point data types. For a discussion on the data types supported by Simulink, see “Data Types Supported by Simulink”.

# Squeeze

## Parameters and Dialog Box

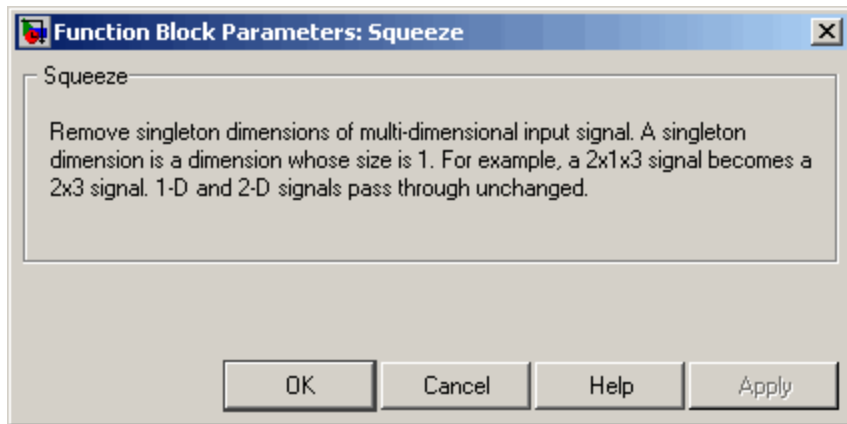

## Characteristics

Direct Feedthrough	Yes
Sample Time	Inherited from driving block
Scalar Expansion	N/A
Dimensionalized	Yes
Multidimensionalized	Yes
Zero Crossing	No

## See Also

Reshape

**Purpose** Implement linear state-space system

**Library** Continuous

**Description** The State-Space block implements a system whose behavior is defined by

$$\begin{array}{l} \dot{x} = Ax + Bu \\ y = Cx + Du \end{array}$$

$$\begin{array}{l} \dot{x} = Ax + Bu \\ y = Cx + Du \end{array}$$

where  $x$  is the state vector,  $u$  is the input vector, and  $y$  is the output vector. The matrix coefficients must have these characteristics, as illustrated in the following diagram:

- **A** must be an n-by-n matrix, where n is the number of states.
- **B** must be an n-by-m matrix, where m is the number of inputs.
- **C** must be an r-by-n matrix, where r is the number of outputs.
- **D** must be an r-by-m matrix.

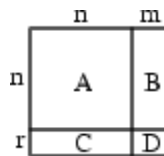

The block accepts one input and generates one output. The input vector width is determined by the number of columns in the B and D matrices. The output vector width is determined by the number of rows in the C and D matrices.

Simulink converts a matrix containing zeros to a sparse matrix for efficient multiplication.

### Specifying the Absolute Tolerance for the Block's States

By default Simulink uses the absolute tolerance value specified in the **Configuration Parameters** dialog box (see “Solver Pane”) to solve the

# State-Space

---

states of the State-Space block. If this value does not provide sufficient error control, specify a more appropriate value in the **Absolute tolerance** field of the State-Space block's dialog box. The value that you specify is used to solve all the block's states.

## Data Type Support

A State-Space block accepts and outputs real signals of type double.

## Parameters and Dialog Box

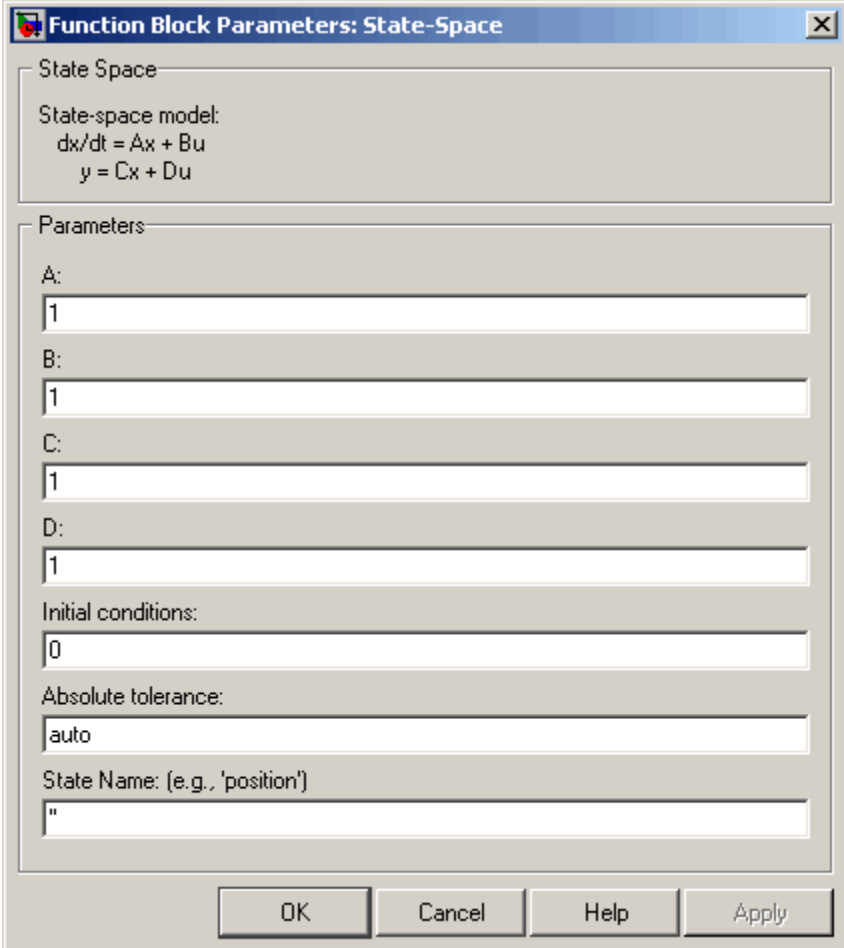

The dialog box is titled "Function Block Parameters: State-Space". It contains the following fields:

- State Space**  
State-space model:  
 $dx/dt = Ax + Bu$   
 $y = Cx + Du$
- Parameters**
  - A: [1]
  - B: [1]
  - C: [1]
  - D: [1]
  - Initial conditions: [0]
  - Absolute tolerance: [auto]
  - State Name: (e.g., 'position') [ ]

Buttons: OK, Cancel, Help, Apply

### A, B, C, D

The matrix coefficients.

### Initial conditions

The initial state vector. Simulink does not allow the initial conditions of this block to be `inf` or `NaN`.

# State-Space

---

## Absolute tolerance

Absolute tolerance used to solve the block's states. You can enter auto or a numeric value. If you enter auto, Simulink determines the absolute tolerance (see "Solver Pane"). If you enter a numeric value, Simulink uses the specified value to solve the block's states. Note that a numeric value overrides the setting for the absolute tolerance in the **Configuration Parameters** dialog box.

## State Name

Use this to assign a unique name to each state. The state names apply only to the selected block. If left blank, no name is assigned.

To assign a name to a single state, enter the name between quotes, for example, 'velocity'.

To assign names to multiple states, enter a comma-delimited list surrounded by braces. For example, {'a', 'b', 'c'}. Each name must be unique.

The number of states must be evenly divided by the number of state names. There can be fewer names than the number of states, but there cannot be more names than states.

For example, you can specify two names in a system with four states. Simulink will assign the first name to the first two states and the second name to the last two.

To assign state names with a variable that has been defined in the MATLAB workspace, enter the variable without quotes. A variable can be a string, cell, or structure.

## Characteristics

Direct Feedthrough	Only if $D \neq 0$
Sample Time	Continuous
Scalar Expansion	Yes, of the initial conditions

States	Depends on the size of A
Dimensionalized	Yes
Zero Crossing	No

# Step

---

**Purpose** Generate step function

**Library** Sources

## Description



The Step block provides a step between two definable levels at a specified time. If the simulation time is less than the **Step time** parameter value, the block's output is the **Initial value** parameter value. For simulation time greater than or equal to the **Step time**, the output is the **Final value** parameter value.

The block's numeric parameters must be of the same dimensions after scalar expansion. If the **Interpret vector parameters as 1-D** option is off, the block outputs a signal of the same dimensions and dimensionality as the parameters. If the **Interpret vector parameters as 1-D** option is on and the numeric parameters are row or column vectors (i.e., single row or column 2-D arrays), the block outputs a vector (1-D array) signal; otherwise, the block outputs a signal of the same dimensionality and dimensions as the parameters.

## Data Type Support

The Step block outputs real signals of type double.



## Parameters and Dialog Box

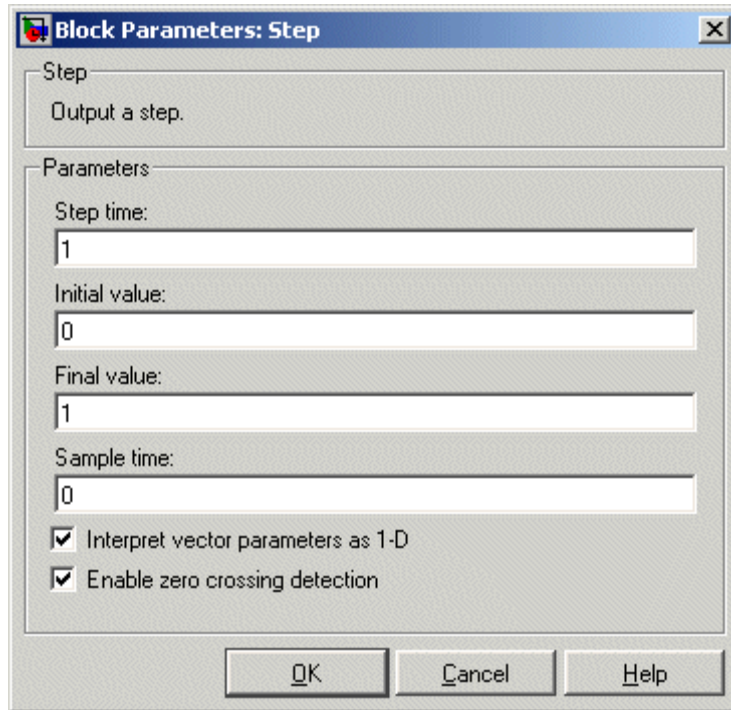

Opening this dialog box causes a running simulation to pause. See “Changing Source Block Parameters During Simulation” in the online Simulink documentation for details.

### Step time

The time, in seconds, when the output jumps from the **Initial value** parameter to the **Final value** parameter. The default is 1 second.

### Initial value

The block output until the simulation time reaches the **Step time** parameter. The default is 0.

# Step

---

## Final value

The block output when the simulation time reaches and exceeds the **Step time** parameter. The default is 1.

## Sample time

Sample rate of step. See “Specifying Sample Time” in the online documentation for more information.

## Interpret vector parameters as 1-D

If selected, column or row matrix values for the Step block’s numeric parameters result in a vector output signal; otherwise, the block outputs a signal of the same dimensionality as the parameters. If this option is not selected, the block always outputs a signal of the same dimensionality as the block’s numeric parameters. See “Determining the Output Dimensions of Source Blocks” in the “Working with Signals” chapter of the Using Simulink documentation.

## Enable zero crossing detection

Select to enable zero crossing detection to detect step times. For more information, see “Zero-Crossing Detection” in the “How Simulink Works” chapter of the Using Simulink documentation.

## Characteristics

Sample Time	Specified in the <b>Sample time</b> parameter
Scalar Expansion	Yes, of parameters
Dimensionalized	Yes
Zero Crossing	Yes, if enabled.

**Purpose** Stop simulation when input is nonzero

**Library** Sinks

**Description** The Stop Simulation block stops the simulation when the input is nonzero.

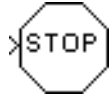

The simulation completes the current time step before terminating. If the block input is a vector, any nonzero vector element causes the simulation to stop.

You can use this block in conjunction with the Relational Operator block to control when the simulation stops. For example, this model stops the simulation when the input signal reaches 10.

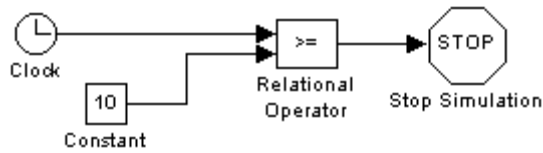

The Stop block cannot be used to pause the simulation. To create a block that pauses the simulation, see “Creating Pause Blocks” in Using Simulink for more information.

**Data Type Support** The Stop Simulation block accepts real signals of type double or Boolean.

# Stop Simulation

---

## Parameters and Dialog Box

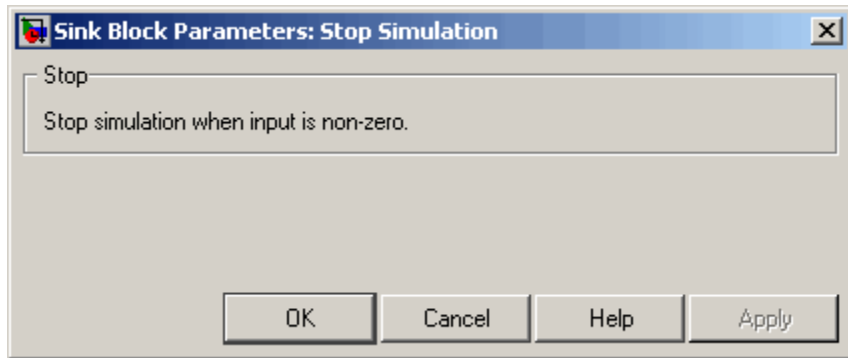

## Characteristics

Sample Time	Inherited from driving block
Dimensionalized	Yes

# Subsystem, Atomic Subsystem, CodeReuse Subsystem

---

**Purpose** Represent system within another system

**Library** Ports & Subsystems

## Description



A Subsystem block represents a subsystem of the system that contains it. The Subsystem block can represent a virtual subsystem or a true (atomic) subsystem, depending on the value of its **Treat as atomic unit** parameter. An Atomic Subsystem block is a Subsystem block that has its **Treat as atomic unit** parameter selected by default.

You create a subsystem in these ways:

- Copy the Subsystem (or Atomic Subsystem) block from the Ports & Subsystems library into your model. You can then add blocks to the subsystem by opening the Subsystem block and copying blocks into its window.
- Select the blocks and lines that are to make up the subsystem using a bounding box, then choose **Create Subsystem** from the **Edit** menu. Simulink replaces the blocks with a Subsystem block. When you open the block, the window displays the blocks you selected, adding Inport and Outport blocks to reflect signals entering and leaving the subsystem.

The number of input ports drawn on the Subsystem block's icon corresponds to the number of Inport blocks in the subsystem. Similarly, the number of output ports drawn on the block corresponds to the number of Outport blocks in the subsystem.

See “Creating Subsystems” for more information about subsystems.

## Data Type Support

For a discussion on the data types supported by Simulink, see “Data Types Supported by Simulink” in the Simulink documentation.

See Inport for information on the data types accepted by a subsystem's input ports. See Outport for information on the data types output by a subsystem's output ports.

# Subsystem, Atomic Subsystem, CodeReuse Subsystem

## Parameters and Dialog Box

**Function Block Parameters: Subsystem**

Subsystem  
Select the settings for the subsystem block.

Parameters

Show port labels: FromPortIcon

Read/Write permissions: ReadWrite

Name of error callback function:

Permit hierarchical resolution: All

Treat as atomic unit

Minimize algebraic loop occurrences

Sample time (-1 for inherited): -1

Real-Time Workshop system code: Auto

OK Cancel Help Apply

### Show port labels

Causes Simulink to display labels for the subsystem's ports on the subsystem's icon. Options include:

# Subsystem, Atomic Subsystem, CodeReuse Subsystem

---

Option	Description
none	Do not display port labels on the subsystem block.
FromPortIcon	If the corresponding port icon displays a signal name, display the signal name on the subsystem block. Otherwise, display the port block's name.
FromPortBlockName	Display the name of the corresponding port block on the subsystem block.
Signal Name	Display the name of the signal connected to the port on the subsystem block, if a name exists, otherwise, the name of the corresponding port block.

## Read/Write permissions

Controls user access to the contents of the subsystem. You can select any of the following values.

# Subsystem, Atomic Subsystem, CodeReuse Subsystem

---

Permissions	Description
ReadWrite	User can open and modify the contents of the subsystem.
ReadOnly	User can open but not modify the subsystem. If the subsystem resides in a block library, a user can create and open links to the subsystem and can make and modify local copies of the subsystem but cannot change the permissions or modify the contents of the original library instance.
NoReadOrWrite	User cannot open or modify the subsystem. If the subsystem resides in a library, a user can create links to the subsystem in a model but cannot open, modify, change permissions, or create local copies of the subsystem.

## **Name of error callback function**

Name of a function to be called if an error occurs while Simulink is executing the subsystem. Simulink passes two arguments to the function: the handle of the subsystem and a string that specifies the error type. If no function is specified, Simulink displays a generic error message if executing the subsystem causes an error.

## **Permit hierarchical resolution**

Specifies whether to resolve names of workspace variables referenced by this subsystem. The options are

- All

Resolve all names of workspace variables used by this subsystem, including those used to specify block parameter values and Simulink data objects (for example, `Simulink.Signal` objects).



# Subsystem, Atomic Subsystem, CodeReuse Subsystem

---

- **ExplicitOnly**

Resolve only names of workspace variables used to specify block parameter values, data store memory (where no block exists), signals, and states marked as “must resolve”.

- **None**

Do not resolve any workspace variable names.

### **Treat as atomic unit**

Causes Simulink to treat the subsystem as a unit when determining the execution order of block methods. For example, when it needs to compute the output of the subsystem, Simulink invokes the output methods of all the blocks in the subsystem before invoking the output methods of other blocks at the same level as the subsystem block. If this option is not selected, Simulink treats all blocks in the subsystem as being at the same level in the model hierarchy as the subsystem when determining block method execution order. This can cause execution of methods of blocks in the subsystem to be interleaved with execution of methods of blocks outside the subsystem. See “Atomic Subsystems” for more information.

### **Minimize algebraic loop occurrences**

This option appears only if the subsystem is atomic. If selected, this option tries to eliminate any algebraic loops that include the subsystem (see “Eliminating Algebraic Loops” in the online Simulink documentation for more information).

### **Propagate execution context across subsystem boundary**

This option appears only if the subsystem is conditionally executed.

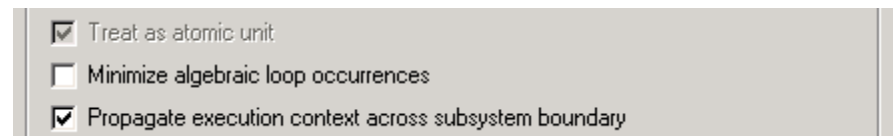

# Subsystem, Atomic Subsystem, CodeReuse Subsystem

---

If selected, this option enables execution context propagation across this subsystem's boundary (see "Propagating Execution Contexts" in the online Simulink documentation). Simulink disables this option by default.

## **Warn if function-call inputs are context-specific**

This option appears only if the subsystem is a function-call subsystem.

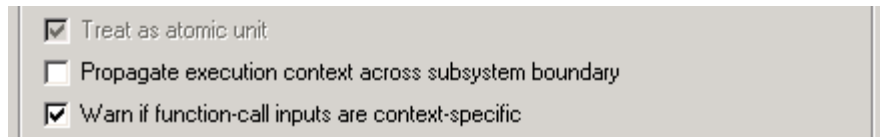

The option is effective only if the **Context-dependent inputs** diagnostic on the **Configuration Parameters > Connectivity** dialog box is set to Use local settings. In this case, if this option is checked, Simulink displays a warning if it has to compute any of this function-call subsystem's inputs directly or indirectly during execution of a function-call (see the "Function-call systems" examples in the Simulink "Subsystem Semantics" library for examples of such function-call subsystems).

## **Sample time**

Specifies the sample time of this subsystem if it is atomic, i.e., its **Treat as atomic unit** option is selected. The sample time that you specify must be one of the following:

- Inherited Sample Time (-1), the default
- Constant Sample Time (inf)
- Periodic ([Ts 0])

Use this parameter to specify whether all blocks in this subsystem must run at the same rate or can run at different rates. If the blocks in the subsystem can run at different rates, specify the subsystem's sample time as inherited (-1). If all blocks must run

# Subsystem, Atomic Subsystem, CodeReuse Subsystem

at the same rate, specify the sample time corresponding to this rate as the value of the subsystem's **Sample time** parameter. If any of the blocks in the subsystem specify a different sample time (other than -1 or `inf`), Simulink displays an error message when you update or simulate the model. For example, suppose all the blocks in the subsystem must run 5 times a second. To ensure this, specify the sample time of the subsystem as 0.2. In this example, if any of the blocks in the subsystem specify a sample time other than 0.2, -1, or `inf`, Simulink displays an error when you update or simulate the model.

**Real-Time Workshop system code** (Real-Time Workshop license required)

Specifies the code format to be generated for an atomic (nonvirtual) subsystem.

<b>If You Want Real-Time Workshop to...</b>	<b>Select...</b>
Choose the optimal format for you based on the type and number of instances of the subsystem that exist in the model	Auto
Inline the subsystem unconditionally	Inline
Generate a separate, non-reentrant function with no arguments, and optionally place the subsystem code in a separate file	Function
Generates a function with arguments that allows the subsystem's code to be shared by other instances of it in the model	Reusable function

# Subsystem, Atomic Subsystem, CodeReuse Subsystem

---

When this option is set to `Function` or `Reusable function`, two additional options appear — **Real-Time Workshop function name options** and **Real-Time Workshop file name options**.

For more information on using these options, see “Nonvirtual Subsystem Code Generation Options” in the Real-Time Workshop documentation.

**Real-Time Workshop function name options** (Real-Time Workshop license required)

Specifies how Real-Time Workshop is to name the function it generates for the subsystem.

<b>If You Want Real-Time Workshop to...</b>	<b>Select...</b>
Assign a unique function name using the default naming convention, <i>model_subsystem()</i> , where <i>model</i> is the name of the model and <i>subsystem</i> is the name of the subsystem (or that of an identical one when code is being reused)	Auto
Use the subsystem name as the function name	Use subsystem name
Assign a unique, valid C or C++ function name that you specify	User specified

If you specify `Use subsystem name` and the subsystem is a library block, Real-Time Workshop names the function (and filename) with the name of the library block, regardless of the names used for that subsystem in the model.

If you select `User specified`, a **Real-Time Workshop function name** option appears.

# Subsystem, Atomic Subsystem, CodeReuse Subsystem

**Real-Time Workshop function name** (Real-Time Workshop license required)

Specifies a unique, valid C or C++ function name for subsystem code.

**Real-Time Workshop file name options** (Real-Time Workshop license required)

Specifies how Real-Time Workshop is to name the separate file for the function it generates for the subsystem.

<b>If You Want Real-Time Workshop to...</b>	<b>Select...</b>
Generate the function code within the module generated from the subsystem's parent system, or, if the subsystem's parent is the model itself, within the file <code>model.c</code> or <code>model.cpp</code>	Auto
Generate a separate file and name it with the name of the subsystem or library block	Use subsystem name
Generate a separate file and name it with the function name you specify for <b>Real-Time Workshop function name options</b>	Use function name
Assign a unique, valid C or C++ function name that you specify	User specified

If you specify `Use subsystem name`, the subsystem filename is mangled if the model contains Model blocks, or if a model reference target is being generated for the model. In these situations, the filename for the subsystem consists of the subsystem name prefixed by the model name.

If you select `User specified`, the option **Real-Time Workshop filename (no extension)** option appears.

# Subsystem, Atomic Subsystem, CodeReuse Subsystem

---

**Real-Time Workshop file name (no extension)** (Real-Time Workshop license required)

Specifies how Real-Time Workshop is to name the file for the function it generates for the subsystem. The filename that you specify does not have to be unique. However, avoid giving non-unique names that result in cyclic dependencies (for example, `sys_a.h` includes `sys_b.h`, `sys_b.h` includes `sys_c.h`, and `sys_c.h` includes `sys_a.h`).

**Function with separate data** (Real-Time Workshop Embedded Coder license required)

Appears if you select Function for the **Real-Time Workshop system code** option. If checked, Real-Time Workshop Embedded Coder generates subsystem function code in which the internal data for an atomic subsystem is separated from its parent model and is owned by the subsystem. As a result, the generated code for the atomic subsystem is easier to trace and test. The data separation also tends to reduce the size of data structures throughout the model.

When you select this option, three memory section options for data appear: **Memory section for constants**, **Memory section for internal data**, and **Memory section for parameters**.

For details on how to generate modular function code for an atomic subsystem, see “Nonvirtual Subsystem Modular Function Code Generation” in the Real-Time Workshop Embedded Coder documentation.

For details on how to apply memory sections to atomic subsystems, see “Applying Memory Sections to Atomic Subsystems” in the Real-Time Workshop Embedded Coder documentation.

**Memory sections for initialize/terminate functions** (Real-Time Workshop Embedded Coder license required)

**Memory sections for execution functions**

Appear if you select Function for the **Real-Time Workshop system code** option. The value you specify for each of these

# Subsystem, Atomic Subsystem, CodeReuse Subsystem

options indicates how the Real-Time Workshop Embedded coder is to apply memory sections to the subsystem's initialization, termination, and execution functions. These options can be useful for overriding the model's memory section settings for the given subsystem.

The list of possible values varies depending on if and what package of memory sections you have set for the model's configuration (see "Configuring Memory Sections" in the Real-Time Workshop Embedded Coder documentation). If you have not configured the model with a package, `Inherit from model` is the only value that appears. Otherwise, the list includes `Default` and all memory sections the model's package contains.

<b>If You Want Real-Time Workshop Embedded Coder to...</b>	<b>Select...</b>
Apply the root model's memory sections to the subsystem's function code	<code>Inherit from model</code>
Not apply memory sections to the subsystem's system code, overriding any model-level specification	<code>Default</code>
Apply one of the model's memory sections to the subsystem	The memory section of interest

For details on how to apply memory sections to atomic subsystems, see "Applying Memory Sections to Atomic Subsystems" in the Real-Time Workshop Embedded Coder documentation.

**Memory sections for constants** (Real-Time Workshop Embedded Coder license required)

**Memory sections for internal data**

**Memory sections for parameters**

Appear if you select `Function` for the **Real-Time Workshop system code** option. The value you specify for each of these

# Subsystem, Atomic Subsystem, CodeReuse Subsystem

options indicates how the Real-Time Workshop Embedded Coder is to apply memory sections to the subsystem's data. These options can be useful for overriding the model's memory section settings for the given subsystem.

The list of possible values varies depending on if and what package of memory sections you have set for the model's configuration (see "Configuring Memory Sections" in the Real-Time Workshop Embedded Coder documentation). If you have not configured the model with a package, `Inherit from model` is the only value that appears. Otherwise, the list includes `Default` and all memory sections the model's package contains.

<b>If You Want Real-Time Workshop Embedded Coder to...</b>	<b>Select...</b>
Apply the root model's memory sections to the subsystem's data	<code>Inherit from model</code>
Not apply memory sections to the subsystem's data, overriding any model-level specification	<code>Default</code>
Apply one of the model's memory sections to the subsystem	The memory section of interest

For details on how to apply memory sections to atomic subsystems, see "Applying Memory Sections to Atomic Subsystems" in the Real-Time Workshop Embedded Coder documentation.

## Characteristics

Sample Time	Depends on the blocks in the subsystem
Dimensionalized	Depends on the blocks in the subsystem
Multidimensionalized	Depends on the blocks in the subsystem
Zero Crossing	Yes, for enable and trigger ports if present



# Sum, Add, Subtract, Sum of Elements

## Purpose

Add or subtract inputs

## Library

Math Operations

## Description

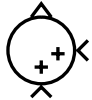

The Sum block performs addition or subtraction on its inputs. This block can add or subtract scalar, vector, or matrix inputs. It can also collapse the elements of a signal

You specify the operations of the block with the **List of signs** parameter. Plus (+), minus (-), and spacer (|) characters indicate the operations to be performed on the inputs:

- If there are two or more inputs, then the number of + and - characters must equal the number of inputs. For example, “+ -+” requires three inputs and configures the block to subtract the second (middle) input from the first (top) input, and then add the third (bottom) input.

All nonscalar inputs must have the same dimensions. Scalar inputs will be expanded to have the same dimensions as the other inputs.

- A spacer character creates extra space between ports on the block’s icon.
- If only addition of all inputs is required, then a numeric parameter value equal to the number of inputs can be supplied instead of “+” characters.
- If only one input port, a single “+” or “-” will collapse the element using the specified operation.

The Sum block first converts the input data type(s) to the output data type using the specified rounding and overflow modes, and then performs the specified operations.

## Data Type Support

The Sum block accepts real or complex signals of any data type supported by Simulink, including fixed-point data types. The inputs may be of different data types unless you select the **Require all inputs to have the same data type** parameter.

# Sum, Add, Subtract, Sum of Elements

For a discussion on the data types supported by Simulink, see “Data Types Supported by Simulink” in the Simulink documentation.

## Parameters and Dialog Box

The **Main** pane of the Sum block dialog appears as follows:

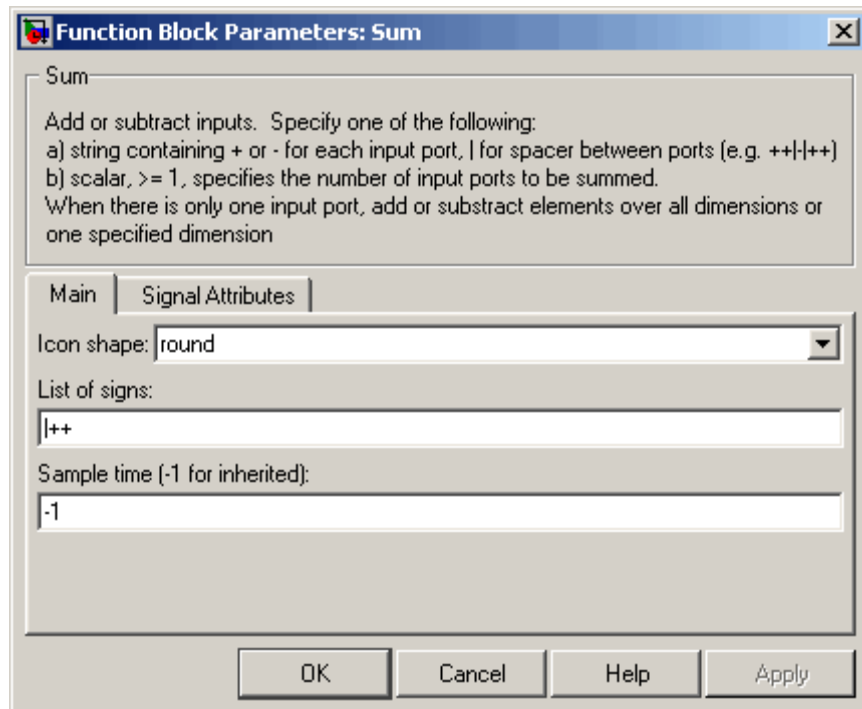

### Icon shape

Designate the icon shape of the block.

### List of signs

Enter as many plus (+) and minus (-) characters as there are inputs. Addition is the default operation, so if you only want to add the inputs, enter the number of input ports. For a single vector input, “+” or “-” will collapse the vector using the specified operation.

# Sum, Add, Subtract, Sum of Elements

---

You can manipulate the positions of the input ports on the block by inserting spacers (|) between the signs in the **List of signs** parameter. For example, “++| - -” creates an extra space between the second and third input ports.

## **Sum over** (Sum of Elements block)

This becomes visible on the **Main** pane when **List of signs** contains only one element.

Select **All** dimensions to sum all input elements, yielding a scalar.

Select **Specified** dimension to display the **Dimension** parameter, where you specify the dimension over which the operation is to be performed.

## **Dimension** (Sum of Elements block)

Specify the dimension over which the operation is to be performed.

The block follows the same summation rules as the MATLAB `sum` function.

For example, for a 2 x 3 matrix  $U$ , setting **Specified dimension** to 1 results in the output  $Y$  being computed as:

$$Y = \sum_{i=1}^2 U(i, j)$$

Setting **Specified dimension** to 2 results in  $Y$  being computed as:

$$Y = \sum_{j=1}^3 U(i, j)$$

If the specified dimension is greater than the dimension of the input, Simulink reports an error.

# Sum, Add, Subtract, Sum of Elements

## Sample time (-1 for inherited)

Specify the time interval between samples. To inherit the sample time, set this parameter to -1. See “Specifying Sample Time” in the online documentation for more information.

The **Signal Attributes** pane of the Sum block dialog appears as follows:

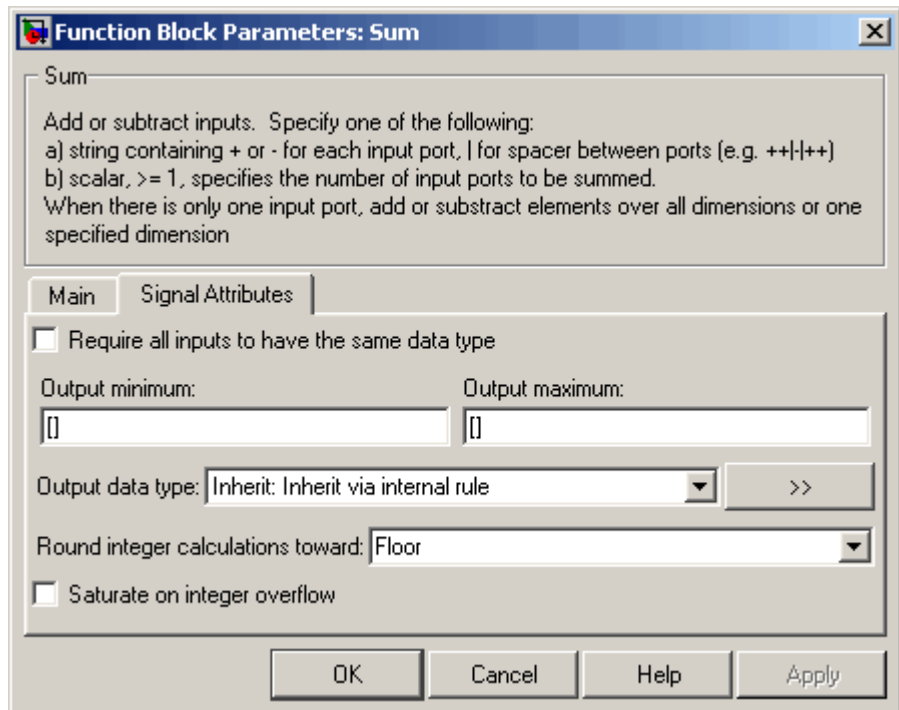

## Require all inputs to have the same data type

Select this parameter to require that all inputs must have the same data type.

## Output minimum

Specify the minimum value that the block should output. The default value, [], is equivalent to  $-\text{Inf}$ . Simulink uses this value to perform:

- Simulation range checking (see “Checking Signal Ranges”)
- Automatic scaling of fixed-point data types

## Output maximum

Specify the maximum value that the block should output. The default value, [], is equivalent to  $\text{Inf}$ . Simulink uses this value to perform:

- Simulation range checking (see “Checking Signal Ranges”)
- Automatic scaling of fixed-point data types

## Output data type

Specify the output data type. You can set it to:

- A rule that inherits a data type, for example, `Inherit`:  
`Inherit` via back propagation
- The name of a built-in data type, for example, `single`
- The name of a data type object, for example, a `Simulink.NumericType` object
- An expression that evaluates to a data type, for example, `float('single')`

Click the **Show data type assistant** button  to display the **Data Type Assistant**, which helps you set the **Output data type** parameter.

See “Specifying Block Output Data Types” in *Using Simulink* for more information.

## Lock output scaling against changes by the autoscaling tool

Select to lock scaling of outputs. This parameter is visible only if you enter an expression for the **Output data type** parameter.

# Sum, Add, Subtract, Sum of Elements

---

## **Round integer calculations toward**

Select the rounding mode for fixed-point operations.

## **Saturate on integer overflow**

Select to have overflows saturate.

## **Characteristics**

Direct Feedthrough	Yes
Sample Time	Specified in the <b>Sample time</b> parameter
Scalar Expansion	Yes
States	0
Dimensionalized	Yes
Multidimensionalized	Yes, only along the specified dimension
Zero Crossing	No

**Purpose** Switch output between first input and third input based on value of second input

**Library** Signal Routing

### Description



The Switch block passes through the first input or the third input based on the value of the second input. The first and third inputs are called *data inputs*. The second input is called the *control input*. (See “Changing the Orientation of a Block” in Using Simulink for a description of the port order for various block orientations.)

You select the conditions under which the first input is passed with the **Criteria for passing first input** parameter. You can make the block check whether the control input is greater than or equal to the threshold value, purely greater than the threshold value, or nonzero. If the control input meets the condition set in the **Criteria for passing first input** parameter, the first input is passed. Otherwise, the third input is passed.

---

**Note** If the data inputs to the switch are buses, the element names of both buses must be the same to ensure that the output bus has the same element names no matter which input bus is selected. You can ensure that your model meets this requirement by using a bus object to define the buses with the model’s **Element name mismatch** diagnostic set to error. See “Connectivity Diagnostics Overview” for more information.

---

### Data Type Support

The data and control inputs of a Switch block accept real or complex signals of any data type supported by Simulink, including fixed-point data types.

For a discussion on the data types supported by Simulink, see “Data Types Supported by Simulink” in the Simulink documentation.

# Switch

## Parameters and Dialog Box

The **Main** pane of the Switch block dialog appears as follows:

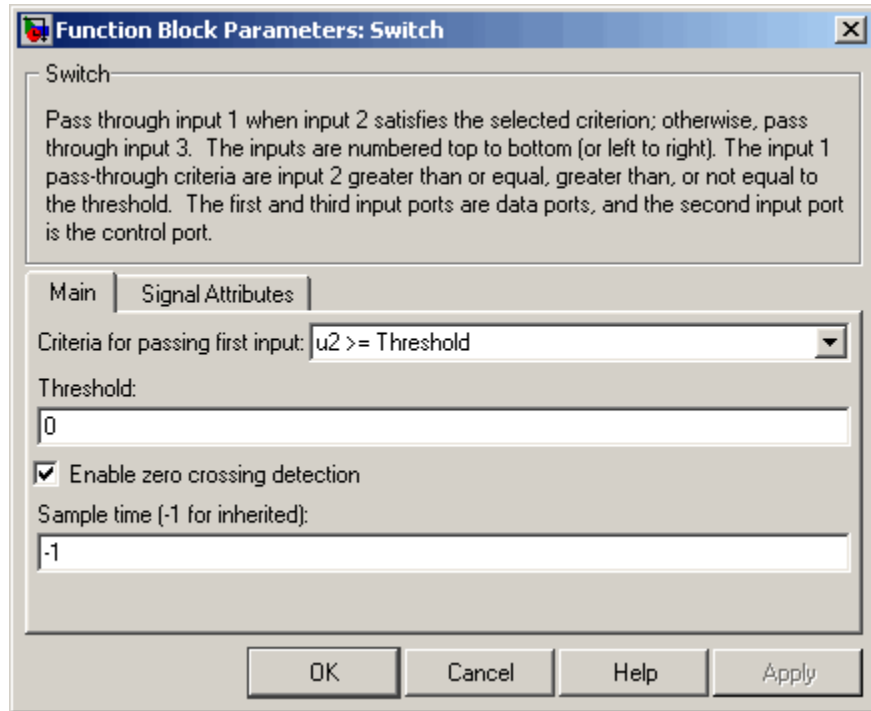

### Criteria for passing first input

Select the conditions under which the first input is passed. You can make the block check whether the control input is greater than or equal to the threshold value, purely greater than the threshold value, or nonzero. If the control input meets the condition set in this parameter, then the first input is passed. Otherwise, the third input is passed.

### Threshold

Assign the switch threshold that determines which input is passed to the output.



## Enable zero crossing detection

Select to enable zero crossing detection. For more information, see Zero Crossing Detection in the “How Simulink Works” chapter of the Using Simulink documentation.

## Sample time (-1 for inherited)

Specify the time interval between samples. To inherit the sample time, set this parameter to -1. See “Specifying Sample Time” in the online documentation for more information.

The **Signal Attributes** pane of the Switch block dialog appears as follows:

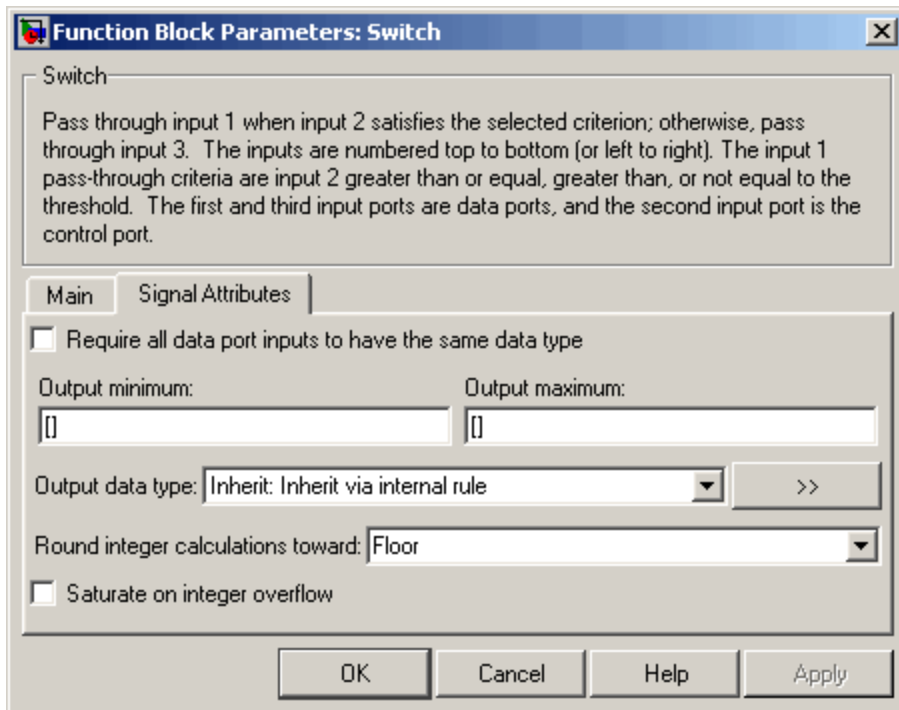

## **Require all data port inputs to have the same data type**

Select to require all data inputs to have the same data type.

## **Output minimum**

Specify the minimum value that the block should output. The default value, [], is equivalent to `-Inf`. Simulink uses this value to perform:

- Simulation range checking (see “Checking Signal Ranges”)
- Automatic scaling of fixed-point data types

## **Output maximum**

Specify the maximum value that the block should output. The default value, [], is equivalent to `Inf`. Simulink uses this value to perform:

- Simulation range checking (see “Checking Signal Ranges”)
- Automatic scaling of fixed-point data types

## **Output data type**

Specify the output data type. You can set it to:

- A rule that inherits a data type, for example, `Inherit: Inherit via back propagation`
- The name of a built-in data type, for example, `single`
- The name of a data type object, for example, a `Simulink.NumericType` object
- An expression that evaluates to a data type, for example, `float('single')`

Click the **Show data type assistant** button  to display the **Data Type Assistant**, which helps you set the **Output data type** parameter.

See “Specifying Block Output Data Types” in *Using Simulink* for more information.

**Lock output scaling against changes by the autoscaling tool**

Select to lock scaling of outputs. This parameter is visible only if you enter an expression for the **Output data type** parameter.

**Round integer calculations toward**

Select the rounding mode for fixed-point operations.

**Saturate on integer overflow**

Select to have overflows saturate.

**Bus Support**

The Switch block is a bus-capable block. The inputs can be virtual or nonvirtual bus signals subject to the following restrictions:

- The number of inputs must be greater than one.
- All inputs to the merge must be buses and must be equivalent (same hierarchy with identical names and attributes for all elements).

**Characteristics**

Bus-capable	Yes, with restrictions as noted above
Direct Feedthrough	Yes
Sample Time	Specified in the <b>Sample time</b> parameter
Scalar Expansion	Yes
Dimensionalized	Yes
Multidimensionalized	Yes
Zero Crossing	Yes, if enabled

**See Also**

Multiport Switch

# Switch Case

**Purpose** Implement C-like switch control flow statement

**Library** Ports & Subsystems

**Description** The following shows a completed Simulink C-like switch control flow statement in the subsystem of the Switch Case block.

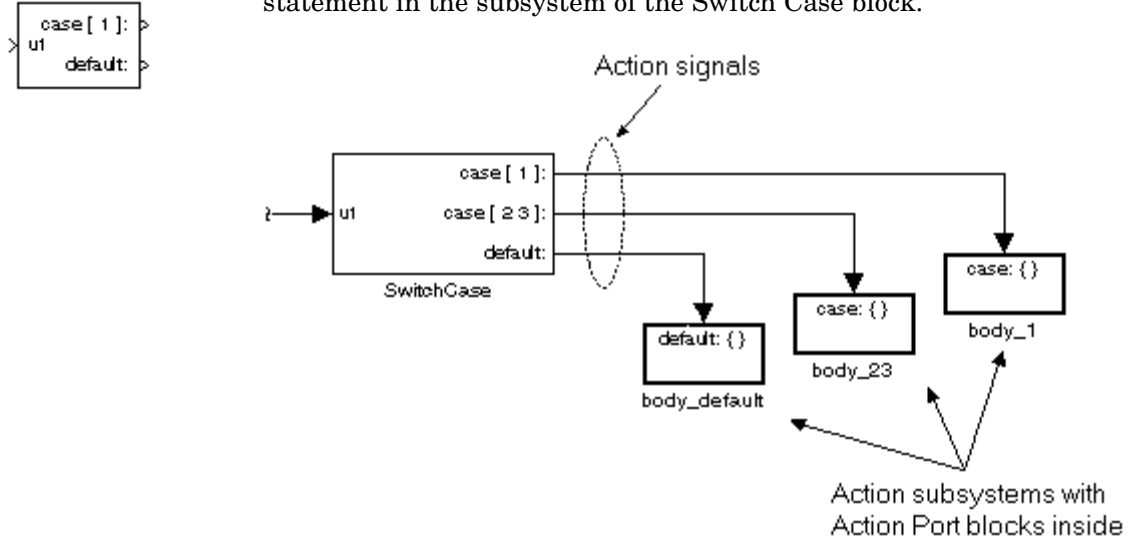

A Switch Case block receives a single input, which it uses to form case conditions that determine which subsystem to execute. Each output port case condition is attached to a Switch Case Action subsystem. The cases are evaluated top down starting with the top case. If a case value (in brackets) corresponds to the actual value of the input, its Switch Case Action subsystem is executed.

The preceding switch control flow statement can be represented by the following pseudocode:

```
switch (u1) {  
  case [u1=1]:  
    body_1;  
    break;  
}
```

```
case [u1=2 or u1=3]:
    body_23;
    break;
default:
    bodydefault;
}
```

You construct a Simulink switch control flow statement like the example shown as follows:

- 1 Place a Switch Case block in the current system and attach the input port labeled `u1` to the source of the data you are evaluating.
- 2 Open the **Block Parameters** dialog of the Switch Case block and enter as follows:

- a Enter the **Case conditions** field with the individual cases.

Each case can be an integer or set of integers specified with MATLAB cell notation. See the **Case conditions** field in the "Parameters and Dialog Box" section of this reference.

- b Select the **Show default case** check box to show a default case output port on the Switch Case block.

If all other cases are false, the default case is taken.

- 3 Create a Switch Case Action subsystem for each case port you added to the Switch Case block.

These consist of subsystems with Action Port blocks inside them. When you place the Action Port block inside a subsystem, the subsystem becomes an atomic subsystem with an input port labeled Action.

- 4 Connect each case output port and the default output port of the Switch Case block to the Action port of an Action subsystem.

# Switch Case

---

Each connected subsystem becomes a case body. This is indicated by the change in label for the Switch Case Action subsystem block and the Action Port block inside of it to the name `case{}`.

During simulation of a switch control flow statement, the Action signals from the Switch Case block to each Switch Case Action subsystem turn from solid to dashed.

- 5 In each Switch Case Action subsystem, enter the Simulink logic appropriate to the case it handles. All blocks in a Switch Case Action Subsystem must run at the same rate as the driving Switch Case block. You can achieve this by setting each block's sample time parameter to be either inherited (-1) or the same value as the Switch Case block's sample time.

---

**Note** As demonstrated in the preceding pseudocode example, cases for the Switch Case block contain an implied break after their Switch Case Action subsystems are executed. There is no fall-through behavior for the Simulink switch control flow statement as found in standard C switch statements.

---

## Data Type Support

Input to the port labeled `u1` of a Switch Case block can be a scalar value of any data type supported by Simulink except `Boolean`. The input to `u1` can also be a fixed-point data type. Noninteger inputs are truncated. For a discussion on the data types supported by Simulink, see "Data Types Supported by Simulink" in the Simulink documentation.

Data outputs are action signals to Switch Case Action subsystems that are created with Action Port blocks and subsystems.

## Parameters and Dialog Box

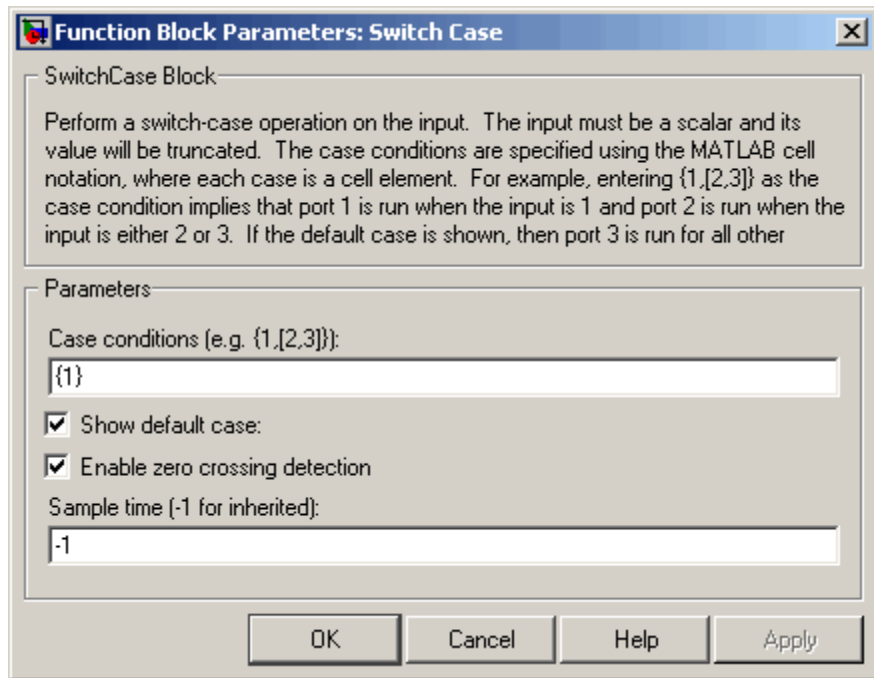

### Case conditions

Case conditions are specified using MATLAB cell notation where each cell is a case condition consisting of integers or arrays of integers. In the preceding dialog example, entering {1, [7,9,4]} specifies that output port case[1] is run when the input value is 1, and output port case[7 9 4] is run when the input value is 7, 9, or 4.

You can use colon notation to specify a range of case conditions. For example, entering {[1:5]} specifies that output port case[1 2 3 4 5] is run when the input value is 1, 2, 3, 4, or 5.

Depending on block size, cases with long lists of conditions are displayed in shortened form in the Switch Case block, using a terminating ellipsis (...).

# Switch Case

---

## Show default case

If you select this check box, the default output port appears as the last case on the Switch Case block. This case is run when the input value does not match any of the case values specified in the **Case conditions** field.

## Enable zero crossing detection

Select to enable use of zero crossing detection. For more information, see “Zero-Crossing Detection” in the “How Simulink Works” chapter of the Using Simulink documentation.

## Sample time (-1 for inherited)

Specify the time interval between samples. To inherit the sample time, set this parameter to -1. See “Specifying Sample Time” in the online documentation for more information.

## Characteristics

Direct Feedthrough	Yes
Sample Time	Inherited from driving block
Scalar Expansion	No
Dimensionalized	No
Zero Crossing	Yes, if enabled



# Switch Case Action Subsystem

---

## Purpose

Represent subsystem whose execution is triggered by Switch Case block

## Library

Ports & Subsystems

## Description

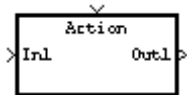

This block is a Subsystem block that is preconfigured to serve as a starting point for creating a subsystem whose execution is triggered by a Switch Case block.

---

**Note** All blocks in a Switch Case Action Subsystem must run at the same rate as the driving Switch Case block. You can achieve this by setting each block's sample time parameter to be either inherited (-1) or the same value as the Switch Case block's sample time.

---

For more information, see the Switch Case block and “Modeling Control Flow Logic” in the “Creating a Model” chapter of the Using Simulink documentation.

# Tapped Delay

---

<b>Purpose</b>	Delay scalar signal multiple sample periods and output all delayed versions
<b>Library</b>	Discrete
<b>Description</b>	<p>The Tapped Delay block delays its input by the specified number of sample periods, and outputs all the delayed versions.</p> <p>This block provides a mechanism for discretizing a signal in time, or resampling the signal at a different rate. You specify the time between samples with the <b>Sample time</b> parameter. You specify the number of delays with the <b>Number of delays</b> parameter. A value of -1 instructs the block to inherit the number of delays by backpropagation. Each delay is equivalent to the <math>z^{-1}</math> discrete-time operator, which is represented by the Unit Delay block.</p> <p>The block accepts one scalar input and generates an output for each delay. The input must be a scalar. You specify the order of the output vector with the <b>Order output vector starting with</b> parameter list. <b>Oldest</b> orders the output vector starting with the oldest delay version and ending with the newest delay version. <b>Newest</b> orders the output vector starting with the newest delay version and ending with the oldest delay version.</p> <p>The block output for the first sampling period is specified by the <b>Initial condition</b> parameter. Careful selection of this parameter can minimize unwanted output behavior.</p>
<b>Data Type Support</b>	The Tapped Delay block accepts signals of any data type supported by Simulink, including fixed-point data types.

## Parameters and Dialog Box

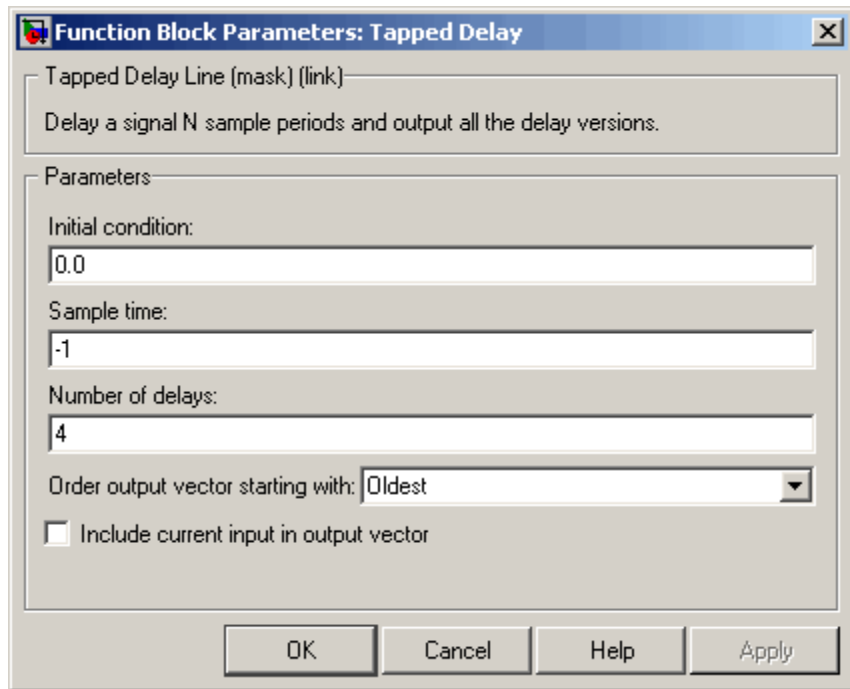

### Initial condition

Specify the initial output of the simulation. The **Initial condition** parameter is converted from a double to the input data type offline using round-to-nearest and saturation. Simulink does not allow you to set the initial condition of this block to `inf` or `NaN`.

### Sample time

Specify the time interval between samples. To inherit the sample time, set this parameter to `-1`. See "Specifying Sample Time" in the online documentation for more information.

### Number of delays

Specify the number of discrete-time operators.

# Tapped Delay

---

## **Order output vector starting with**

Specify whether the oldest delay version is output first, or the newest delay version is output first.

## **Include current input in output vector**

Select to include the current input in the output vector.

## **Characteristics**

Direct Feedthrough	Yes, when <b>Include current input in output vector</b> parameter is checked. No otherwise.
Sample Time	Specified in the <b>Sample time</b> parameter
Scalar Expansion	Yes, of initial conditions

**Purpose** Terminate unconnected output port

**Library** Sinks

**Description**



The Terminator block can be used to cap blocks whose output ports are not connected to other blocks. If you run a simulation with blocks having unconnected output ports, Simulink issues warning messages. Using Terminator blocks to cap those blocks avoids warning messages.

**Data Type Support**

The Terminator block accepts real or complex signals of any data type supported by Simulink, including fixed-point data types.

For a discussion on the data types supported by Simulink, see “Data Types Supported by Simulink” in the Simulink documentation.

**Parameters and Dialog Box**

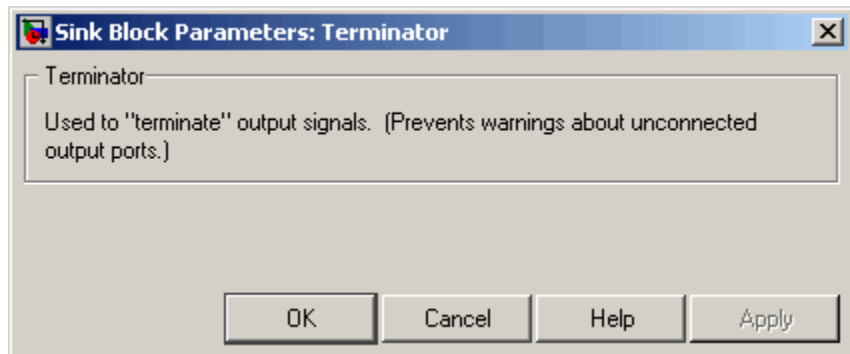

**Characteristics**

Sample Time	Inherited from driving block
Dimensionalized	Yes
Multidimensionalized	Yes

# Time-Based Linearization

---

**Purpose** Generate linear models in base workspace at specific times

**Library** Model-Wide Utilities

**Description**

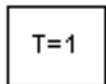

This block calls `linmod` or `dlinmod` to create a linear model for the system when the simulation clock reaches the time specified by the **Linearization time** parameter. No trimming is performed. The linear model is stored in the base workspace as a structure, along with information about the operating point at which the snapshot was taken. Multiple snapshots are appended to form an array of structures.

The block sets the following model parameters to the indicated values:

- `BufferReuse` = 'off'
- `RTWInlineParameters` = 'on'
- `BlockReductionOpt` = 'off'

The name of the structure used to save the snapshots is the name of the model appended by `_Timed_Based_Linearization`, for example, `vdp_Timed_Based_Linearization`. The structure has the follow fields:

Field	Description
<code>a</code>	The A matrix of the linearization
<code>b</code>	The B matrix of the linearization
<code>c</code>	The C matrix of the linearization
<code>d</code>	The D matrix of the linearization
<code>StateName</code>	Names of the model's states
<code>OutputName</code>	Names of the model's output ports
<code>InputName</code>	Names of the model's input ports

Field	Description
OperPoint	A structure that specifies the operating point of the linearization. The structure specifies the operating point time (OperPoint.t). The states (OperPoint.x) and inputs (OperPoint.u) fields are not used.
Ts	The sample time of the linearization for a discrete linearization

Use the Trigger-Based Linearization block if you need to generate linear models conditionally.

You can use state and simulation time logging to extract the model states and inputs at operating points. For example, suppose that you want to get the states of the f14 demo model at linearization times of 2 seconds and 5 seconds.

- 1 Open the model and drag an instance of this block from the Model-Wide Utilities library and drop the instance into the model.
- 2 Open the block's parameter dialog box and set the **Linearization time** to 2 and 5.
- 3 Open the model's **Configuration Parameters** dialog box.
- 4 Select the **Data Import/Export** pane.
- 5 Check **States** and **Time** on the **Save to Workspace** control panel
- 6 Select OK to confirm the selections and close the dialog box.
- 7 Simulate the model.

At the end of the simulation, the following variables appear in the MATLAB workspace: f14\_Timed\_Based\_Linearization, tout, and xout.

# Time-Based Linearization

- 8 Get the indices to the operating point times by entering the following at the MATLAB command line:

```
ind1 = find(f14_Timed_Based_Linearization(1).OperPoint.t==tout);  
ind2 = find(f14_Timed_Based_Linearization(1).OperPoint.t==tout);
```

- 9 Get the state vectors at the operating points.

```
x1 = xout(ind1,:);  
x2 = xout(ind2,:);
```

## Data Type Support

Not applicable.

## Parameters and Dialog Box

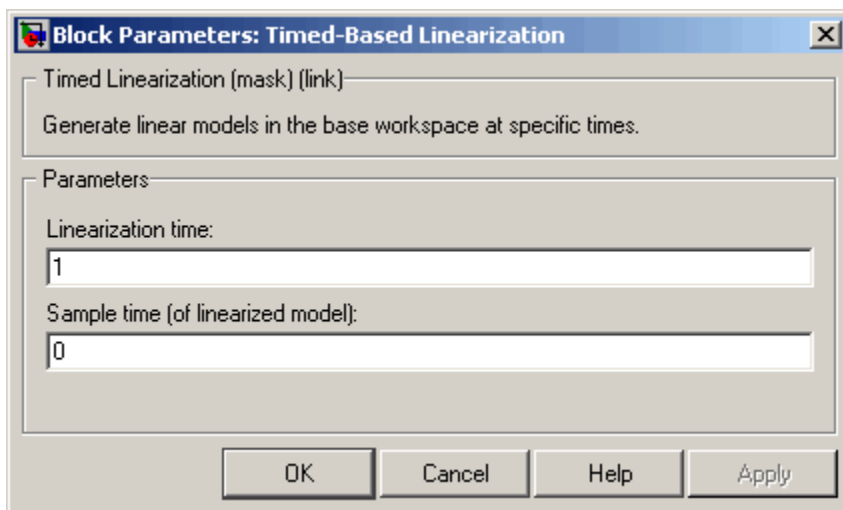

### Linearization time

Time at which you want the block to generate a linear model. Enter a vector of times if you want the block to generate linear models at more than one time step.



## Sample time (of linearized model)

Specify a sample time to create discrete-time linearizations of the model (see “Discrete-Time System Linearization” on page 4-99).

<b>Characteristics</b>	Sample Time	Specified in the <b>Sample time</b> parameter
	Dimensionalized	No

**See Also**      Trigger-Based Linearization

# To File

---

**Purpose** Write data to file

**Library** Sinks

**Description**



The To File block writes its scalar or vector input to a matrix in a MAT-file. The block writes the data as well as the simulation time after the simulation is completed. Its icon shows the name of the specified output file.

---

**Note** The To File block does not accept matrix signals.

---

For variable-step solvers, the **Output options** found on the “Data Import/Export Pane” pane of the Configuration Parameters dialog box determine the amount of data available to the To File block. For example, if you need to ensure that data is written at identical time points over multiple simulations, select the Produce specified output only option in the Configuration Parameters dialog box and enter the desired time vector.

Block parameters then control when and how much of this data the To File block writes:

- The **Decimation** parameter allows you to write data at every  $n$ th sample, where  $n$  is the decimation factor. The default decimation, 1, writes data at every time step.
- The **Sample time** parameter allows you to specify a sampling interval at which to collect points. This parameter is useful when you are using a variable-step solver where the interval between time steps might not be the same. The default value of -1 causes the block to inherit the sample time from the driving block when determining the points to write. See “Specifying Sample Time” in the online documentation for more information.

The block writes one column for each time step: the first row is the simulation time; the remainder of the column is the input data, one

data point for each element in the input vector. The matrix has the following form:

$$\begin{bmatrix} t_1 & t_2 & \dots & t_{final} \\ u1_1 & u1_2 & \dots & u1_{final} \\ \dots & & & \\ un_1 & un_2 & \dots & un_{final} \end{bmatrix}$$

The To File block generates an uncompressed MAT-file. If you open and save this file, it will be smaller because MATLAB compresses the saved file. If the file exists at the time the simulation starts, the block overwrites its contents.

The From File block can use data written by a To File block without any modifications. However, the form of the matrix expected by the From Workspace block is the transposition of the data written by the To File block.

## Data Type Support

The To File block accepts real signals of type double.

# To File

## Parameters and Dialog Box

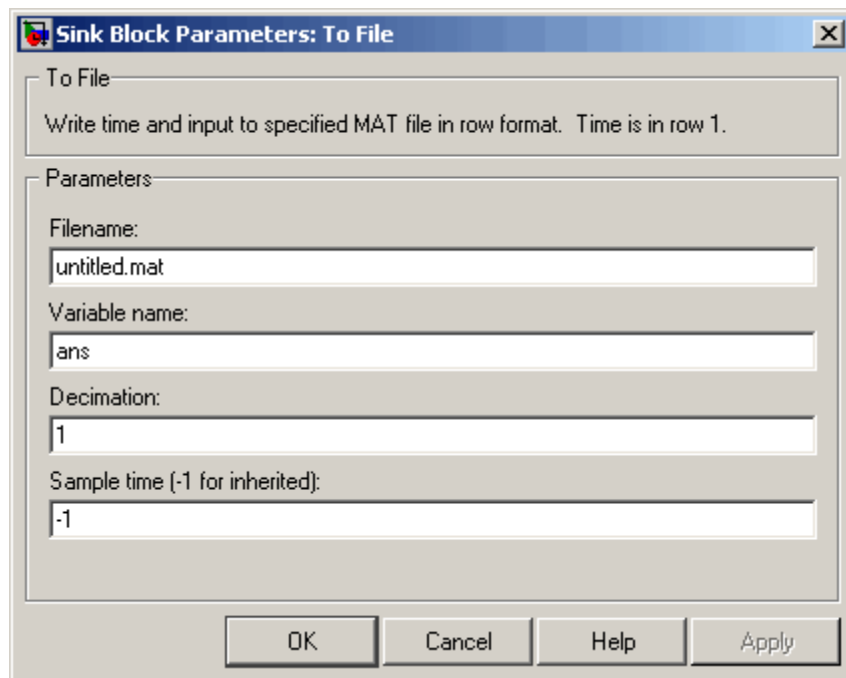

### Filename

The fully qualified pathname or filename of the MAT-file in which to store the output. On UNIX, the pathname may start with a tilde (~) character signifying your home directory. The default filename is `untitled.mat`. If you specify an unqualified filename, Simulink stores the file in the MATLAB working directory. (To determine the working directory, type `pwd` at the MATLAB command line.)

### Variable name

The name of the matrix contained in the named file.

### Decimation

A decimation factor. The default value is 1.

**Sample time**

The sample period and offset at which to collect points. See “Specifying Sample Time” in the online documentation for more information.

**Characteristics**

Sample Time	Specified in the <b>Sample time</b> parameter
Dimensionalized	Yes

# To Workspace

---

**Purpose** Write data to workspace

**Library** Sinks

## Description

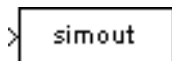

The To Workspace block writes its input to the workspace. The block writes its output to an array or structure that has the name specified by the block's **Variable name** parameter. The **Save format** parameter determines the output format.

### Array

Selecting this option causes the To Workspace block to save the input as an N-dimensional array where N is one more than the number of dimensions of the input signal. For example, if the input signal is a 1-D array (i.e., a vector), the resulting workspace array is two-dimensional. If the input signal is a 2-D array (i.e., a matrix), the array is three-dimensional.

The way samples are stored in the array depends on whether the input signal is a scalar or vector or a matrix. If the input is a scalar or a vector, each input sample is output as a row of the array. For example, suppose that the name of the output array is `simout`. Then, `simout(1,:)` corresponds to the first sample, `simout(2,:)` corresponds to the second sample, etc. If the input signal is a matrix, the third dimension of the workspace array corresponds to the values of the input signal at specified sampling point. For example, suppose again that `simout` is the name of the resulting workspace array. Then, `simout(:, :, 1)` is the value of the input signal at the first sample point; `simout(:, :, 2)` is the value of the input signal at the second sample point; etc.

For variable-step solvers, the **Output options** found on the **Data Import/Export** pane of the Configuration Parameters dialog box determine the amount of data available to the To Workspace block. For example, if you need to ensure that data is written at identical time points over multiple simulations, select the **Produce specified output only** option in the Configuration Parameters dialog box and enter the desired time vector.

Block parameters then control when and how much of this data the To Workspace block writes:

- The **Limit data points to last** parameter indicates how many sample points to save. If the simulation generates more data points than the specified maximum, the simulation saves only the most recently generated samples. To capture all the data, set this value to `inf`.
- The **Decimation** parameter allows you to write data at every  $n$ th sample, where  $n$  is the decimation factor. The default decimation, 1, writes data at every time step.
- The **Sample time** parameter allows you to specify a sampling interval at which to collect points. This parameter is useful when you are using a variable-step solver where the interval between time steps might not be the same. The default value of -1 causes the block to inherit the sample time from the driving block when determining the points to write. See “Specifying Sample Time” in the online documentation for more information.

During the simulation, the block writes data to an internal buffer. When the simulation is completed or paused, that data is written to the workspace. Its icon shows the name of the array to which the data is written.

### Structure

This format consists of a structure with three fields: `time`, `signals`, and `blockName`. The `time` field is empty. The `blockName` field contains the name of the To Workspace block. The `signals` field contains a structure with three fields: `values`, `dimensions`, and `label`. The `values` field contains the array of signal values. The `dimensions` field specifies the dimensions of the values array. The `label` field contains the label of the input line.

### Structure with Time

This format is the same as Structure except that the `time` field contains a vector of simulation time steps.

# To Workspace

---

---

**Note** This format does not support frame-based signals. Use Array or Structure format instead.

---

## Using Saved Data with a From Workspace Block

Use the Structure with Time format to save sample-based data if you intend to use a From Workspace block to play back the data in another simulation.

### Examples

In a simulation where the start time is 0, the **Limit data points to last** is 100, the **Decimation** is 1, and the **Sample time** is 0.5. The To Workspace block collects a maximum of 100 points, at time values of 0, 0.5, 1.0, 1.5, ..., seconds. Specifying a **Decimation** value of 1 directs the block to write data at each step.

In a similar example, the **Limit data points to last** is 100 and the **Sample time** is 0.5, but the **Decimation** is 5. In this example, the block collects up to 100 points, at time values of 0, 2.5, 5.0, 7.5, ..., seconds. Specifying a **Decimation** value of 5 directs the block to write data at every fifth sample. The sample time ensures that data is written at these points.

In another example, all parameters are as defined in the first example except that the **Limit data points to last** is 3. In this case, only the last three sample points collected are written to the workspace. If the simulation stop time is 100, data corresponds to times 99.0, 99.5, and 100.0 seconds (three points).

## Data Type Support

The To Workspace block can save real or complex inputs of any data type supported by Simulink, including fixed-point data types, to the MATLAB workspace.

For a discussion on the data types supported by Simulink, see “Data Types Supported by Simulink” in the Simulink documentation.



## Parameters and Dialog Box

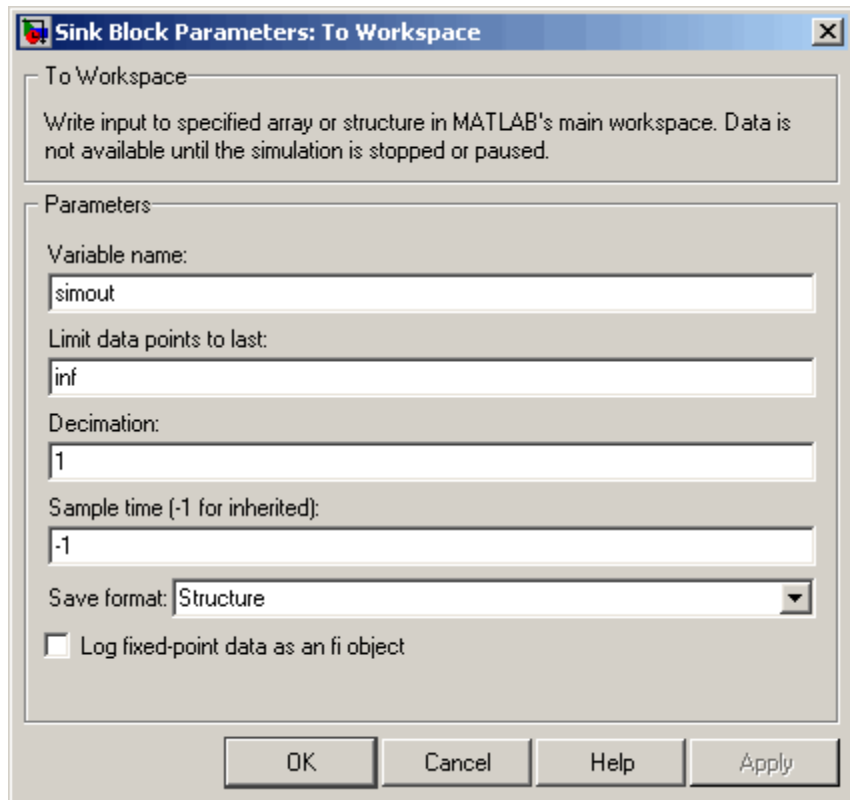

### Variable name

The name of the array that holds the data.

### Limit data points to last

The maximum number of input samples to be saved. The default is inf samples.

### Decimation

A decimation factor. The default is 1.

# To Workspace

---

## **Sample time**

The sample time at which to collect points. See “Specifying Sample Time” in the online documentation for more information.

## **Save format**

Format in which to save simulation output to the workspace. The default is structure.

## **Log fixed-point data as a fi object**

Select to log fixed-point data to the MATLAB workspace as a Simulink Fixed-Point `fi` object. Otherwise, fixed-point data is logged to the workspace as double.

## **Characteristics**

Sample Time	Specified in the <b>Sample time</b> parameter
Dimensionalized	Yes
Multidimensionalized	Yes

**Purpose** Model linear system by transfer function

**Library** Continuous

**Description**

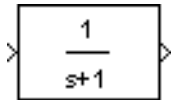

The Transfer Fcn block models a linear system by a transfer function of the Laplace-domain variable  $s$ . The block can model both single-input single-output (SISO) and single-input multiple output (SIMO) systems.

This block assumes that the transfer function has the following form

$$H(s) = \frac{y(s)}{u(s)} = \frac{num(s)}{den(s)} = \frac{num(1)s^{nn-1} + num(2)s^{nn-2} + \dots + num(nn)}{den(1)s^{nd-1} + den(2)s^{nd-2} + \dots + den(nd)}$$

where  $u$  and  $y$  are the system's input and outputs, respectively,  $nn$  and  $nd$  are the number of numerator and denominator coefficients, respectively.  $num$  and  $den$  contain the coefficients of the numerator and denominator in descending powers of  $s$ . The order of the denominator must be greater than or equal to the order of the numerator. This block also assumes that the transfer functions for the outputs of a multiple output system have the same denominator and that the numerators of the transfer functions have the same order.

To model a single-output system, enter a vector containing the system transfer function's numeric coefficients in the **Numerator coefficient** field in the block's parameter dialog box. Enter a vector containing the transfer function's denominator coefficients in the **Denominator coefficient** field. In this case, the input and output of the block are scalar time-domain signals.

To model a multiple-output system, enter a matrix in the **Numerator coefficient** field where each row of the matrix contains the numerator coefficients of a transfer function that determines one of the block's outputs. Enter a vector containing the denominator coefficients common to the system's transfer functions in the **Denominator coefficient** field. In this case, the block's input is a scalar and the block's output is a vector each of whose elements is an output of the system modeled by the block.

# Transfer Fcn

---

Initial conditions are preset to zero. If you need to specify initial conditions, convert to state-space form using `tf2ss` and use the State-Space block. The `tf2ss` utility provides the A, B, C, and D matrices for the system. For more information, type `help tf2ss` or consult the *Control System Toolbox documentation*.

## Transfer Fcn Display

The numerator and denominator are displayed on the Transfer Fcn block depending on how they are specified:

- If each is specified as an expression, a vector, or a variable enclosed in parentheses, the icon shows the transfer function with the specified coefficients and powers of  $s$ . If you specify a variable in parentheses, the variable is evaluated. For example, if you specify **Numerator** as `[3,2,1]` and **Denominator** as `(den)` where `den` is `[7,5,3,1]`, the block looks like this:

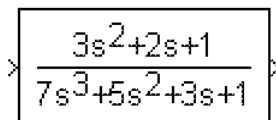
$$\frac{3s^2 + 2s + 1}{7s^3 + 5s^2 + 3s + 1}$$

- If each is specified as a variable, the block shows the variable name followed by  $(s)$ . For example, if you specify **Numerator** as `num` and **Denominator** as `den`, the block looks like this:

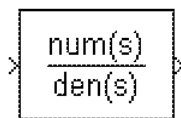
$$\frac{\text{num}(s)}{\text{den}(s)}$$

## Specifying the Absolute Tolerance for the Block's States

By default Simulink uses the absolute tolerance value specified in the **Configuration Parameters** dialog box (see “Absolute tolerance”) to solve the states of the Transfer Fcn block. If this value does not provide sufficient error control, specify a more appropriate value in the **Absolute tolerance** field of the Transfer Fcn block's dialog box. The value that you specify is used to solve all the block's states.

## Data Type Support

The Transfer Fcn block accepts and outputs signals of type double.

## Parameters and Dialog Box

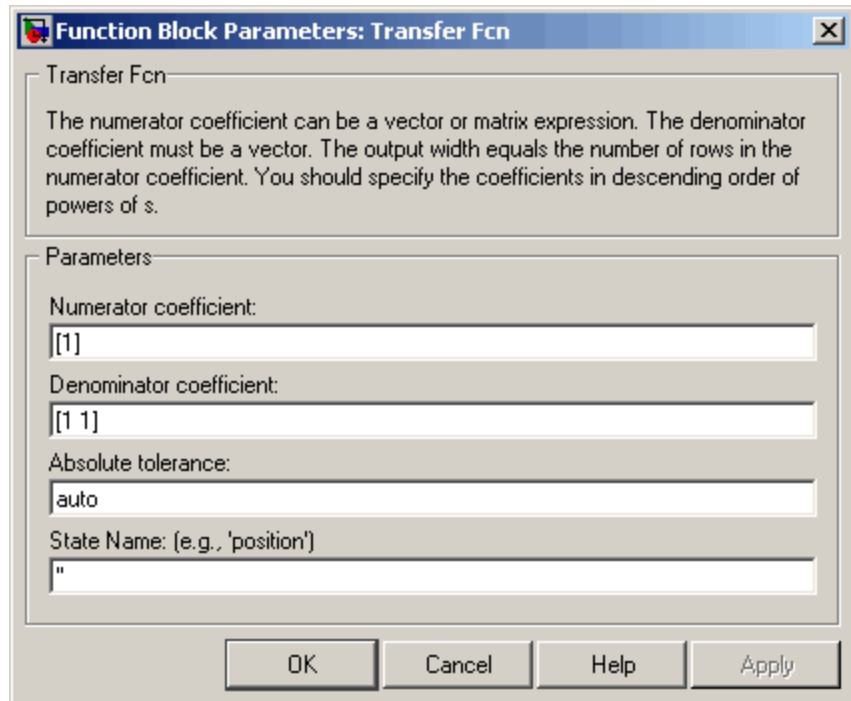

### Numerator coefficient

The row vector of numerator coefficients. A matrix with multiple rows can be specified to generate multiple output. The default is [1].

### Denominator coefficient

The row vector of denominator coefficients. The default is [1 1].

### Absolute tolerance

Absolute tolerance used to solve the block's states. You can enter auto or a numeric value. If you enter auto, Simulink determines

# Transfer Fcn

---

the absolute tolerance (see “Specifying Variable-Step Solver Error Tolerances”). If you enter a numeric value, Simulink uses the specified value to solve the block’s states. Note that a numeric value overrides the setting for the absolute tolerance in the **Configuration Parameters** dialog box.

## State Name

Use this to assign a unique name to each state. The state names apply only to the selected block. If left blank, no name is assigned.

To assign a name to a single state, enter the name between quotes, for example, 'velocity'.

To assign names to multiple states, enter a comma-delimited list surrounded by braces. For example, {'a', 'b', 'c'}. Each name must be unique.

The number of states must be evenly divided by the number of state names. There can be fewer names than the number of states, but there cannot be more names than states.

For example, you can specify two names in a system with four states. Simulink will assign the first name to the first two states and the second name to the last two.

To assign state names with a variable that has been defined in the MATLAB workspace, enter the variable without quotes. A variable can be a string, cell, or structure.

## Characteristics

Direct Feedthrough	Only if the lengths of the <b>Numerator</b> and <b>Denominator</b> parameters are equal
Sample Time	Continuous
Scalar Expansion	No

States	Length of <b>Denominator</b> -1
Dimensionalized	Yes, in the sense that the block expands scalar input into vector output when the transfer function numerator is a matrix. See the preceding block description.
Zero Crossing	No

# Transfer Fcn Direct Form II

---

**Purpose** Implement Direct Form II realization of transfer function

**Library** Additional Math & Discrete / Additional Discrete

## Description

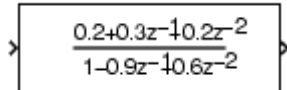
$$\frac{0.2+0.3z^{-1}+0.2z^{-2}}{1-0.9z^{-1}-0.6z^{-2}}$$

The Transfer Fcn Direct Form II block implements a Direct Form II realization of the transfer function specified by the **Numerator coefficients** and the **Denominator coefficients excluding lead** parameters. The block only supports single input-single output transfer functions.

The block automatically selects the data types and scalings of the output, the coefficients, and any temporary variables.

## Data Type Support

The Transfer Fcn Direct Form II block accepts signals of any data type supported by Simulink, including fixed-point data types.



## Parameters and Dialog Box

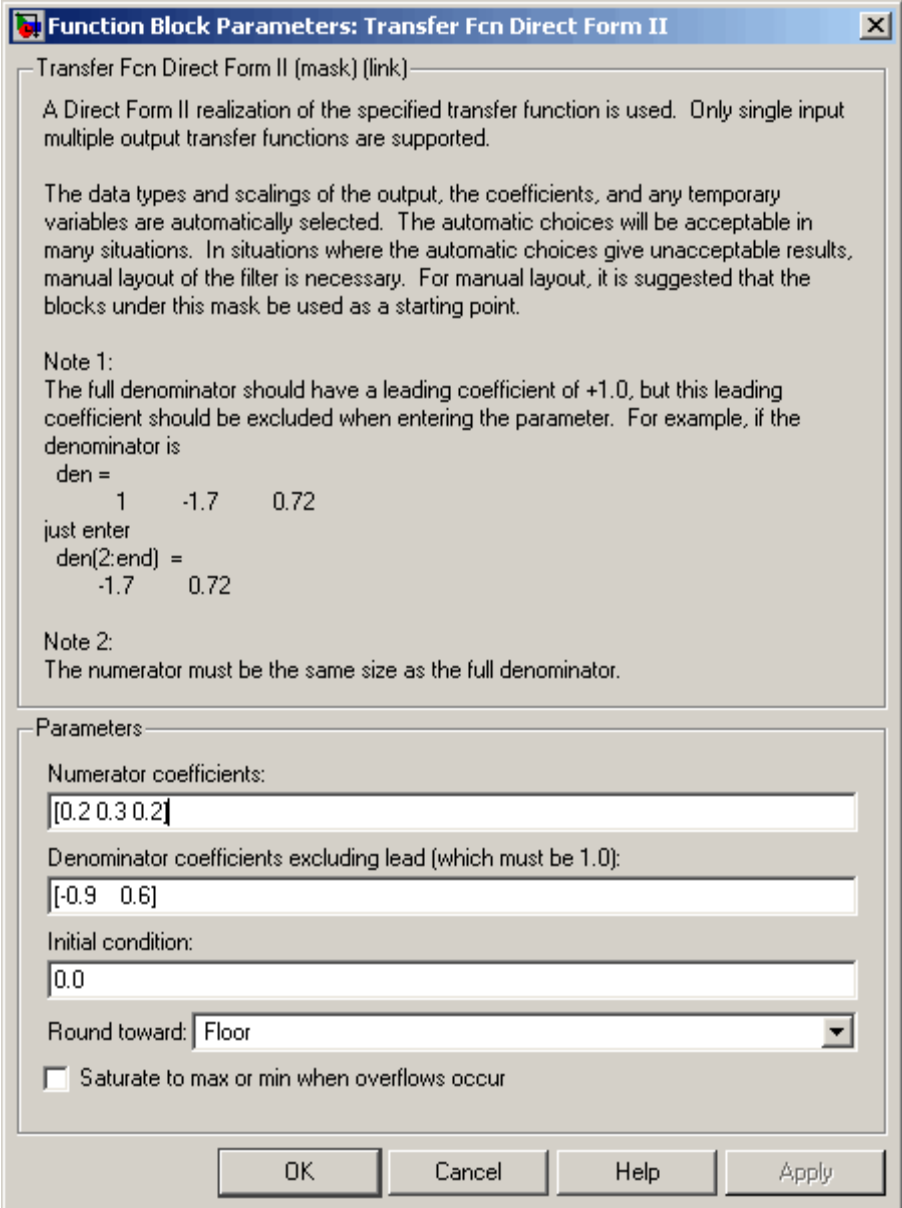

Function Block Parameters: Transfer Fcn Direct Form II

Transfer Fcn Direct Form II (mask) (link)

A Direct Form II realization of the specified transfer function is used. Only single input multiple output transfer functions are supported.

The data types and scalings of the output, the coefficients, and any temporary variables are automatically selected. The automatic choices will be acceptable in many situations. In situations where the automatic choices give unacceptable results, manual layout of the filter is necessary. For manual layout, it is suggested that the blocks under this mask be used as a starting point.

Note 1:  
The full denominator should have a leading coefficient of +1.0, but this leading coefficient should be excluded when entering the parameter. For example, if the denominator is

$$\text{den} = \begin{matrix} & 1 & -1.7 & 0.72 \end{matrix}$$

just enter

$$\text{den}(2:\text{end}) = \begin{matrix} -1.7 & 0.72 \end{matrix}$$

Note 2:  
The numerator must be the same size as the full denominator.

Parameters

Numerator coefficients:  
[0.2 0.3 0.2]

Denominator coefficients excluding lead (which must be 1.0):  
[-0.9 0.6]

Initial condition:  
0.0

Round toward: Floor

Saturate to max or min when overflows occur

OK Cancel Help Apply

# Transfer Fcn Direct Form II

---

## **Numerator coefficients**

Specify the numerator coefficients.

## **Denominator coefficients excluding lead**

Specify the denominator coefficients, excluding the leading coefficient, which must be 1.0.

## **Initial condition**

Set the initial condition.

## **Round toward**

Rounding mode for the fixed-point output.

## **Saturate to max or min when overflows occur**

If selected, fixed-point overflows saturate.

## **Characteristics**

Direct Feedthrough	Yes
Scalar Expansion	Yes, of initial conditions

## **See Also**

Transfer Fcn Direct Form II Time Varying

# Transfer Fcn Direct Form II Time Varying

**Purpose** Implement time varying Direct Form II realization of transfer function

**Library** Additional Math & Discrete / Additional Discrete

## Description

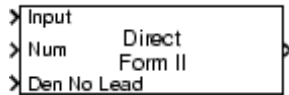

The Transfer Fcn Direct Form II Time Varying block implements a Direct Form II realization of the specified transfer function. The block only supports single input-single output transfer functions.

The signal entering the input port labeled Den No Lead contains the denominator coefficients of the transfer function. The full denominator should have a leading coefficient of one, however it should be excluded from the input signal. For example, a denominator of [1 -1.7 0.72] would be represented by a signal with the value [-1.7 0.72]. The signal entering the input port labeled Num contains the numerator coefficients. The data types of the numerator and denominator coefficients can be different, however, the length of the numerator vector and the full denominator vector must be the same. Pad the numerator vector with zeros, if needed.

The block automatically selects the data types and scalings of the output, the coefficients, and any temporary variables.

## Data Type Support

The Transfer Fcn Direct Form II Time Varying block accepts signals of any data type supported by Simulink, including fixed-point data types.

# Transfer Fcn Direct Form II Time Varying

## Parameters and Dialog Box

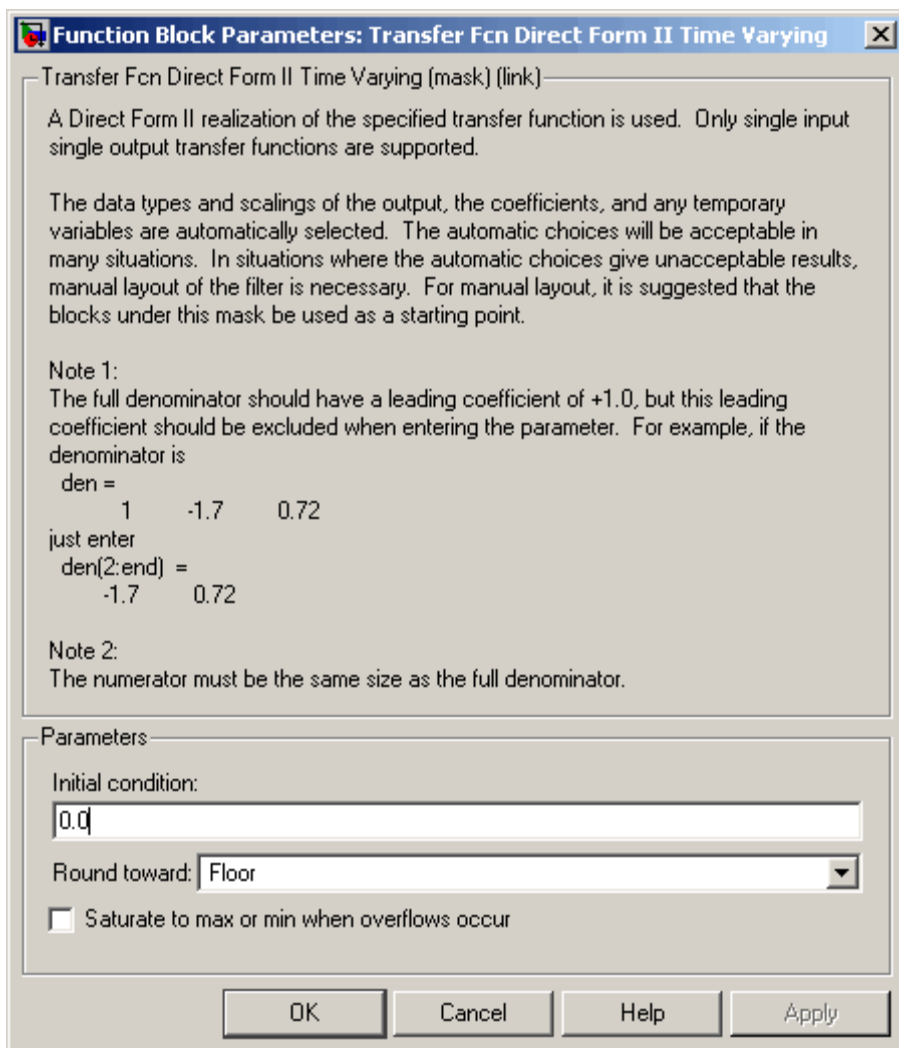

### Initial condition

Set the initial condition.

# Transfer Fcn Direct Form II Time Varying

---

## Round toward

Rounding mode for the fixed-point output.

## Saturate to max or min when overflows occur

If selected, fixed-point overflows saturate.

## Characteristics

Direct Feedthrough	Yes
Scalar Expansion	Yes, of initial conditions

## See Also

Transfer Fcn Direct Form II

# Transfer Fcn First Order

**Purpose** Implement discrete-time first order transfer function

**Library** Discrete

**Description** The Transfer Fcn First Order block implements a discrete-time first order transfer function of the input. The transfer function has a unity DC gain.

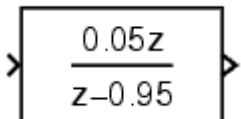

**Data Type Support** The Transfer Fcn First Order block accepts signals of any data type supported by Simulink, including fixed-point data types.

## Parameters and Dialog Box

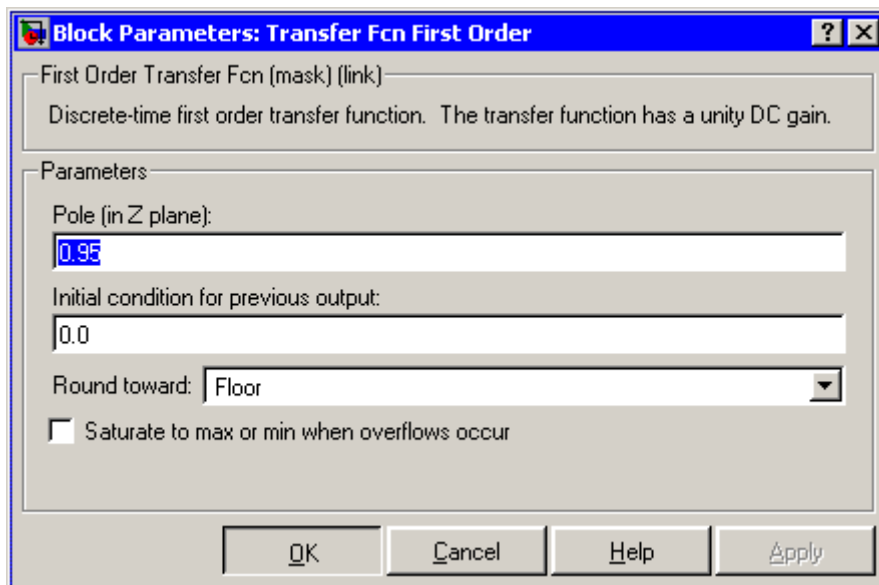

**Pole (in Z plane)**  
Set the pole.

**Initial condition for previous output**

Set the initial condition for the previous output.

**Round toward**

Rounding mode for the fixed-point output.

**Saturate to max or min when overflows occur**

If selected, fixed-point overflows saturate.

**Characteristics**

Direct Feedthrough	Yes
Scalar Expansion	Yes, of initial conditions

# Transfer Fcn Lead or Lag

---

**Purpose** Implement discrete-time lead or lag compensator

**Library** Discrete

**Description** The Transfer Fcn Lead or Lag block implements a discrete-time lead or lag compensator of the input. The instantaneous gain of the compensator is one, and the DC gain is equal to  $(1-z)/(1-p)$ , where  $z$  is the zero and  $p$  is the pole of the compensator.

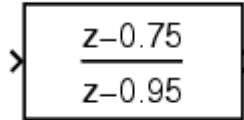

The block implements a lead compensator when  $0 < z < p < 1$ , and implements a lag compensator when  $0 < p < z < 1$ .

**Data Type Support** The Transfer Fcn Lead or Lag block accepts signals of any data type supported by Simulink, including fixed-point data types.



## Parameters and Dialog Box

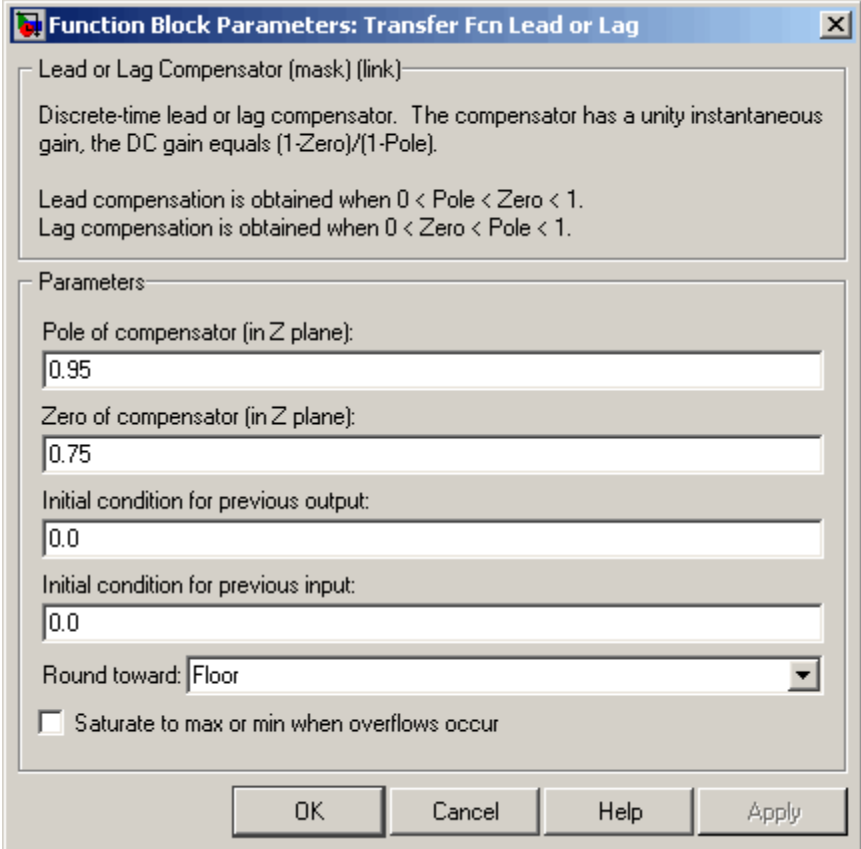

**Function Block Parameters: Transfer Fcn Lead or Lag**

Lead or Lag Compensator (mask) (link)

Discrete-time lead or lag compensator. The compensator has a unity instantaneous gain, the DC gain equals  $(1-\text{Zero})/(1-\text{Pole})$ .

Lead compensation is obtained when  $0 < \text{Pole} < \text{Zero} < 1$ .  
Lag compensation is obtained when  $0 < \text{Zero} < \text{Pole} < 1$ .

Parameters

Pole of compensator (in Z plane):  
0.95

Zero of compensator (in Z plane):  
0.75

Initial condition for previous output:  
0.0

Initial condition for previous input:  
0.0

Round toward: Floor

Saturate to max or min when overflows occur

OK Cancel Help Apply

### **Pole of compensator (in Z plane)**

Set the pole.

### **Zero of compensator (in Z plane)**

Set the zero.

### **Initial condition for previous output**

Set the initial condition for the previous output.

# Transfer Fcn Lead or Lag

---

**Initial condition for previous input**

Set the initial condition for the previous input.

**Round toward**

Rounding mode for the fixed-point output.

**Saturate to max or min when overflows occur**

If selected, fixed-point overflows saturate.

**Characteristics**

Direct Feedthrough	Yes
Scalar Expansion	Yes, of initial conditions

**Purpose** Implement discrete-time transfer function that has real zero and no pole

**Library** Discrete

**Description** The Transfer Fcn Real Zero block implements a discrete-time transfer function that has a real zero and effectively has no pole.

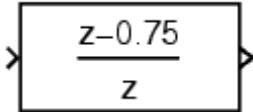

**Data Type Support** The Transfer Fcn Real Zero block accepts signals of any data type supported by Simulink, including fixed-point data types.

## Parameters and Dialog Box

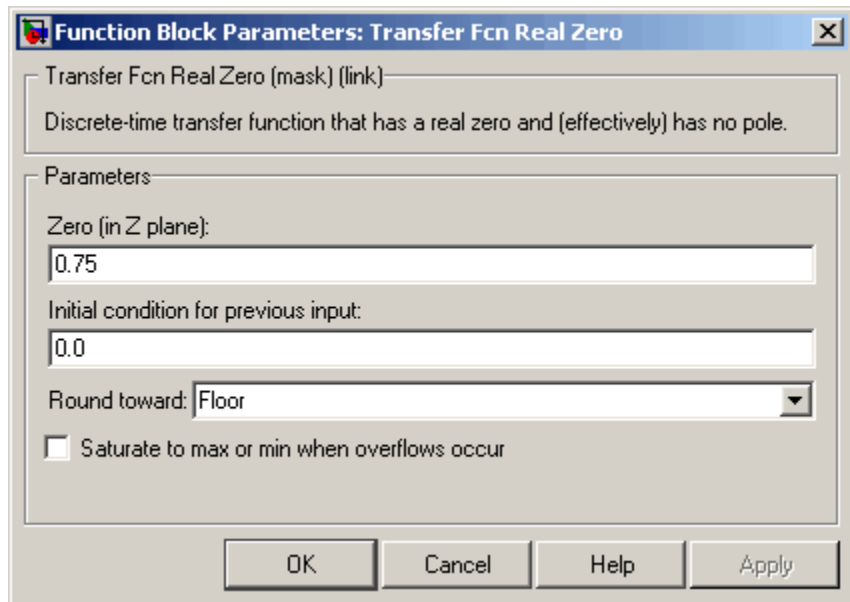

### Zero (in Z plane)

Set the zero.

# Transfer Fcn Real Zero

---

**Initial condition for previous input**

Set the initial condition for the previous input.

**Round toward**

Rounding mode for the fixed-point output.

**Saturate to max or min when overflows occur**

If selected, fixed-point overflows saturate.

**Characteristics**

Direct Feedthrough	Yes
Scalar Expansion	Yes, of initial conditions

## Purpose

Delay input by given amount of time

## Library

Continuous

## Description



The Transport Delay block delays the input by a specified amount of time. It can be used to simulate a time delay.

At the start of the simulation, the block outputs the **Initial output** parameter until the simulation time exceeds the **Time delay** parameter, when the block begins generating the delayed input. The **Time delay** parameter must be nonnegative.

The block stores input points and simulation times during a simulation in a buffer whose initial size is defined by the **Initial buffer size** parameter. If the number of points exceeds the buffer size, the block allocates additional memory and Simulink displays a message after the simulation that indicates the total buffer size needed. Because allocating memory slows down the simulation, define this parameter value carefully if simulation speed is an issue. For long time delays, this block might use a large amount of memory, particularly for dimensionalized input.

When output is required at a time that does not correspond to the times of the stored input values, the block interpolates linearly between points. When the delay is smaller than the step size, the block extrapolates from the last output point, which can produce inaccurate results. Because the block does not have direct feedthrough, it cannot use the current input to calculate its output value. To illustrate this point, consider a fixed-step simulation with a step size of 1 and the current time at  $t = 5$ . If the delay is 0.5, the block needs to generate a point at  $t = 4.5$ . Because the most recent stored time value is at  $t = 4$ , the block performs forward extrapolation.

The Transport Delay block does not interpolate discrete signals. Instead, it returns the discrete value at the required time.

This block differs from the Unit Delay block, which delays and holds the output on sample hits only.

# Transport Delay

---

Using `linmod` to linearize a model that contains a Transport Delay block can be troublesome. For more information about ways to avoid the problem, see “Linearizing Models” in the “Analyzing Simulation Results” chapter of the Using Simulink documentation.

## Data Type Support

The Transport Delay block accepts and outputs real signals of type `double`.

## Parameters and Dialog Box

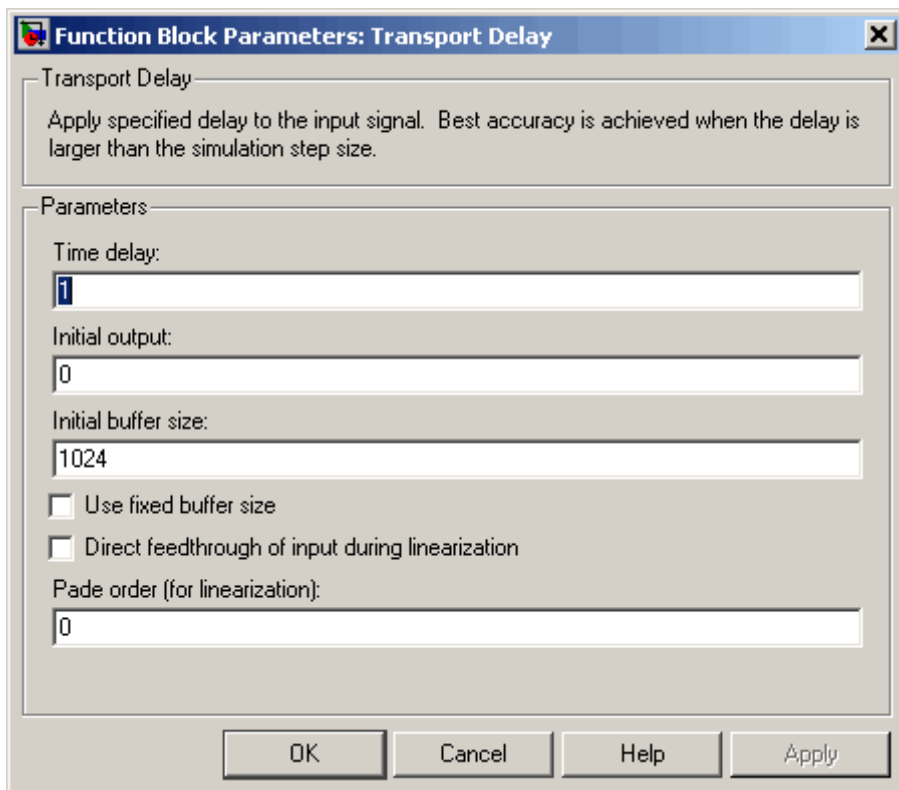

**Time delay**

The amount of simulation time that the input signal is delayed before being propagated to the output. The value must be nonnegative.

**Initial output**

Specifies the output of the block at simulation time 0.

**Initial buffer size**

The initial memory allocation for the number of points to store.

**Use fixed buffer size**

Specifies use of a fixed-size buffer to save input data from previous time steps. The **Initial buffer size** parameter specifies the buffer's size. If the buffer is full, new data replaces data already in the buffer. Simulink uses linear extrapolation to estimate the output value if it is not in the buffer. This option can save memory if the input data is linear. If the input is not linear, this option may yield inaccurate results.

---

**Note** ERT or GRT code generation uses a fixed-size buffer even if you do not select this check box.

---

**Direct feedthrough of input during linearization**

Causes the block to output its input during linearization and trim. This sets the block's mode to direct feedthrough.

Enabling this check box can cause a change in the ordering of states in the model when using the functions `linmod`, `dlinmod`, or `trim`. To extract this new state ordering, use the following commands.

First compile the model using the following command, where `model` is the name of the Simulink model.

```
[sizes, x0, x_str] = model([],[],[],'lincompile');
```

# Transport Delay

---

Next, terminate the compilation with the following command.

```
model([],[],[], 'term');
```

The output argument, `x_str`, which is a cell array of the states in the Simulink model, contains the new state ordering. When passing a vector of states as input to the `linmod`, `dlinmod`, or `trim` functions, the state vector must use this new state ordering.

### **Pade order (for linearization)**

The order of the Pade approximation for linearization routines. The default value is 0, which results in a unity gain with no dynamic states. Setting the order to a positive integer `n` adds `n` states to your model, but results in a more accurate linear model of the transport delay.

### **Characteristics**

Direct Feedthrough	No
Sample Time	Continuous
Scalar Expansion	Yes, of input and all parameters except <b>Initial buffer size</b>
Dimensionalized	Yes
Zero Crossing	No



**Purpose** Add trigger port to subsystem or function-call model

**Library** Ports & Subsystems

## Description



Adding a Trigger block to a subsystem or a model allows its execution to be triggered by an external signal. You can configure the Trigger block to enable a change in the value of the external signal (described below) to trigger execution of a subsystem once on each integration step when the value of the signal that passes through the trigger port changes in a specifiable way (see “Triggered Subsystems”). You can also configure the Trigger block to accept a function-call trigger. This allows a Function-Call Generator block or S-function to trigger execution of a subsystem or model multiple times during a time step. A subsystem or model can contain only one Trigger block. For more information, see “Defining Function-Call Models” and “Function-Call Subsystems”.

The **Trigger type** parameter allows you to choose the type of event that triggers execution of the subsystem:

- **rising** triggers execution of the subsystem when the control signal rises from a negative or zero value to a positive value (or zero if the initial value is negative).
- **falling** triggers execution of the subsystem when the control signal falls from a positive or a zero value to a negative value (or zero if the initial value is positive).
- **either** triggers execution of the subsystem when the signal is either rising or falling.
- **function-call** allows a Function-Call Generator or S-function to control execution of the subsystem or model.

---

**Note** The **Trigger type** must be function-call for Trigger ports at the root-level of a model. In other words, only function-call signals can trigger execution of a model.

---

# Trigger

---

You can output the trigger signal by selecting the **Show output port** check box. Selecting this option allows the system to determine what caused the trigger. The width of the signal is the width of the triggering signal. The signal value is

- 1 for a signal that causes a rising trigger
- -1 for a signal that causes a falling trigger
- 2 for a function-call trigger
- 0 otherwise

## Data Type Support

The Trigger block accepts signals of any data type supported by Simulink, including fixed-point data types.

For a discussion on the data types supported by Simulink, see “Data Types Supported by Simulink” in the Simulink documentation.

## Parameters and Dialog Box

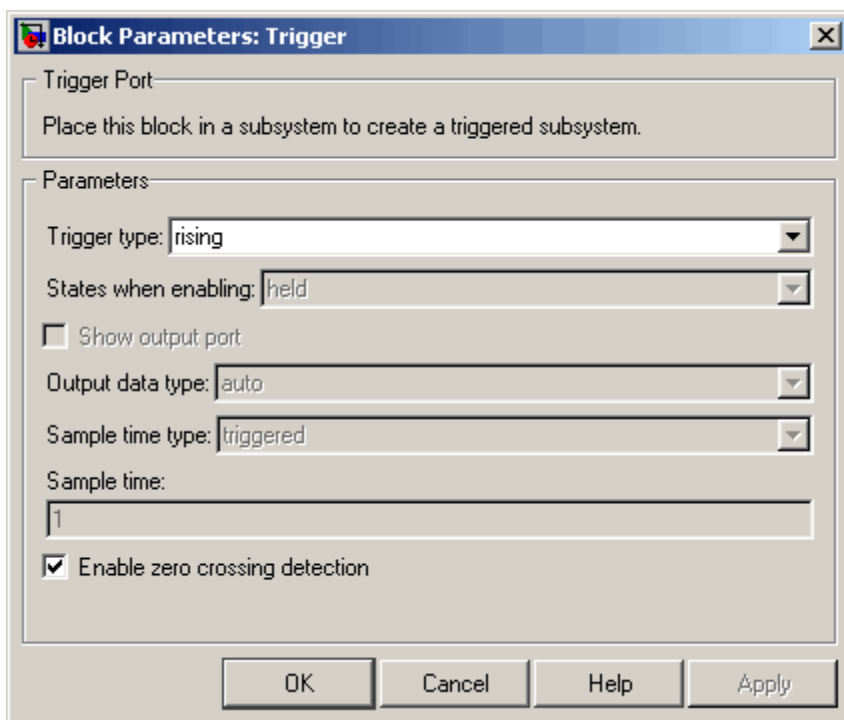

### Trigger type

The type of event that triggers execution of the subsystem.

### States when enabling

This option is enabled only if you select function-call as the block's trigger type and the setting applies only if the function-call subsystem is explicitly enabled and disabled. For example:

- The function-call subsystem resides inside of an enabled subsystem. In this case, the function-call subsystem is enabled and disabled along with the parent subsystem.
- The function-call initiator that controls the function-call subsystem resides in an enabled subsystem. In this case, the

function-call subsystem is enabled and disabled along with the enabled subsystem containing the function-call initiator.

- The function-call initiator is a Stateflow event that is bound to a particular state. See “Using Bind Actions to Control Function-Call Subsystems” in the Stateflow documentation.
- The function-call initiator is an S-function that explicitly enables and disables the function-call subsystem. See `ssEnableSystemWithTid` for an example.

Selecting `held` (the default) causes Simulink to leave the states at their current values.

Selecting `reset` for this option causes Simulink to reset the states.

Selecting `inherit` causes the trigger’s `held/reset` setting to be the same as that of the function-call initiator’s parent subsystem, for example, an enabled subsystem, or the model’s root system if the function-call initiator is at the model’s root level. If the parent of the initiator is the model root, the inherited setting is `held`. If the trigger has multiple initiators and its **States when enabling** setting is `inherit`, the parents of all initiators must have the same `held/reset` setting, i.e., either all `held` or all `reset`.

### Show output port

If selected and this block is in a subsystem, Simulink displays the Trigger block output port and outputs the trigger signal.

---

**Note** This option is disabled for function-call Trigger blocks residing at the root-level of a model.

---

### Output data type

Specifies the data type (`double` or `int8`) of the trigger output. If you select `auto`, Simulink sets the data type to be the same as

that of the port to which the output is connected. If the port's data type is not double or int8, Simulink signals an error.

---

**Note** The Trigger block ignores the **Data type override** setting of the Fixed-Point Tool.

---

### **Enable zero crossing detection**

Select to enable zero crossing detection. For more information, see “Zero-Crossing Detection” in the “How Simulink Works” chapter of the Using Simulink documentation.

### **Sample time type**

This parameter is active only when **Trigger type** is set to function-call. Its value may be triggered or periodic. Select periodic if the caller of the parent function-call subsystem, for example, a Stateflow chart, calls the subsystem once per time step when the subsystem is active (enabled). Otherwise, select triggered. See "Using Bind Actions to Control Function-Call Subsystems" in *Using Stateflow* and the "Function-Call Subsystems" section of *Writing S-functions* for more information.

### **Sample time**

This parameter is active only when the **Trigger type** is function-call and the **Sample time type** is periodic. Set this parameter to the sample time at which you expect the function-call subsystem that contains this block to be called. See “Specifying Sample Time” in the online documentation for information on how to the value of this parameter. Simulink displays an error if the actual rate at which the subsystem is called differs from the rate that this parameter specifies.

# Trigger

---

## Characteristics

Sample Time	Determined by the sample time parameter if the trigger type is function-call and the sample time type is periodic; otherwise, by the signal at the trigger port.
Dimensionalized	Yes
Zero Crossing	Yes, if enabled

## Purpose

Generate linear models in base workspace when triggered

## Library

Model-Wide Utilities

## Description

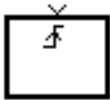

When triggered, this block calls `linmod` or `dlinmod` to create a linear model for the system at the current operating point. No trimming is performed. The linear model is stored in the base workspace as a structure, along with information about the operating point at which the snapshot was taken. Multiple snapshots are appended to form an array of structures.

The block sets the following model parameters to the indicated values:

- `BufferReuse` = 'off'
- `RTWInlineParameters` = 'on'
- `BlockReductionOpt` = 'off'

The name of the structure used to save the snapshots is the name of the model appended by `_Trigger_Based_Linearization`, for example, `vdp_Trigger_Based_Linearization`. The structure has the following fields:

Field	Description
<code>a</code>	The A matrix of the linearization
<code>b</code>	The B matrix of the linearization
<code>c</code>	The C matrix of the linearization
<code>d</code>	The D matrix of the linearization
<code>StateName</code>	Names of the model's states
<code>OutputName</code>	Names of the model's output ports
<code>InputName</code>	Names of the model's input ports

# Trigger-Based Linearization

---

Field	Description
OperPoint	A structure that specifies the operating point of the linearization. The structure specifies the value of the model's states (OperPoint.x) and inputs (OperPoint.u) at the operating point time (OperPoint.t).
Ts	The sample time of the linearization for a discrete linearization

Use the Time-Based Linearization block to generate linear models at predetermined times.

You can use state and simulation time logging to extract the model states at operating points. For example, suppose that you want to get the states of the vdp demo model when the signal x1 triggers the Trigger-Based Linearization block on a rising edge.

- 1 Open the model and drag an instance of this block from the Model-Wide Utilities library and drop the instance into the model.
- 2 Connect the block's trigger port to the signal labeled x1.
- 3 Open the model's **Configuration Parameters** dialog box.
- 4 Select the **Data Import/Export** pane.
- 5 Check **States** and **Time** on the **Save to Workspace** control panel
- 6 Select OK to confirm the selections and close the dialog box.
- 7 Simulate the model.

At the end of the simulation, the following variables appear in the MATLAB workspace: vdp\_Trigger\_Based\_Linearization, tout, and xout.

- 8 Get the index to the first operating point time by entering the following at the MATLAB command line:



```
ind1 = find(vdp_Trigger_Based_Linearization(1).OperPoint.t==tout);
```

- 9 Get the state vector at this operating point.

```
x1 = xout(ind1,:);
```

## Data Type Support

The trigger port accepts signals of any data type supported by Simulink.

## Parameters and Dialog Box

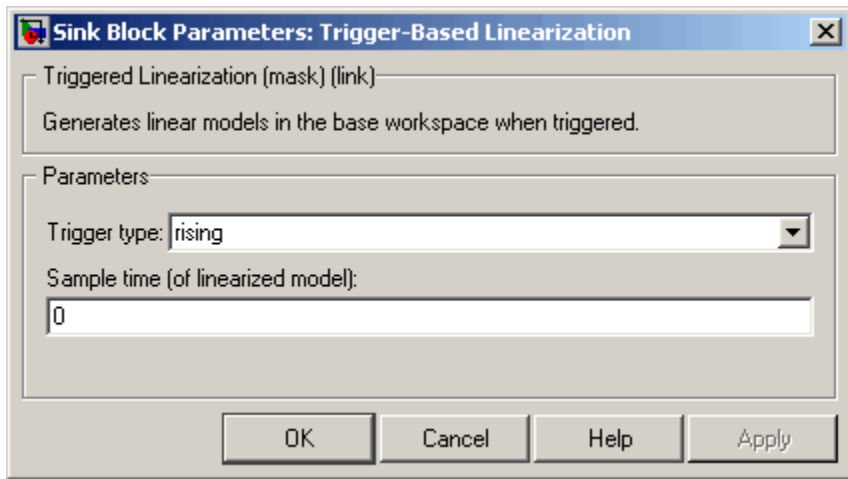

### Trigger type

Type of event on the trigger input signal that triggers generation of a linear model. See the **Trigger type** parameter of the Trigger block for an explanation of the various trigger types that you can select.

### Sample time (of linearized model)

Specify a sample time to create a discrete-time linearization of the model (see “Discrete-Time System Linearization” on page 4-99).

# Trigger-Based Linearization

---

<b>Characteristics</b>	Sample Time	Specified in the <b>Sample time</b> parameter
	Dimensionalized	No

**See Also**      Time-Based Linearization

**Purpose** Represent subsystem whose execution is triggered by external input

**Library** Ports & Subsystems

**Description** This block is a Subsystem block that is preconfigured to serve as the starting point for creating a triggered subsystem (see “Triggered Subsystems”).

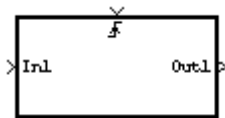

# Trigonometric Function

---

**Purpose** Perform trigonometric function

**Library** Math Operations

**Description** The Trigonometric Function block performs numerous common trigonometric functions.

You can select one of these functions from the **Function** list: `sin`, `cos`, `tan`, `asin`, `acos`, `atan`, `atan2`, `sinh`, `cosh`, `tanh`, `asinh`, `acosh`, and `atanh`. The block output is the result of the operation of the function on one or more inputs.

The name of the function appears on the block. If you select the `atan2` function, the block displays two inputs. The first input is the  $y$ -axis or complex part of the function argument. The second input is the  $x$ -axis or real part of the function argument. (See “Changing the Orientation of a Block” in *Using Simulink* for a description of the port order for various block orientations.)

Use the Trigonometric Function block instead of the Fcn block when you want dimensionalized output, because the Fcn block can produce only scalar output.

**Data Type Support** The Trigonometric Function block accepts and outputs real or complex signals of type double.

## Parameters and Dialog Box

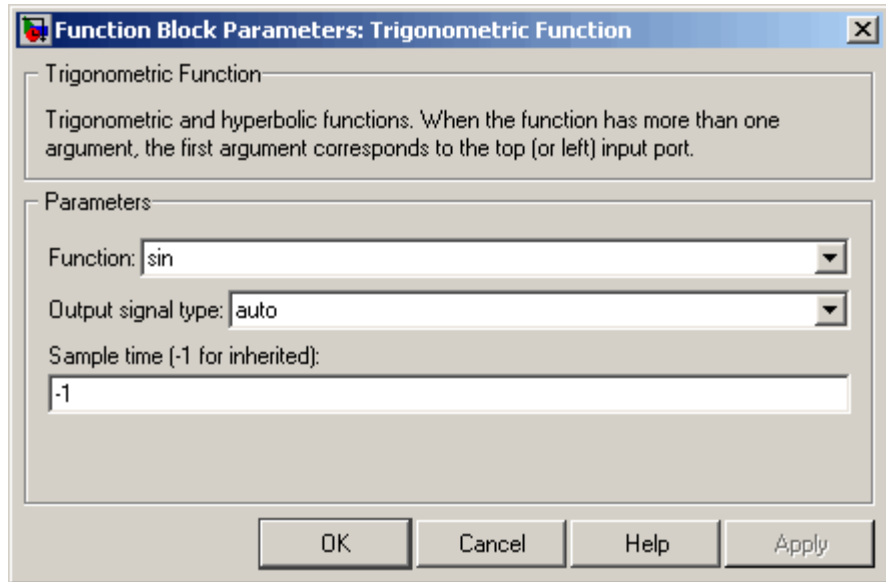

### Function

The trigonometric function.

### Output signal type

Type of signal (complex or real) to output.

---

**Note** The Trigonometric Function block cannot output complex signals in the code that Real-Time Workshop generates.

---

### Sample time (-1 for inherited)

Specify the time interval between samples. To inherit the sample time, set this parameter to -1. See “Specifying Sample Time” in *Using Simulink* for more information.

# Trigonometric Function

---

<b>Characteristics</b>	Direct Feedthrough	Yes
	Sample Time	Inherited from driving block
	Scalar Expansion	Yes, of the input when the function requires two inputs
	Dimensionalized	Yes
	Multidimensionalized	Yes
	Zero Crossing	No

**Purpose** Negate input

**Library** Math Operations

**Description** The Unary Minus block negates the input. The block accepts only signed data types.

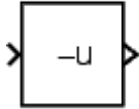

For signed data types, you cannot accurately negate the most negative value since the result is not representable by the data type. In this case, the behavior of the block is controlled by the **Saturate to max or min when overflows occur** check box. If selected, the most negative value of the data type wraps to the most positive value. If not selected, the operation has no effect. If an overflow occurs, then a warning is returned to the MATLAB command line.

For example, suppose the block input is an 8-bit signed integer. The range of this data type is from -128 to 127, and the negation of -128 is not representable. If you select the **Saturate to max or min when overflows occur** check box, then the negation of -128 is 127. If it is not selected, then the negation of -128 remains at -128.

**Data Type Support** The Unary Minus block accepts signals of any data type supported by Simulink except unsigned integers, including fixed-point data types.

# Unary Minus

## Parameters and Dialog Box

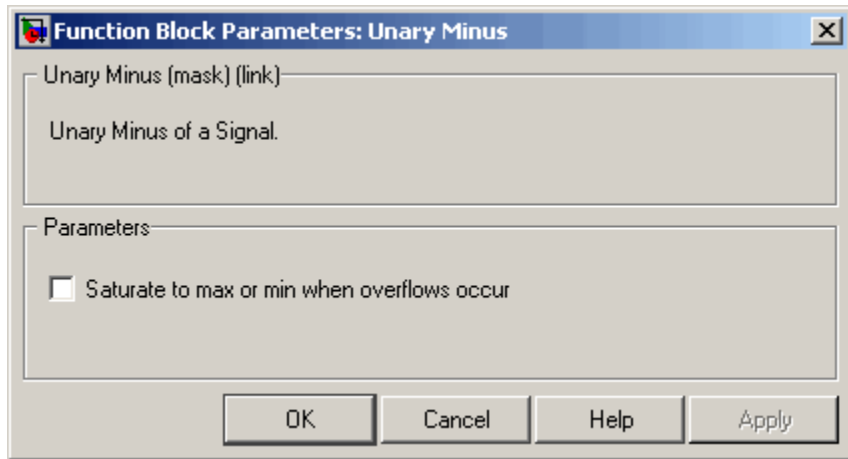

### Saturate to max or min when overflows occur

If selected, fixed-point overflows saturate.

## Characteristics

Direct Feedthrough	No
Scalar Expansion	Yes, of input or initial conditions
Multidimensionalized	Yes



## Purpose

Generate uniformly distributed random numbers

## Library

Sources

## Description



The Uniform Random Number block generates uniformly distributed random numbers over a specifiable interval with a specifiable starting seed. The seed is reset each time a simulation starts. The generated sequence is repeatable and can be produced by any Uniform Random Number block with the same seed and parameters. To generate normally distributed random numbers, use the Random Number block.

Avoid integrating a random signal, because solvers are meant to integrate relatively smooth signals. Instead, use the Band-Limited White Noise block.

The block's numeric parameters must be of the same dimensions after scalar expansion. If the **Interpret vector parameters as 1-D** option is off, the block outputs a signal of the same dimensions and dimensionality as the parameters. If the **Interpret vector parameters as 1-D** option is on and the numeric parameters are row or column vectors (i.e., single row or column 2-D arrays), the block outputs a vector (1-D array) signal.

## Data Type Support

The Uniform Random Number block outputs a real signal of type double.

# Uniform Random Number

---

## Parameters and Dialog Box

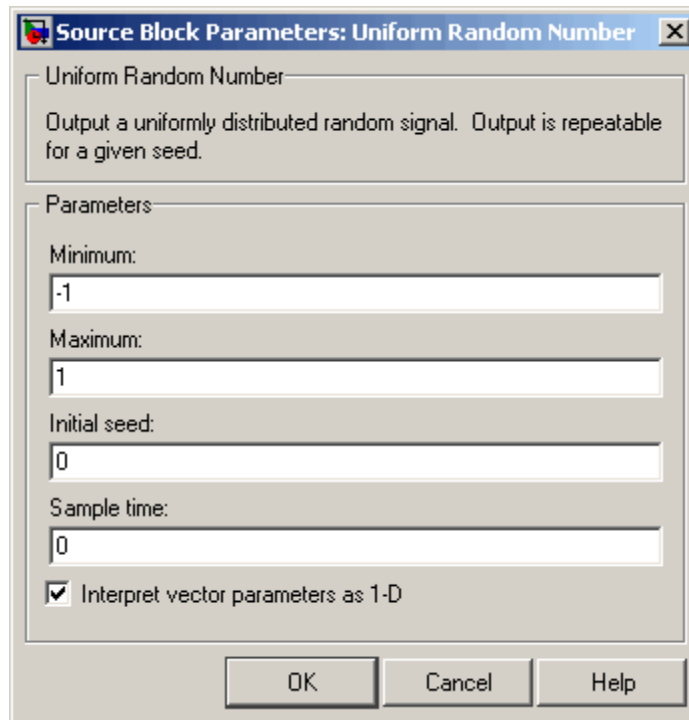

Opening this dialog box causes a running simulation to pause. See “Changing Source Block Parameters During Simulation” in the online Simulink documentation for details.

### **Minimum**

The minimum of the interval. The default is -1.

### **Maximum**

The maximum of the interval. The default is 1.

### **Initial seed**

The starting seed for the random number generator. The default is 0.

## Sample time

The sample period. The default is 0. See “Specifying Sample Time” in the online documentation for more information.

## Interpret vector parameters as 1-D

If selected, column or row matrix values for the Uniform Random Number block’s numeric parameters result in a vector output signal; otherwise, the block outputs a signal of the same dimensionality as the parameters. If this option is not selected, the block always outputs a signal of the same dimensionality as the block’s numeric parameters. See “Determining the Output Dimensions of Source Blocks” in the “Working with Signals” chapter of the Using Simulink documentation.

## Characteristics

Sample Time	Specified in the <b>Sample time</b> parameter
Scalar Expansion	No
Dimensionalized	Yes
Multidimensionalized	Yes
Zero Crossing	No

# Unit Delay

---

**Purpose** Delay signal one sample period

**Library** Discrete

## Description

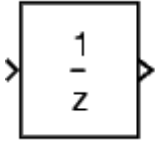

The Unit Delay block delays its input by the specified sample period. This block is equivalent to the  $z^{-1}$  discrete-time operator. The block accepts one input and generates one output, which can be either both scalar or both vector. If the input is a vector, all elements of the vector are delayed by the same sample period.

You specify the block output for the first sampling period with the **Initial conditions** parameter. Careful selection of this parameter can minimize unwanted output behavior. The time between samples is specified with the **Sample time** parameter. A setting of -1 means the sample time is inherited.

---

**Note** The Unit Delay block accepts continuous signals. When it has a continuous sample time, the block is equivalent to the Simulink Memory block.

---

The Unit Delay block provides a mechanism for discretizing one or more signals in time.

---

**Note** Do not use the Unit Delay block to create a slow-to-fast transition between blocks operating at different sample rates. Instead, use the Rate Transition block.

---

## Data Type Support

The Unit Delay block accepts real or complex signals of any data type supported by Simulink, including fixed-point data types. If the data type of the input signal is user-defined, the initial condition must be zero.

For a discussion on the data types supported by Simulink, see “Data Types Supported by Simulink” in the Simulink documentation.

## Parameters and Dialog Box

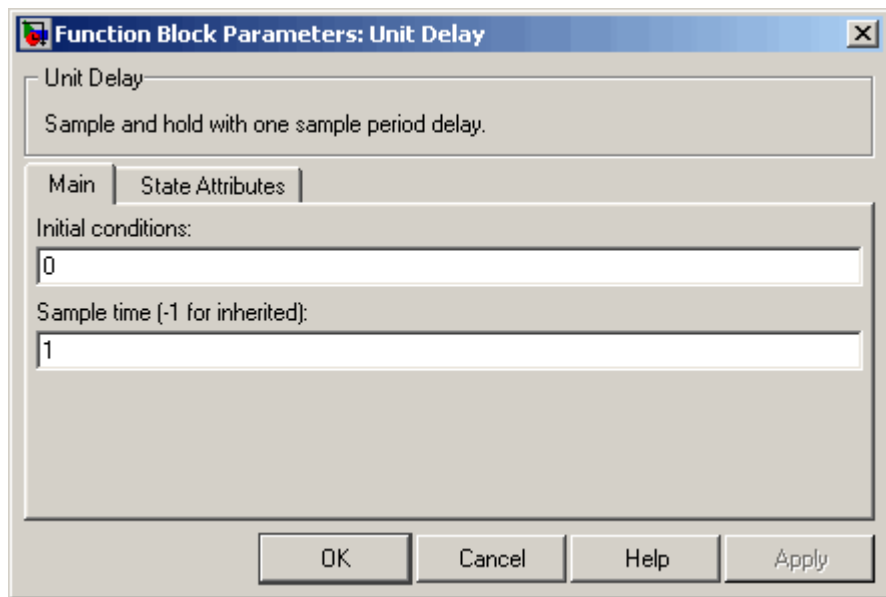

### Initial conditions

The output of the simulation for the first sampling period, during which the output of the Unit Delay block is otherwise undefined.

The **Initial conditions** parameter is converted from a double to the input data type offline using round-to-nearest and saturation.

### Sample time (-1 for inherited)

Specify the time interval between samples. To inherit the sample time, set this parameter to -1. See “Specifying Sample Time” in the online documentation for more information.

The **State Attributes** pane of this block pertains to code generation and has no effect on model simulation. See “Block State Storage and Interfacing” in the Real-Time Workshop documentation for more information.

# Unit Delay

---

## Bus Support

The Unit Delay block is a bus-capable block. The input can be a virtual or nonvirtual bus signal subject to the following restrictions:

- **Initial conditions** must be zero or a non-zero scalar.
- If **Initial conditions** is zero and a **State name** is specified, the input cannot be a virtual bus.
- If **Initial conditions** is a non-zero scalar, no **State name** can be specified.

## Characteristics

Bus-capable	Yes, with restrictions as noted above
Direct Feedthrough	No
Sample Time	Specified in the <b>Sample time</b> parameter
Scalar Expansion	Yes, of input or initial conditions
States	Yes--inherited from driving block for nonfixed-point data types.
Dimensionalized	Yes
Multidimensionalized	Yes
Zero Crossing	No

## See Also

Unit Delay Enabled, Unit Delay Enabled External IC, Unit Delay Enabled Resettable, Unit Delay Enabled Resettable External IC, Unit Delay External IC, Unit Delay Resettable, Unit Delay Resettable External IC, Unit Delay With Preview Enabled, Unit Delay With Preview Enabled Resettable, Unit Delay With Preview Enabled Resettable External RV, Unit Delay With Preview Resettable, Unit Delay With Preview Resettable External RV

## Purpose

Delay signal one sample period, if external enable signal is on

## Library

Additional Math & Discrete / Additional Discrete

## Description

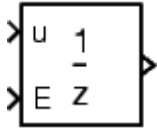

The Unit Delay Enabled block delays a signal by one sample period when the external enable signal E is on. While the enable is off, the block is disabled. It holds the current state at the same value and outputs that value. The enable signal is on when E is not 0, and off when E is 0.

You specify the block output for the first sampling period with the value of the **Initial condition** parameter.

The output data type is the same as the input u data type. The data type of the input u and the enable E can be any data type.

You input the sample time with the **Sample time** parameter. A setting of -1 means the **Sample time** is inherited.

## Data Type Support

The Unit Delay Enabled block accepts signals of any data type supported by Simulink, including fixed-point data types.

# Unit Delay Enabled

## Parameters and Dialog Box

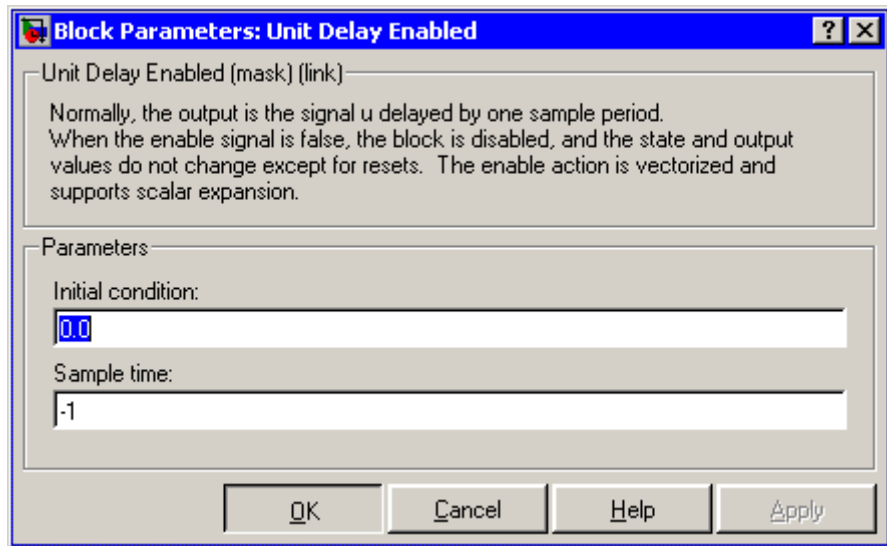

### Initial condition

Initial condition.

### Sample time

Specify the time interval between samples. To inherit the sample time, set this parameter to -1. See “Specifying Sample Time” in the online documentation for more information.

## Characteristics

Direct Feedthrough	No
Sample Time	Specified in the <b>Sample time</b> parameter
Scalar Expansion	Yes

## See Also

Unit Delay, Unit Delay Enabled External IC, Unit Delay Enabled Resettable, Unit Delay Enabled Resettable External IC, Unit Delay External IC, Unit Delay Resettable, Unit Delay Resettable External IC, Unit Delay With Preview Enabled, Unit Delay With Preview Enabled



Resettable, Unit Delay With Preview Enabled Resettable External  
RV, Unit Delay With Preview Resettable, Unit Delay With Preview  
Resettable External RV

# Unit Delay Enabled External IC

## Purpose

Delay signal one sample period, if external enable signal is on, with external initial condition

## Library

Additional Math & Discrete / Additional Discrete

## Description

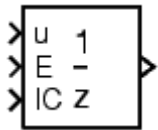

The Unit Delay Enabled External IC block delays a signal by one sample period when the enable signal E is on. While the enable is off, the block holds the current state at the same value and outputs that value. The enable E is on when E is not 0, and off when E is 0.

The initial condition of this block is given by the signal IC.

The input u and IC data types must be the same, and are any data type. The output data type is the same as u and IC. The enable E is any data type.

You specify the time between samples with the **Sample time** parameter. A setting of -1 means the **Sample time** is inherited.

## Data Type Support

The Unit Delay Enabled External IC block accepts signals of any data type supported by Simulink, including fixed-point data types.

## Parameters and Dialog Box

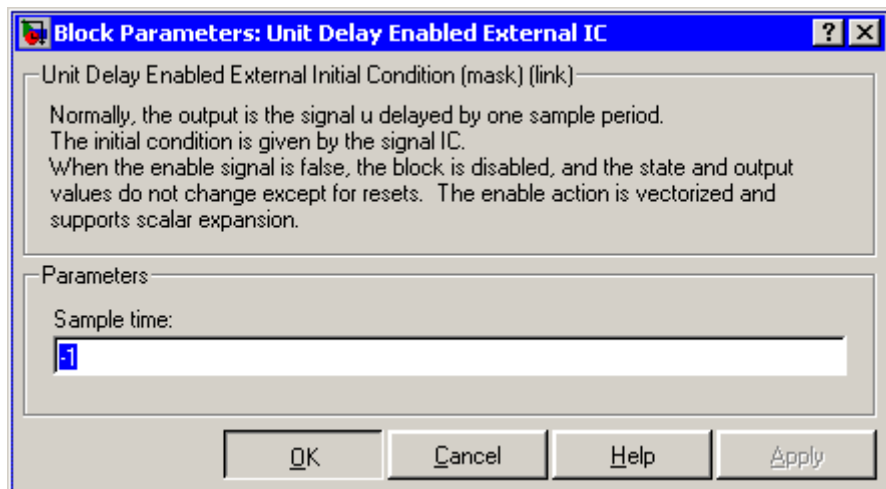

## Sample time

Specify the time interval between samples. To inherit the sample time, set this parameter to -1. See “Specifying Sample Time” in the online documentation for more information.

## Characteristics

Direct Feedthrough	Yes, of the reset input port No, of the enable input port Yes, of the external IC port
Sample Time	Specified in the <b>Sample time</b> parameter
Scalar Expansion	Yes

## See Also

Unit Delay, Unit Delay Enabled, Unit Delay Enabled Resettable, Unit Delay Enabled Resettable External IC, Unit Delay External IC, Unit Delay Resettable, Unit Delay Resettable External IC, Unit Delay With Preview Enabled, Unit Delay With Preview Enabled Resettable, Unit Delay With Preview Enabled Resettable External RV, Unit Delay With Preview Resettable, Unit Delay With Preview Resettable External RV

# Unit Delay Enabled Resettable

---

## Purpose

Delay signal one sample period, if external enable signal is on, with external Boolean reset

## Library

Additional Math & Discrete / Additional Discrete

## Description

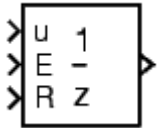

The Unit Delay Enabled Resettable block combines the features of the Unit Delay Enabled and Unit Delay Resettable blocks.

The block can reset its state based on an external reset signal R. When the enable signal E is on and the reset signal R is false, the block outputs the input signal delayed by one sample period.

When the enable signal E is on and the reset signal R is true, the block resets the current state to the initial condition, specified by the **Initial condition** parameter, and outputs that state delayed by one sample period.

When the enable signal is off, the block is disabled, and the state and output do not change except for resets. The enable signal is on when E is not 0, and off when E is 0.

You specify the time between samples with the **Sample time** parameter. A setting of -1 means the **Sample time** is inherited.

## Data Type Support

The Unit Delay Enabled Resettable block accepts signals of any data type supported by Simulink, including fixed-point data types.

# Unit Delay Enabled Resettable

## Parameters and Dialog Box

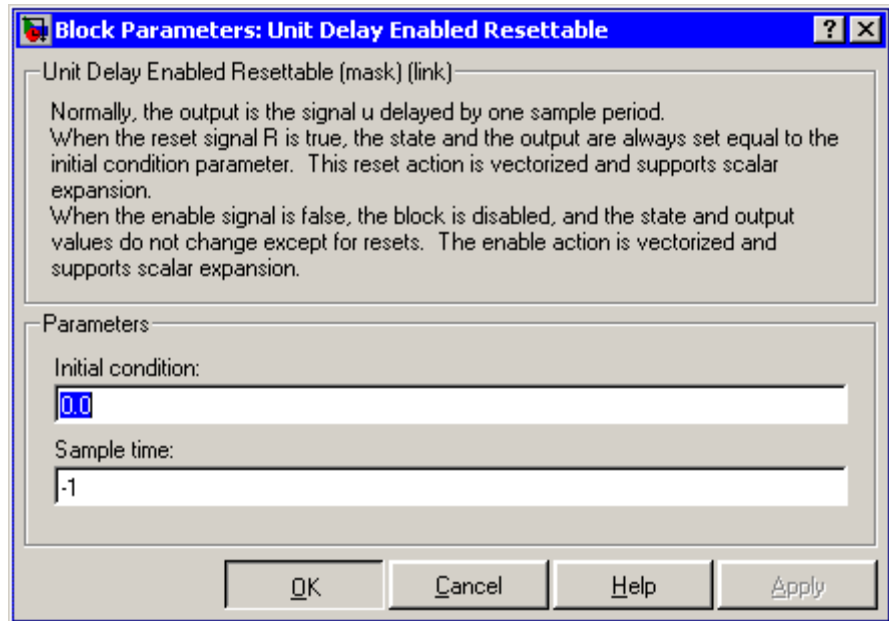

### Initial condition

The initial output of the simulation.

### Sample time

Specify the time interval between samples. To inherit the sample time, set this parameter to -1. See “Specifying Sample Time” in the online documentation for more information.

# Unit Delay Enabled Resettable

---

## Characteristics

Direct Feedthrough	No, of the input port No, of the enable port Yes, of the reset port
Sample Time	Specified in the <b>Sample time</b> parameter
Scalar Expansion	Yes

## See Also

Unit Delay, Unit Delay Enabled, Unit Delay Enabled External IC, Unit Delay Enabled Resettable External IC, Unit Delay External IC, Unit Delay Resettable, Unit Delay Resettable External IC, Unit Delay With Preview Enabled, Unit Delay With Preview Enabled Resettable, Unit Delay With Preview Enabled Resettable External RV, Unit Delay With Preview Resettable, Unit Delay With Preview Resettable External RV

# Unit Delay Enabled Resettable External IC

## Purpose

Delay signal one sample period, if external enable signal is on, with external Boolean reset and initial condition

## Library

Additional Math & Discrete / Additional Discrete

## Description

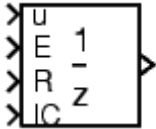

The Unit Delay Enabled Resettable External IC block combines the features of the Unit Delay Enabled, Unit Delay External IC, and Unit Delay Resettable blocks.

The block can reset its state based on an external reset signal R. When the enable signal E is on and the reset signal R is false, the block outputs the input signal delayed by one sample period.

When the enable signal E is on and the reset signal R is true, the block resets the current state to the initial condition given by the signal IC, and outputs that state delayed by one sample period.

When the enable signal is off, the block is disabled, and the state and output do not change except for resets. The enable signal is on when E is not 0, and off when E is 0.

The output data type is the same as the input u and the initial condition IC data type, which can be any data type, but must be the same. The enable E and reset R can be any data type.

You specify the time between samples with the **Sample time** parameter. A setting of -1 means the **Sample time** is inherited.

## Data Type Support

The Unit Delay Enabled Resettable External IC block accepts signals of any data type supported by Simulink, including fixed-point data types.

# Unit Delay Enabled Resetable External IC

## Parameters and Dialog Box

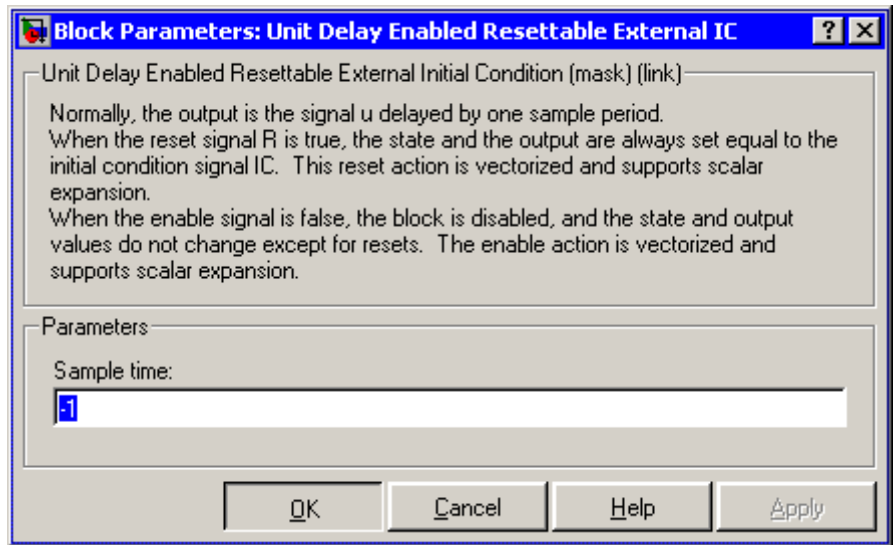

### Sample time

Specify the time interval between samples. To inherit the sample time, set this parameter to -1. See “Specifying Sample Time” in the online documentation for more information.

### Characteristics

Direct Feedthrough	No, of the input port No, of the enable port Yes, of the enable port Yes, of the external IC port
Sample Time	Specified in the <b>Sample time</b> parameter
Scalar Expansion	Yes

### See Also

Unit Delay, Unit Delay Enabled, Unit Delay Enabled External IC, Unit Delay Enabled Resetable, Unit Delay External IC, Unit Delay



# Unit Delay Enabled Resettable External IC

---

Resettable, Unit Delay Resettable External IC, Unit Delay With Preview Enabled, Unit Delay With Preview Enabled Resettable, Unit Delay With Preview Enabled Resettable External RV, Unit Delay With Preview Resettable, Unit Delay With Preview Resettable External RV

# Unit Delay External IC

## Purpose

Delay signal one sample period, with external initial condition

## Library

Additional Math & Discrete / Additional Discrete

## Description

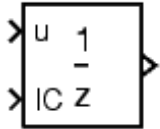

The Unit Delay External IC block delays its input by one sample period. This block is equivalent to the  $z^{-1}$  discrete-time operator. The block accepts one input and generates one output, both of which can be scalar or vector. If the input is a vector, all elements of the vector are delayed by the same sample period.

The block's output for the first sample period is equal to the signal IC.

The input  $u$  and initial condition IC data types must be the same, and are any data type.

You specify the time between samples with the **Sample time** parameter. A setting of -1 means the **Sample time** is inherited.

## Data Type Support

The Unit Delay External IC block accepts signals of any data type supported by Simulink, including fixed-point data types.

## Parameters and Dialog Box

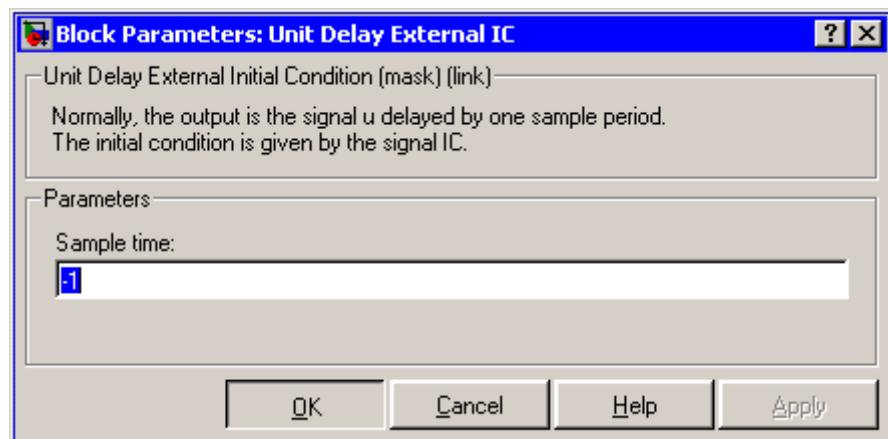

## Sample time

Specify the time interval between samples. To inherit the sample time, set this parameter to -1. See “Specifying Sample Time” in the online documentation for more information.

## Characteristics

Direct Feedthrough	No, of the input port Yes, of the external IC port
Sample Time	Specified in the <b>Sample time</b> parameter
Scalar Expansion	Yes

## See Also

Unit Delay, Unit Delay Enabled, Unit Delay Enabled External IC, Unit Delay Enabled Resettable, Unit Delay Enabled Resettable External IC, Unit Delay Resettable, Unit Delay Resettable External IC, Unit Delay With Preview Enabled, Unit Delay With Preview Enabled Resettable, Unit Delay With Preview Enabled Resettable External RV, Unit Delay With Preview Resettable, Unit Delay With Preview Resettable External RV

# Unit Delay Resettable

## Purpose

Delay signal one sample period, with external Boolean reset

## Library

Additional Math & Discrete / Additional Discrete

## Description

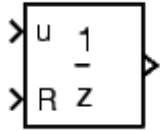

The Unit Delay Resettable block delays a signal one sample period.

The block can reset its state based on an external reset signal R. The block has two input ports, one for the input signal u and the other for the external reset signal R. When the reset signal is false, the block outputs the input signal delayed by one time step. When the reset signal is true, the block resets the current state to the initial condition, specified by the **Initial condition** parameter, and outputs that state delayed by one time step.

You specify the time between samples with the **Sample time** parameter. A setting of -1 means the **Sample time** is inherited.

## Data Type Support

The Unit Delay Resettable block accepts signals of any data type supported by Simulink, including fixed-point data types.

## Parameters and Dialog Box

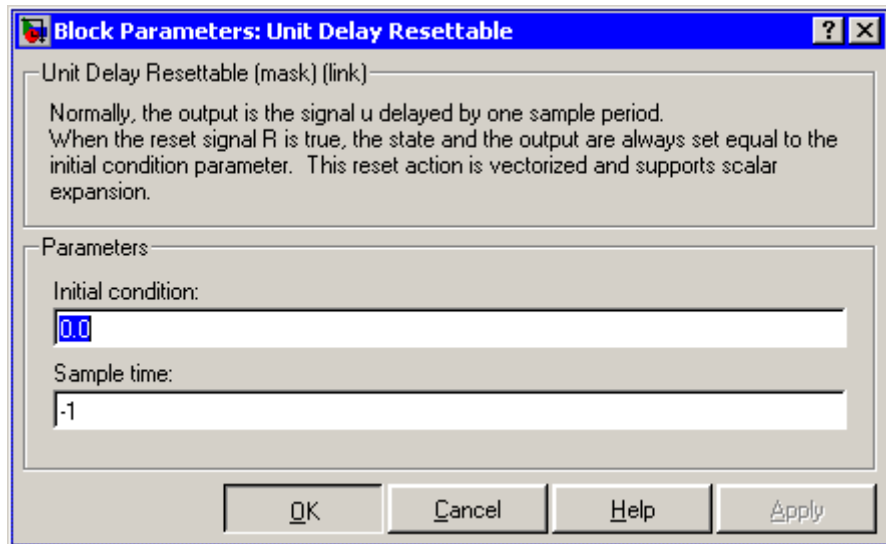

## Initial condition

Specify the initial output of the simulation.

## Sample time

Specify the time interval between samples. To inherit the sample time, set this parameter to -1. See “Specifying Sample Time” in the online documentation for more information.

## Characteristics

Direct Feedthrough	No, of the input port Yes, of the reset port
Sample Time	Specified in the <b>Sample time</b> parameter
Scalar Expansion	Yes

## See Also

Unit Delay, Unit Delay Enabled, Unit Delay Enabled External IC, Unit Delay Enabled Resettable, Unit Delay Enabled Resettable External IC, Unit Delay External IC, Unit Delay Resettable External IC, Unit Delay With Preview Enabled, Unit Delay With Preview Enabled Resettable, Unit Delay With Preview Enabled Resettable External RV, Unit Delay With Preview Resettable, Unit Delay With Preview Resettable External RV

# Unit Delay Resettable External IC

---

**Purpose** Delay signal one sample period, with external Boolean reset and initial condition

**Library** Additional Math & Discrete / Additional Discrete

**Description** The Unit Delay Resettable External IC block delays a signal one sample period.

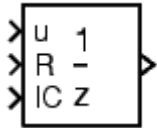

The block can reset its state based on an external reset signal R. The block has two input ports, one for the input signal u and the other for the reset signal R. When the reset signal is false, the block outputs the input signal delayed by one time step. When the reset signal is true, the block resets the current state to the initial condition given by the signal IC and outputs that state delayed by one time step.

The input u and initial condition IC must be the same data type, but can be any data type. The output is the same data type as the inputs u and IC. The reset R can be any data type.

You specify the time between samples with the **Sample time** parameter. A setting of -1 means the **Sample time** is inherited.

**Data Type Support** The Unit Delay Resettable External IC block accepts signals of any data type supported by Simulink, including fixed-point data types.

# Unit Delay Resettable External IC

## Parameters and Dialog Box

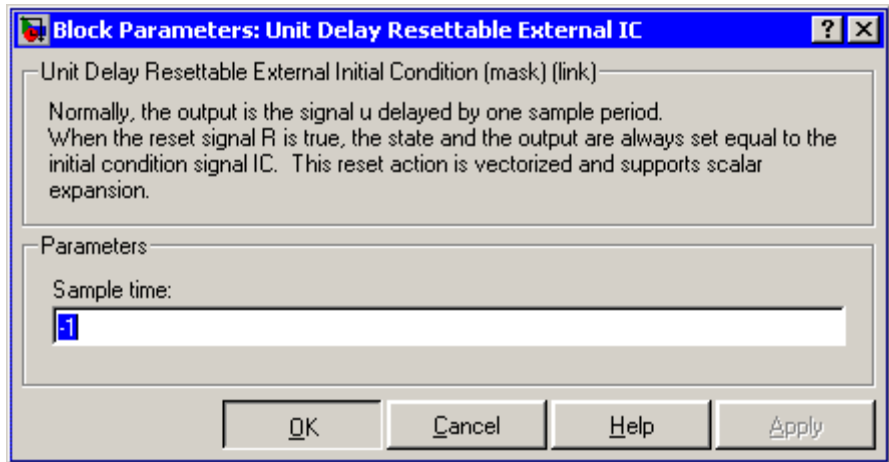

### Sample time

Specify the time interval between samples. To inherit the sample time, set this parameter to -1. See “Specifying Sample Time” in the online documentation for more information.

## Characteristics

Direct Feedthrough	No, of the input port Yes, of the reset port Yes, of the external IC port
Sample Time	Specified in the <b>Sample time</b> parameter
Scalar Expansion	Yes

## See Also

Unit Delay, Unit Delay Enabled, Unit Delay Enabled External IC, Unit Delay Enabled Resettable, Unit Delay Enabled Resettable External IC, Unit Delay External IC, Unit Delay Resettable, Unit Delay With Preview Enabled, Unit Delay With Preview Enabled Resettable, Unit Delay With Preview Enabled Resettable External RV, Unit Delay With Preview Resettable, Unit Delay With Preview Resettable External RV

# Unit Delay With Preview Enabled

---

**Purpose** Output signal and signal delayed by one sample period, if external enable signal is on

**Library** Additional Math & Discrete / Additional Discrete

**Description** The Unit Delay With Preview Enabled block supports calculations that have feedback and depend on the current input.

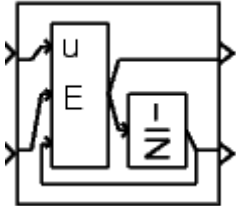

The block has two output ports. When the external enable signal  $E$  is on, the upper port outputs the signal and the lower port outputs the signal delayed by one sample period. The block has two input ports, one for the input signal  $u$  and the other for the enable signal  $E$ .

When the enable signal  $E$  is off, the block is disabled, and the state and output values do not change, except for resets. The enable signal is on when  $E$  is not 0, and off when  $E$  is 0.

You specify the block output for the first sampling period with the value of the **Initial condition** parameter.

The input  $u$  can be any data type. The output is the same data type as the input  $u$ .

You specify the time between samples with the **Sample time** parameter. A setting of -1 means the **Sample time** is inherited.

**Data Type Support** The Unit Delay With Preview Enabled block accepts signals of any data type supported by Simulink, including fixed-point data types.



# Unit Delay With Preview Enabled

## Parameters and Dialog Box

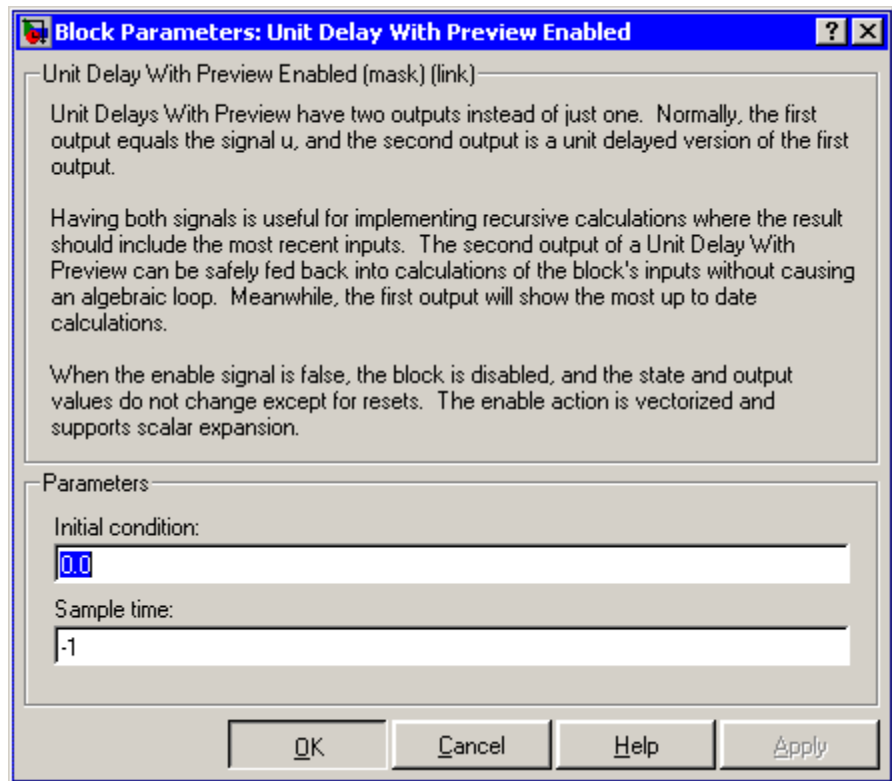

### Initial condition

Specify the initial condition.

### Sample time

Specify the time interval between samples. To inherit the sample time, set this parameter to -1. See "Specifying Sample Time" in the online documentation for more information.

# Unit Delay With Preview Enabled

---

<b>Characteristics</b>	Direct Feedthrough	Yes, to upper output port No, to lower output port
	Sample Time	Specified in the <b>Sample time</b> parameter
	Scalar Expansion	Yes

## See Also

Unit Delay, Unit Delay Enabled, Unit Delay Enabled External IC, Unit Delay Enabled Resettable, Unit Delay Enabled Resettable External IC, Unit Delay External IC, Unit Delay Resettable, Unit Delay Resettable External IC, Unit Delay With Preview Enabled Resettable, Unit Delay With Preview Enabled Resettable External RV, Unit Delay With Preview Resettable, Unit Delay With Preview Resettable External RV

# Unit Delay With Preview Enabled Resettable

## Purpose

Output signal and signal delayed by one sample period, if external enable signal is on, with external Boolean reset

## Library

Additional Math & Discrete / Additional Discrete

## Description

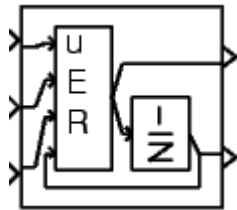

The Unit Delay With Preview Enabled Resettable block supports calculations that have feedback and depend on the current input.

The block can reset its state based on an external reset signal R. The block has two output ports. When the external enable signal E is on and the reset R is false, the upper port outputs the signal and the lower port outputs the signal delayed by one sample period. The block has three input ports, one for the input signal u, one for the enable signal E, and one for the reset signal R.

When the enable signal E is on and the reset R is true, the block resets the current state to the initial condition given by the **Initial condition** parameter. The block outputs that state delayed by one sample time through the lower output port, and outputs the state without a delay through the upper output port.

When the Enable signal is off, the block is disabled, and the state and output values do not change, except for resets. The enable signal is on when E is not 0, and off when E is 0.

The input u can be any data type. The output is the same data type as the input u. The reset R can be any data type.

You specify the time between samples with the **Sample time** parameter. A setting of -1 means the **Sample time** is inherited.

## Data Type Support

The Unit Delay With Preview Enabled Resettable block accepts signals of any data type supported by Simulink, including fixed-point data types.

# Unit Delay With Preview Enabled Resettable

## Parameters and Dialog Box

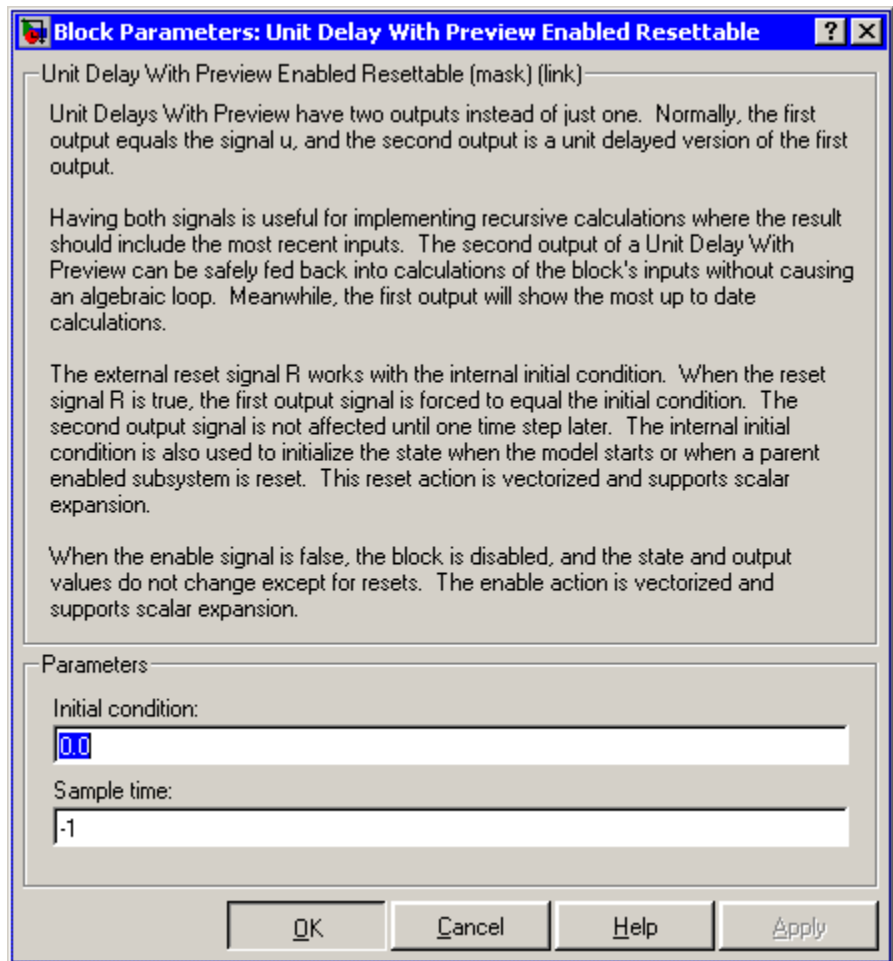

### Initial condition

Specify the initial condition.

# Unit Delay With Preview Enabled Resettable

---

## Sample time

Specify the time interval between samples. To inherit the sample time, set this parameter to -1. See “Specifying Sample Time” in the online documentation for more information.

## Characteristics

Direct Feedthrough	Yes, to upper output port No, to lower output port
Sample Time	Specified in the <b>Sample time</b> parameter
Scalar Expansion	Yes

## See Also

Unit Delay, Unit Delay Enabled, Unit Delay Enabled External IC, Unit Delay Enabled Resettable, Unit Delay Enabled Resettable External IC, Unit Delay External IC, Unit Delay Resettable, Unit Delay Resettable External IC, Unit Delay With Preview Enabled, Unit Delay With Preview Enabled Resettable External RV, Unit Delay With Preview Resettable, Unit Delay With Preview Resettable External RV

# Unit Delay With Preview Enabled Resettable External RV

## Purpose

Output signal and signal delayed by one sample period, if external enable signal is on, with external RV reset

## Library

Additional Math & Discrete / Additional Discrete

## Description

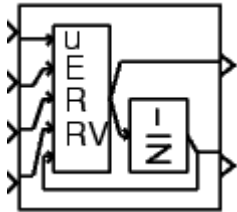

The Unit Delay With Preview Enabled Resettable External RV block supports calculations that have feedback and depend on the current input.

The block can reset its state based on an external reset signal R. The block has two output ports. When the external enable signal E is on and the reset R is false, the upper port outputs the signal and the lower port outputs the signal delayed by one sample period. The block has four input ports, one for the input signal u, one for the enable signal E, one for the reset signal R, and one for the external reset signal, RV.

When the enable signal E is on and the reset R is true, the upper output signal is forced to equal the external reset signal RV. The lower output signal is not affected until one time step later, at which time it is equal to the external reset signal RV at the previous time step. The block uses the internal **Initial condition** only when the model starts or when a parent enabled subsystem is used. The internal **Initial condition** only affects the lower output signal. The first output is only affected through feedback.

When the Enable signal is off, the block is disabled, and the state and output values do not change, except for resets. The enable signal is on when E is not 0, and off when E is 0.

The input u can be any data type. The output is the same data type as the input u. The reset R can be any data type.

You specify the time between samples with the **Sample time** parameter. A setting of -1 means the **Sample time** is inherited.

## Data Type Support

The Unit Delay With Preview Enabled Resettable External RV block accepts signals of any data type supported by Simulink, including fixed-point data types.

# Unit Delay With Preview Enabled Resettable External RV

## Parameters and Dialog Box

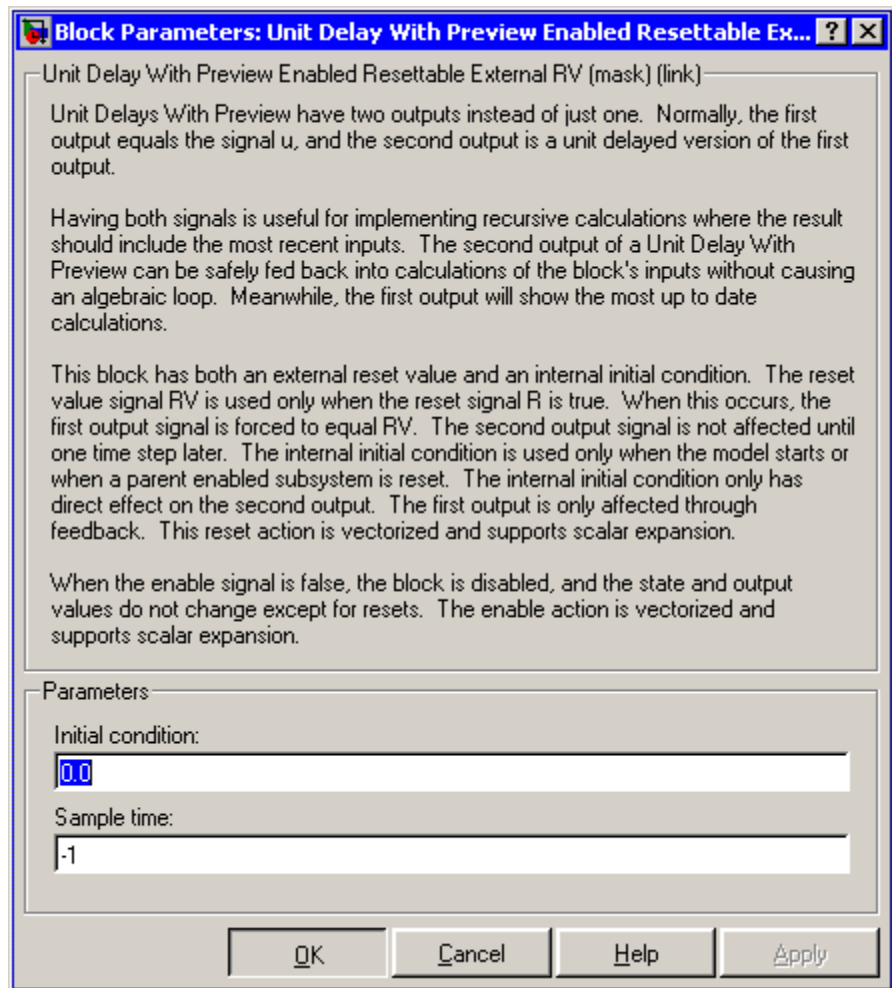

### Initial condition

Specify the initial condition.

# Unit Delay With Preview Enabled Resettable External RV

---

## Sample time

Specify the time interval between samples. To inherit the sample time, set this parameter to -1. See “Specifying Sample Time” in the online documentation for more information.

## Characteristics

Direct Feedthrough	Yes, to upper output port No, to lower output port
Sample Time	Specified in the <b>Sample time</b> parameter
Scalar Expansion	Yes

## See Also

Unit Delay, Unit Delay Enabled, Unit Delay Enabled External IC, Unit Delay Enabled Resettable, Unit Delay Enabled Resettable External IC, Unit Delay External IC, Unit Delay Resettable, Unit Delay Resettable External IC, Unit Delay With Preview Enabled, Unit Delay With Preview Enabled Resettable, Unit Delay With Preview Resettable, Unit Delay With Preview Resettable External RV



# Unit Delay With Preview Resettable

## Purpose

Output signal and signal delayed by one sample period, with external Boolean reset

## Library

Additional Math & Discrete / Additional Discrete

## Description

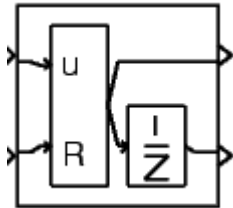

The Unit Delay With Preview Resettable block supports calculations that have feedback and depend on the current input.

The block can reset its state based on an external reset signal **R**. The block has two output ports. When the reset **R** is false, the upper port outputs the signal and the lower port outputs the signal delayed by one sample period.

When the reset **R** is true, the block resets the current state to the initial condition given by the **Initial condition** parameter. The block outputs that state delayed by one sample time through the lower output port, and outputs the state without a delay through the upper output port.

The input **u** can be any data type. The output is the same data type as the input **u**. The reset **R** can be any data type.

You specify the time between samples with the **Sample time** parameter. A setting of -1 means the **Sample time** is inherited.

## Data Type Support

The Unit Delay With Preview Resettable block accepts signals of any data type supported by Simulink, including fixed-point data types.

# Unit Delay With Preview Resettable

## Parameters and Dialog Box

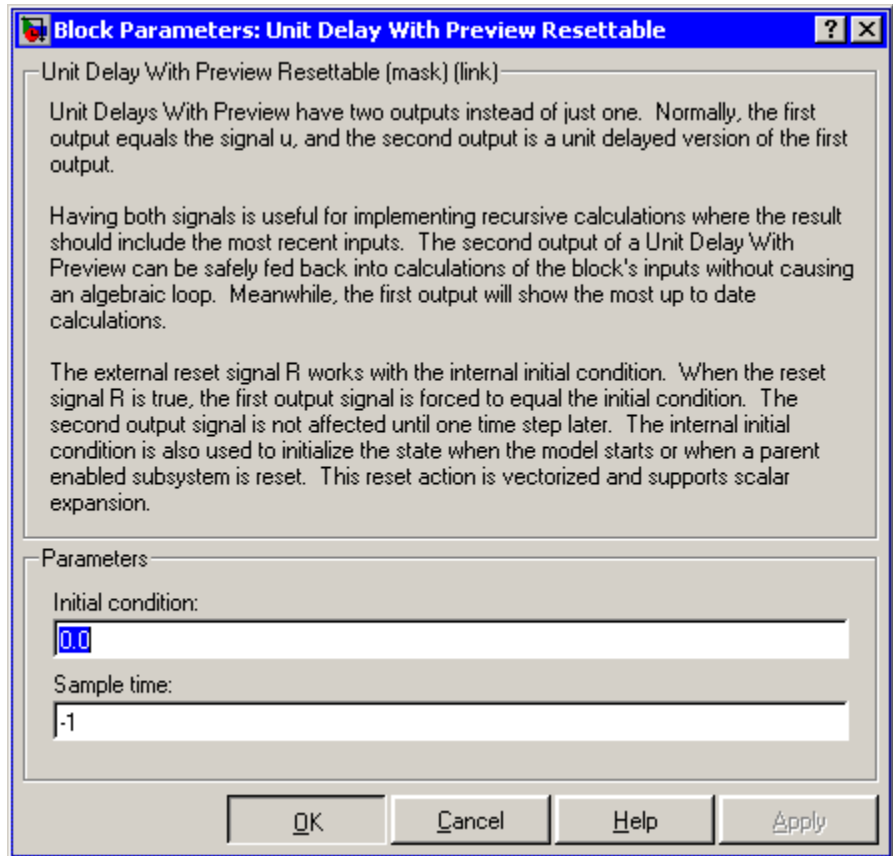

### Initial condition

Specify the initial condition.

### Sample time

Specify the time interval between samples. To inherit the sample time, set this parameter to -1. See “Specifying Sample Time” in the online documentation for more information.

# Unit Delay With Preview Resettable

---

<b>Characteristics</b>	Direct Feedthrough	Yes, to upper output port No, to lower output port
	Sample Time	Specified in the <b>Sample time</b> parameter
	Scalar Expansion	Yes

## See Also

Unit Delay, Unit Delay Enabled, Unit Delay Enabled External IC, Unit Delay Enabled Resettable, Unit Delay Enabled Resettable External IC, Unit Delay External IC, Unit Delay Resettable, Unit Delay Resettable External IC, Unit Delay With Preview Enabled, Unit Delay With Preview Enabled Resettable, Unit Delay With Preview Enabled Resettable External RV, Unit Delay With Preview Resettable External RV

# Unit Delay With Preview Resettable External RV

**Purpose** Output signal and signal delayed by one sample period, with external RV reset

**Library** Additional Math & Discrete / Additional Discrete

**Description** The Unit Delay With Preview Resettable External RV block supports calculations that have feedback and depend on the current input.

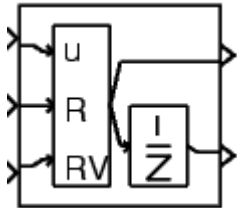

The block can reset its state based on an external reset signal R. The block has two output ports. When the external reset R is false, the upper port outputs the signal and the lower port outputs the signal delayed by one sample period.

When the external reset R is true, the upper output signal is forced to equal the external reset signal RV. The lower output signal is not affected until one time step later, at which time it is equal to the external reset signal RV at the previous time step. The block uses the internal **Initial condition** only when the model starts or when a parent enabled subsystem is used. The internal **Initial condition** only affects the lower output signal. The first output is only affected through feedback.

The input u can be any data type. The output is the same data type as the input u. The reset R can be any data type.

You specify the time between samples with the **Sample time** parameter. A setting of -1 means the **Sample time** is inherited.

**Data Type Support** The Unit Delay With Preview Resettable External RV block accepts signals of any data type supported by Simulink, including fixed-point data types.

# Unit Delay With Preview Resettable External RV

## Parameters and Dialog Box

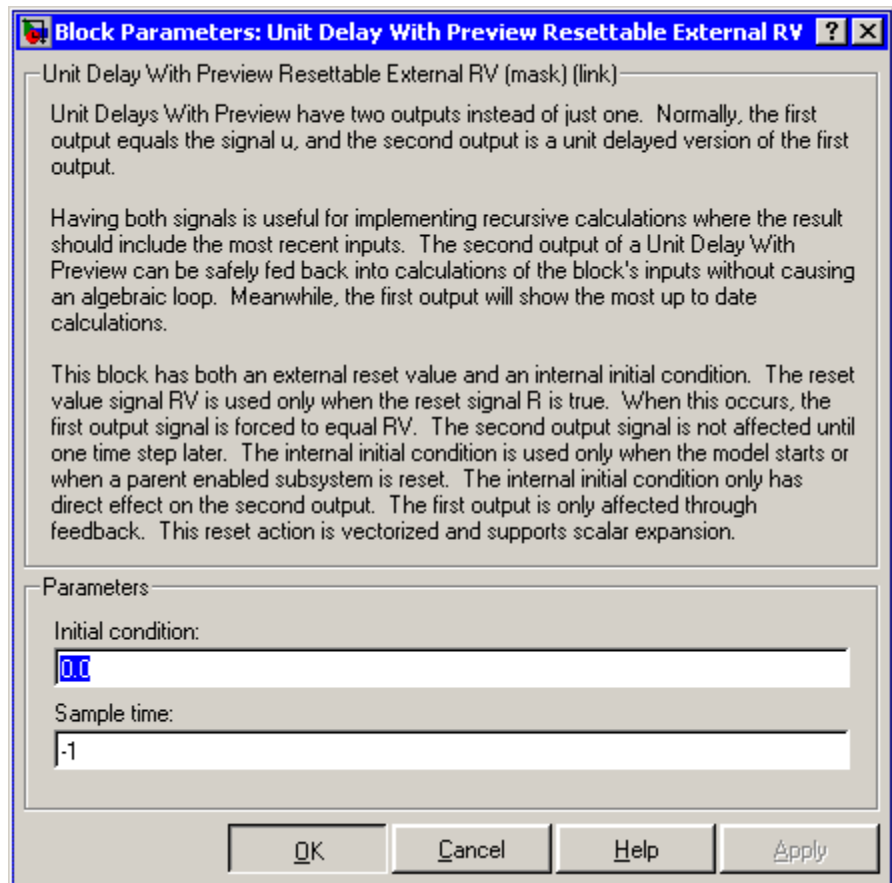

### Initial condition

Specify the initial condition.

### Sample time

Specify the time interval between samples. To inherit the sample time, set this parameter to -1. See “Specifying Sample Time” in the online documentation for more information.

# Unit Delay With Preview Resettable External RV

---

<b>Characteristics</b>	Direct Feedthrough	Yes, to upper output port No, to lower output port
	Sample Time	Specified in the <b>Sample time</b> parameter
	Scalar Expansion	Yes

## See Also

Unit Delay, Unit Delay Enabled, Unit Delay Enabled External IC, Unit Delay Enabled Resettable, Unit Delay Enabled Resettable External IC, Unit Delay External IC, Unit Delay Resettable, Unit Delay Resettable External IC, Unit Delay With Preview Enabled, Unit Delay With Preview Enabled Resettable, Unit Delay With Preview Enabled Resettable External RV, Unit Delay With Preview Resettable

# Variable Time Delay, Variable Transport Delay

**Purpose** Delay input by variable amount of time

**Library** Continuous

## Description



The Variable Transport Delay and Variable Time Delay appear as two blocks in the Simulink block library. However, they are actually the same built-in Simulink block with different settings of a **Select delay type** parameter. This parameter allows you to specify that the block operate in either of the following modes.

### Variable Time Delay

In this mode, the block has a data input a time delay input, and a data output. (See “Changing the Orientation of a Block” in Using Simulink for a description of the port order for various block orientations.) The block’s output at the current time step equals the value of its data input at a previous time equal to the current simulation time minus a delay time specified by the block’s time delay input.

$$y(t) = u(t - t_0) = u(t - \tau(t))$$

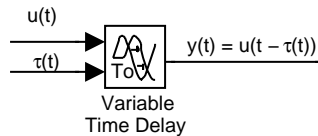

The block’s **Maximum delay** parameter defines the largest value the time delay input can have. The block clips values of the delay that exceed this value. The **Maximum delay** must be greater than or equal to zero. If the time delay becomes negative, the block clips it to zero and issues a warning message.

During the simulation, the block stores time and input value pairs in an internal buffer. At the start of the simulation, the block outputs the value of the **Initial output** parameter until the simulation time exceeds the time delay input. Then, at each simulation step, the

# Variable Time Delay, Variable Transport Delay

---

block outputs the signal at the time that corresponds to the current simulation time minus the delay time.

When output is required at a time that does not correspond to the times of the stored input values and the solver is a continuous solver, the block interpolates linearly between points. If the time delay is smaller than the step size, the block extrapolates an output point from a previous point. For example, consider a fixed-step simulation with a step size of 1 and the current time at  $t = 5$ . If the delay is 0.5, the block needs to generate a point at  $t = 4.5$ . Because the most recent stored time value is at  $t = 4$ , the block extrapolates the input at 4.5 from the input at 4 and uses the extrapolated value as its output at  $t = 5$ .

Extrapolating forward from the previous time step can produce a less accurate result than extrapolating back from the current time step. However, the block cannot use the current input to calculate its output value because the input port does not have direct feedthrough.

If the model specifies a discrete solver, the block does not interpolate between time steps. Instead, it returns the nearest stored value that precedes the required value.

## Variable Transport Delay

In this mode, the block's output at the current time step is equal to the value of its data (top, or left) input at an earlier time equal to the current time minus a transportation delay

$$y(t) = u(t - t_d(t))$$

Simulink finds the transportation delay,  $t_d(t)$ , by solving the following equation

$$\int_{t-t_d(t)}^t \frac{1}{t_i(\tau)} d\tau = 1$$

This equation involves an instantaneous time delay,  $t_i(t)$ , given by the block's time delay (bottom, or right) input.



# Variable Time Delay, Variable Transport Delay

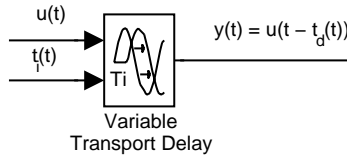

For example, suppose you want to use this block to model the flow of a fluid through a pipe where the speed of the flow varies with time. In this case, the time delay input to the block would be

$$t_i(t) = \frac{L}{v_i(t)}$$

where  $L$  is the length of the pipe and  $v_i(t)$  is the speed of the fluid.

## Data Type Support

The Variable Time Delay and Variable Transport Delay blocks accept and output real signals of type double.

## Parameters and Dialog Box

The block's parameters and dialog box differ, depending on whether it is operating in variable time or variable transport delay mode. Most parameters exist in both modes. The following sections note parameters that exist only in one mode.

### Variable Time Delay Parameters and Dialog Box

The dialog box for the Variable Time Delay block appears as follows.

# Variable Time Delay, Variable Transport Delay

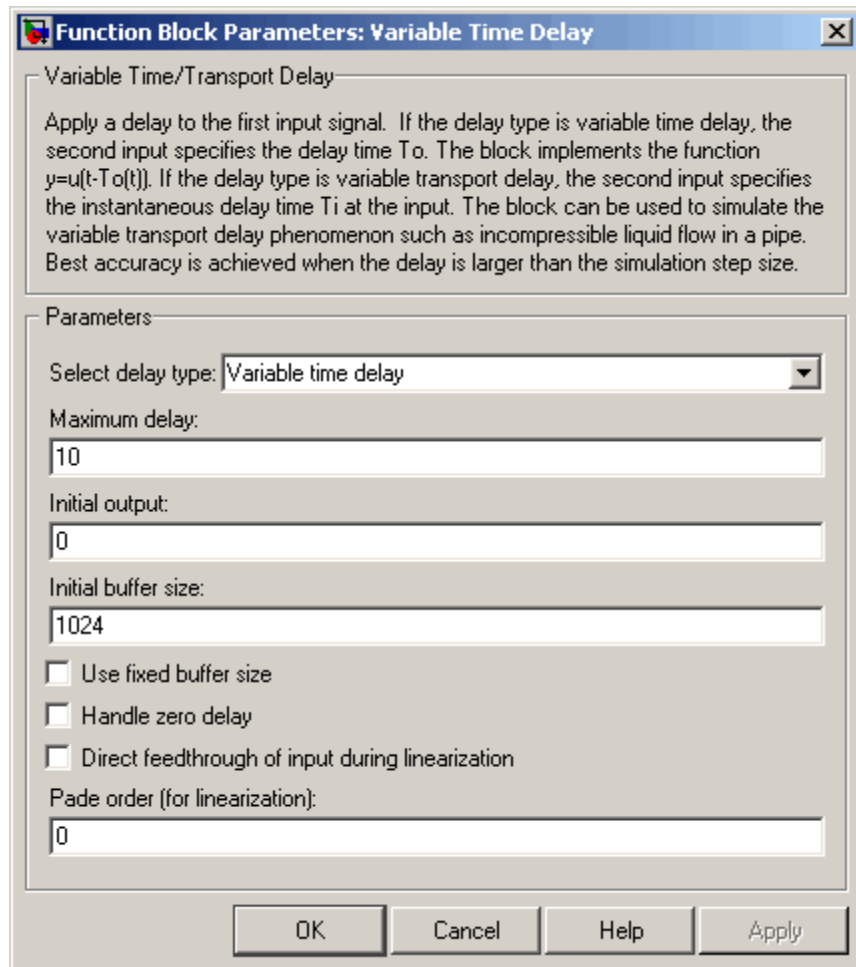

## Select delay type

The delay type of the block. The Variable Time Delay block in the Simulink library has a preset value of Variable time delay. The Variable Transport Delay block has a preset value of Variable transport delay.

# Variable Time Delay, Variable Transport Delay

---

## **Maximum delay**

The maximum value of the time delay input. The value cannot be negative. The default is 10.

## **Initial output**

The output generated by the block until the simulation time first exceeds the time delay input. The default is 0. Simulink does not allow the initial output of this block to be `inf` or `NaN`.

## **Initial buffer size**

Initial size of the buffer used to store previous input values. The default is 1024.

## **Use fixed buffer size**

Specifies use of a fixed-size buffer to save input data from previous time steps. The **Initial buffer size** parameter specifies the buffer's size. If the buffer is full, new data replaces data already in the buffer. Simulink uses linear extrapolation to estimate the output value if it is not in the buffer. This option can save memory if the input data is linear. If the input is not linear, this option may yield inaccurate results.

---

**Note** ERT or GRT code generation uses a fixed-size buffer even if you do not select this check box.

---

## **Handle zero delay**

For Variable time delay mode. Turns this block into a direct feedthrough block.

## **Direct feedthrough of input during linearization**

Causes the block to output its input during linearization and trim. This sets the block's mode to direct feedthrough.

Enabling this check box can cause a change in the ordering of states in the model when using the functions `linmod`, `dlinmod`, or `trim`. To extract this new state ordering, use the following commands.

# Variable Time Delay, Variable Transport Delay

---

First compile the model using the following command, where `model` is the name of the Simulink model.

```
[sizes, x0, x_str] = model([],[],[],'lincompile');
```

Next, terminate the compilation with the following command.

```
model([],[],[],'term');
```

The output argument, `x_str`, which is a cell array of the states in the Simulink model, contains the new state ordering. When passing a vector of states as input to the `linmod`, `dlinmod`, or `trim` functions, the state vector must use this new state ordering.

## **Pade order (for linearization)**

The order of the Pade approximation for linearization routines. The default value is 0, which results in a unity gain with no dynamic states. Setting the order to a positive integer `n` adds `n` states to your model, but results in a more accurate linear model of the transport delay.

## **Variable Transport Delay Parameters and Dialog Box**

The block's dialog box in Variable Transport Delay mode appears as follows.

# Variable Time Delay, Variable Transport Delay

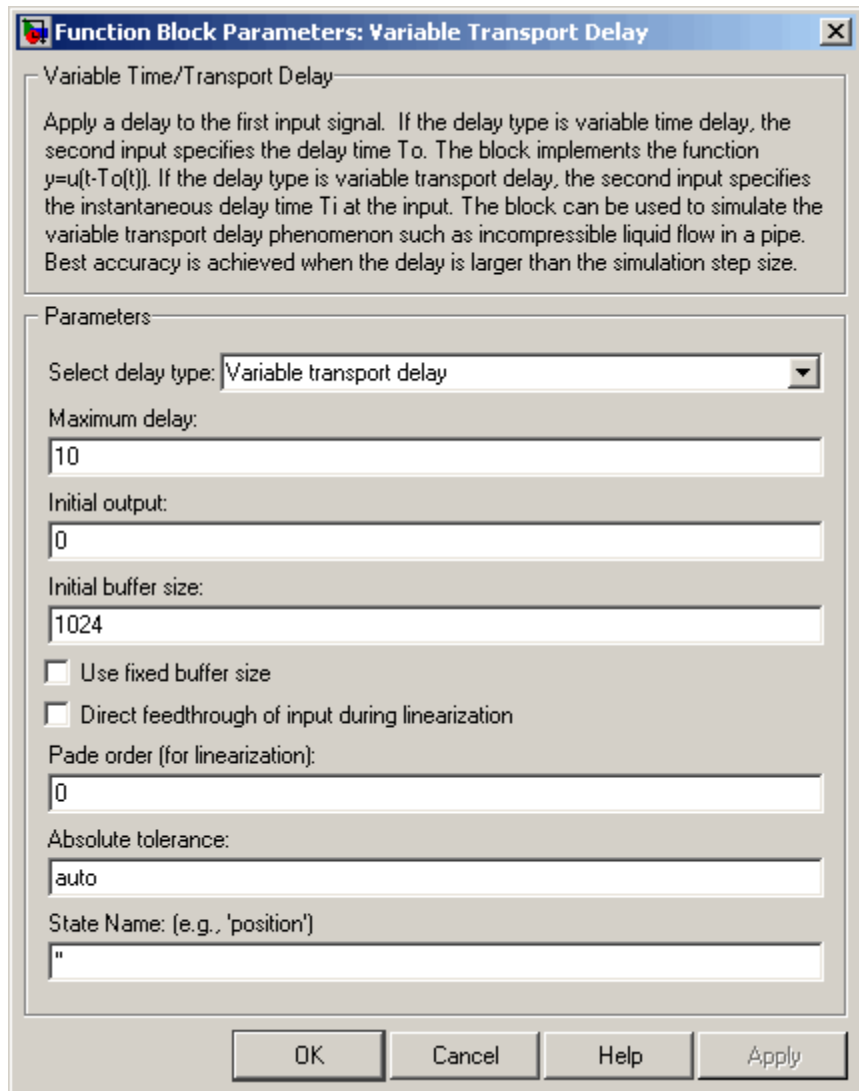

This mode adds the following parameter.

# Variable Time Delay, Variable Transport Delay

---

## Absolute tolerance

Absolute tolerance used to solve the block's states. You can enter auto or a numeric value. If you enter auto, Simulink determines the absolute tolerance (see "Absolute tolerance"). If you enter a numeric value, Simulink uses the specified value to solve the block's states. Note that a numeric value overrides the setting for the absolute tolerance in the **Configuration Parameters** dialog box.

## State Name

Use this to assign a unique name to each state. The state names apply only to the selected block. If left blank, no name is assigned.

To assign a name to a single state, enter the name between quotes, for example, 'velocity'.

To assign names to multiple states, enter a comma-delimited list surrounded by braces. For example, {'a', 'b', 'c'}. Each name must be unique.

The number of states must be evenly divided by the number of state names. There can be fewer names than the number of states, but there cannot be more names than states.

For example, you can specify two names in a system with four states. Simulink will assign the first name to the first two states and the second name to the last two.

To assign state names with a variable that has been defined in the MATLAB workspace, enter the variable without quotes. A variable can be a string, cell, or structure.

## Characteristics

Direct Feedthrough	Yes, of the time delay (second) input
Sample Time	Continuous

# Variable Time Delay, Variable Transport Delay

---

Scalar Expansion	Yes, of input and all parameters except <b>Initial buffer size</b>
Dimensionalized	Yes
Zero Crossing	No

# Weighted Moving Average

---

**Purpose** Implement weighted moving average

**Library** Discrete

## Description



The Weighted Moving Average block samples and holds the  $N$  most recent inputs, multiplies each input by a specified value (given by the **Weights** parameter), and stacks them in a vector. This block supports both single-input/single-output (SISO) and single-input/multi-output (SIMO) modes.

For the SISO mode, the **Weights** parameter is specified as a row vector. For the SIMO mode, the weights are specified as a matrix where each row corresponds to a separate output. You can choose whether or not to specify the data type and scaling of the weights in the dialog with the **Gain data type** parameter.

The **Initial condition** parameter provides the initial values for all times preceding the start time. You specify the time interval between samples with the **Sample time** parameter.

The Weighted Moving Average block first multiplies its inputs by the **Weights** parameter, converts those results to the output data type using the specified rounding and overflow modes, and then carries out the summation.

## Data Type Support

The Weighted Moving Average block supports all data types supported by Simulink, including fixed-point data types.



## Parameters and Dialog Box

The **Main** pane of the Weighted Moving Average block dialog appears as follows:

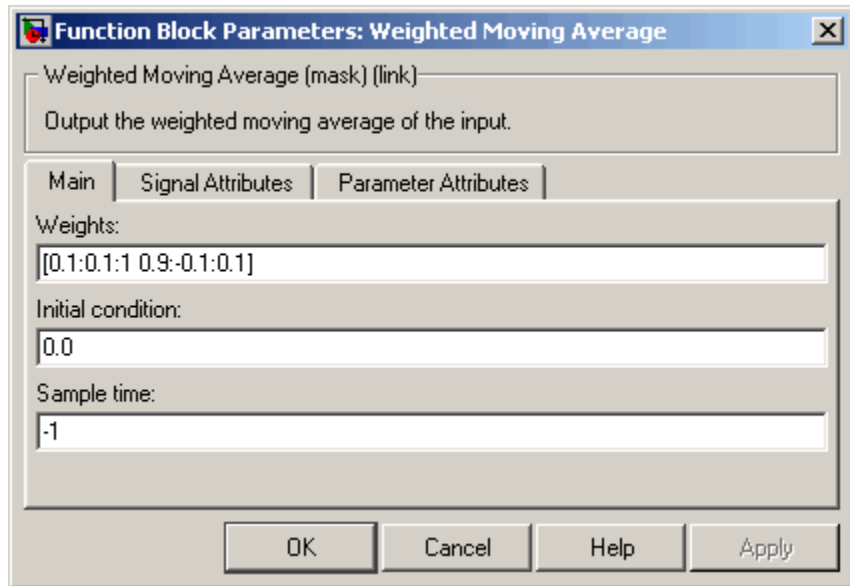

### Weights

Specify the weights of the moving average; one row per output.

The **Weights** parameter is converted from doubles to the specified data type offline using round-to-nearest and saturation.

### Initial condition

Specify the initial values for all times preceding the start time.

The **Initial condition** parameter is converted from doubles to the input data type offline using round-to-nearest and saturation.

### Sample time

Specify the time interval between samples. To inherit the sample time, set this parameter to -1. See “Specifying Sample Time” in the online documentation for more information.

# Weighted Moving Average

The **Signal Attributes** pane of the Weighted Moving Average block dialog appears as follows:

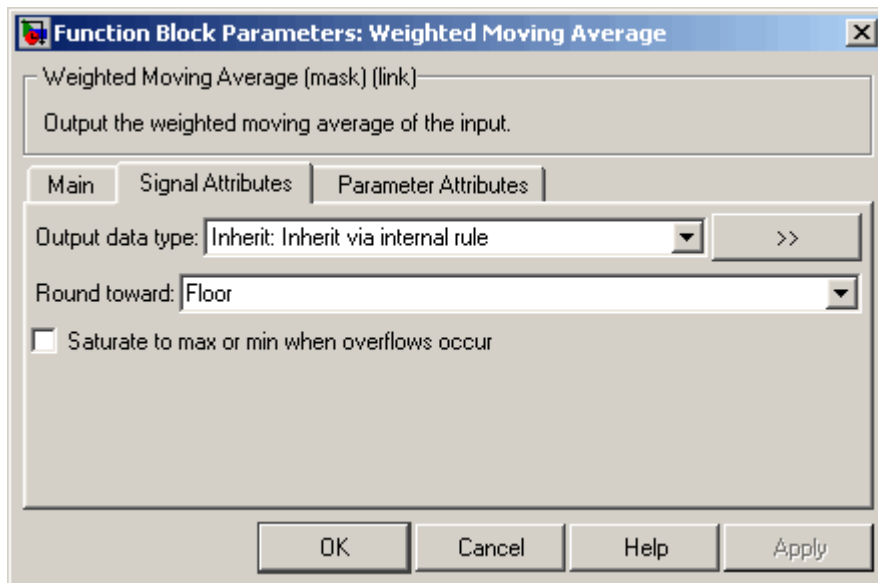

## Output data type

Specify the output data type. You can set it to:

- A rule that inherits a data type, for example, `Inherit: Inherit via back propagation`
- The name of a data type object, for example, a `Simulink.NumericType` object
- An expression that evaluates to a data type, for example, `float('single')`

Click the **Show data type assistant** button  to display the **Data Type Assistant**, which helps you set the **Output data type** parameter.

# Weighted Moving Average

See “Specifying Block Output Data Types” in *Using Simulink* for more information.

## Lock output scaling against changes by the autoscaling tool

Select to lock scaling of outputs. This parameter is visible only if you enter an expression for the **Output data type** parameter.

## Round toward

Rounding mode for the fixed-point output.

## Saturate to max or min when overflows occur

If selected, fixed-point overflows saturate.

The **Parameter Attributes** pane of the Weighted Moving Average block dialog appears as follows:

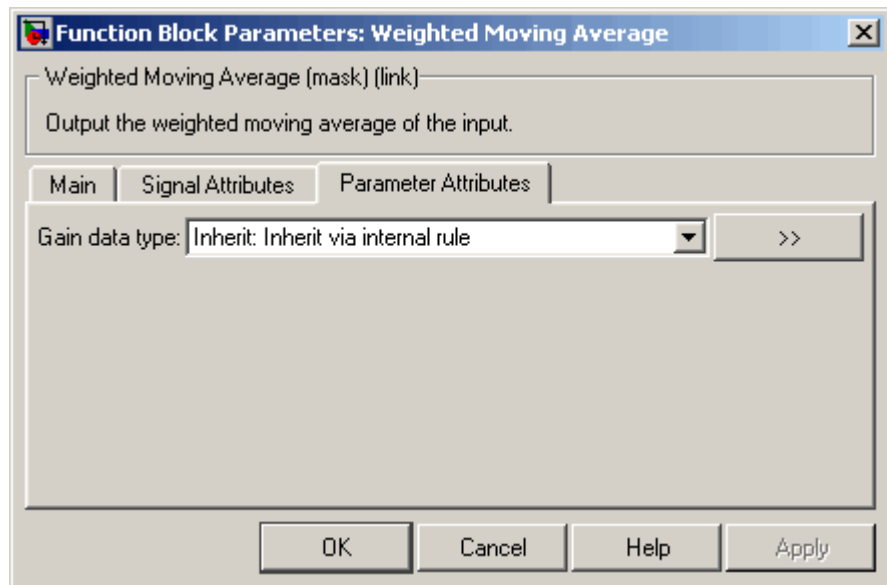

## Gain data type

Specify the data type of the **Weights** parameter. You can set it to:

# Weighted Moving Average

---

- A rule that inherits a data type, for example, Inherit: Inherit via internal rule
- The name of a data type object, for example, a Simulink.NumericType object
- An expression that evaluates to a data type, for example, fixdt(1,16,0)

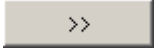
Click the **Show data type assistant** button  to display the **Data Type Assistant**, which helps you set the **Gain data type** parameter. (See “Using the Data Type Assistant” in *Using Simulink*.)

## Examples

Suppose you want to configure this block for two outputs (SIMO mode) where the first output is given by

$$y_1(k) = a_1 \cdot u(k) + b_1 \cdot u(k - 1) + c_1 \cdot u(k - 2)$$

the second output is given by

$$y_2(k) = a_2 \cdot u(k) + b_2 \cdot u(k - 1)$$

and the initial values of  $u(k - 1)$  and  $u(k - 2)$  are given by ic1 and ic2, respectively. To configure the Weighted Moving Average block for this situation, you must specify the **Weights** parameter as [a1 b1 c1; a2 b2 c2] where  $c_2 = 0$ , and the **Initial condition** parameter as [ic1 ic2].

## Characteristics

Direct Feedthrough	Yes
Scalar Expansion	Yes, of initial conditions

**Purpose** Support calculations involving sample time

**Library** Signal Attributes

**Description** The Weighted Sample Time block is an implementation of the Weighted Sample Time Math block. See Weighted Sample Time Math for more information.

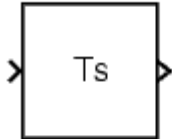

# Weighted Sample Time Math

---

**Purpose** Support calculations involving sample time

**Library** Math Operations

**Description** The Weighted Sample Time Math block adds, subtracts, multiplies, or divides its input signal,  $u$ , by a weighted sample time  $T_s$ . If the input signal is continuous,  $T_s$  is the sample time of the Simulink model. Otherwise,  $T_s$  is the sample time of the discrete input signal.

You specify the math operation with the **Operation** parameter. Additionally, you can specify to use only the weight with either the sample time or its inverse.

Enter the weighting factor in the **Weight value** parameter. If the weight,  $w$ , is 1, Simulink refrains from displaying it in the equation on the block icon.

The block computes its output using the precedence rules for MATLAB operators (see “Operator Precedence” in the MATLAB documentation). For example, if the **Operation** parameter specifies  $+$ , the block calculates its output using the equation

$$u + (T_s * w)$$

In contrast, if the **Operation** parameter specifies  $/$ , the block calculates its output using the equation

$$(u / T_s) / w$$

**Data Type Support** The Weighted Sample Time Math block accepts signals of any data type supported by Simulink, including fixed-point data types.

## Parameters and Dialog Box

The **Main** pane of the Weighted Sample Time Math block dialog appears as follows:

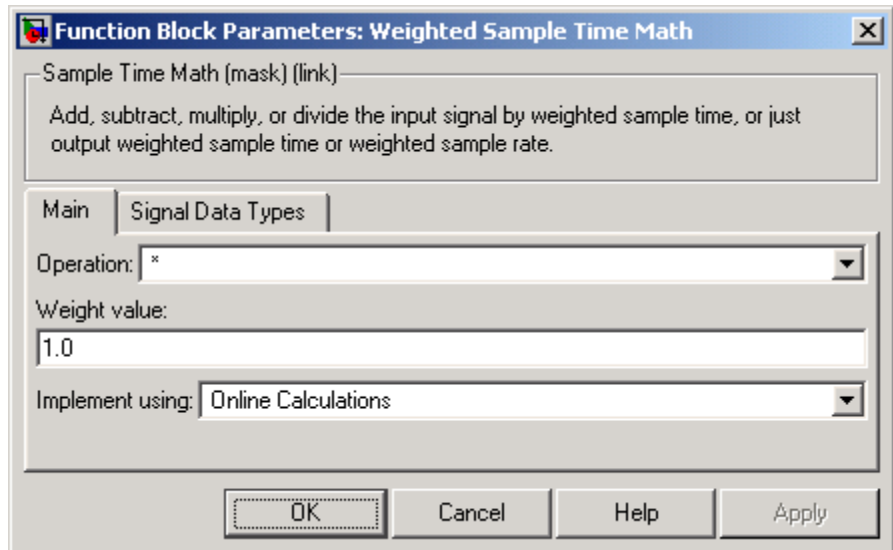

### Operation

Specify operation to use: +, -, \*, /, Ts Only, or 1/Ts Only.

### Weight value

Enter weight of sample time.

### Implement using

Specify online calculations or offline scaling adjustment. This parameter is visible only if you specify \* or / as the **Operation** parameter.

The **Signal Data Types** pane of the Weighted Sample Time Math block dialog appears as follows:

# Weighted Sample Time Math

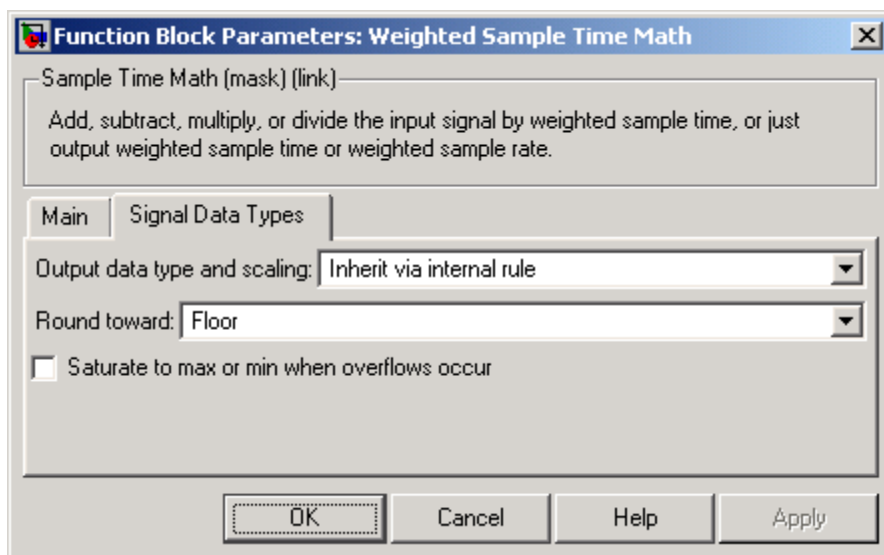

## Output data type and scaling

Specify whether the output data type and scaling are inherited by an internal rule or by backpropagation.

## Round toward

Select the rounding mode for fixed-point operations. This parameter is visible only if

- The **Operation** parameter specifies + or -.
- The **Operation** parameter specifies \* or / and the **Implement using** parameter specifies Online Calculations.

## Saturate to max or min when overflows occur

If selected, fixed-point overflows saturate. This parameter is visible only if

- The **Operation** parameter specifies + or -.
- The **Operation** parameter specifies \* or / and the **Implement using** parameter specifies Online Calculations.



# Weighted Sample Time Math

---

<b>Characteristics</b>	Direct Feedthrough	For all math operations options except Ts and 1/Ts
	Scalar Expansion	No, the weight is always a scalar

# While Iterator

---

## Purpose

Repeatedly execute contents of subsystem at current time step while condition is satisfied

## Library

Ports & Subsystems / While Iterator Subsystem

## Description

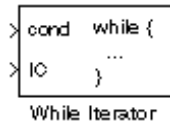

The While Iterator block, when placed in a subsystem, repeatedly executes the contents of the subsystem at the current time step while a specified condition is true.

---

**Note** Placing a While Iterator block in a subsystem makes it an atomic subsystem if it is not already an atomic subsystem.

---

The output of a While Iterator subsystem can not be a function-call signal. Simulink will display an error message if the simulation is run or the diagram updated.

You can use this block to implement the block-diagram equivalent of a C program while or do-while loop. In particular, the block's **While loop style** parameter allows you to choose either of the following while loop modes:

- do-while

In this mode, the While Iterator block has one input, the while condition input, whose source must reside in the subsystem. At each time step, the block runs all the blocks in the subsystem once and then checks whether the while condition input is true. If the input is true, the iterator block runs the blocks in the subsystem again. This process continues as long as the while condition input is true and the number of iterations is less than or equal to the iterator block's **Maximum number of iterations** parameter.

- while

In this mode, the iterator block has two inputs: a while condition input and an initial condition (IC) input. The source of the initial condition signal must be external to the while subsystem. At the

beginning of the time step, if the IC input is true, the iterator block executes the contents of the subsystem and then checks the while condition input. If the while condition input is true, the iterator executes the subsystem again. This process continues as long as the while condition input is true and the number of iterations is less than or equal to the iterator block's **Maximum number of iterations** parameter. If the IC input is false at the beginning of a time step, the iterator does not execute the contents of the subsystem during the time step.

---

**Note** Unless you are certain that the while condition will become false at some point in the simulation, you should specify a maximum number of iterations to avoid endless loops, which can be broken only by terminating MATLAB.

---

The While Iterator block can optionally output the current iteration number, starting at 1. The following example uses this capability to compute  $N$ , where  $N$  is the first  $N$  integers whose sum is less than 100.

# While Iterator

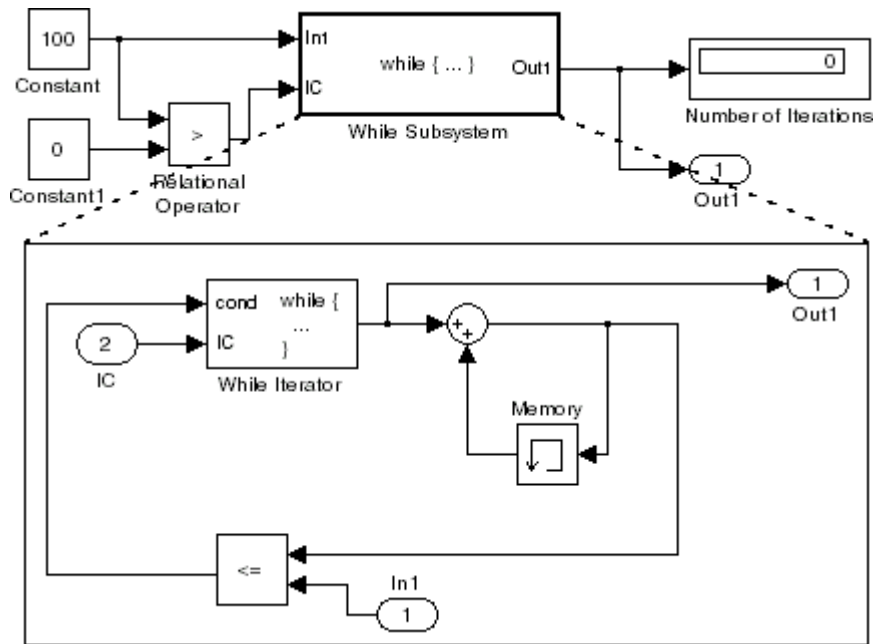

This example is the diagrammatic equivalent to the following pseudocode.

```
max_sum = 100;
sum = 0;
iteration_number = 0;
cond = (max_sum > 0);
while (cond != 0) {
    iteration_number = iteration_number + 1;
    sum = sum + iteration_number;
    if (sum > max_sum OR iteration_number > max_iterations)
        cond = 0;
}
```

## Data Type Support

Acceptable data inputs for the condition ports are any type supported by Simulink, as well as any fixed-point type, that includes a 0 value. For a discussion on the data types supported by Simulink, see “Data Types Supported by Simulink” in the Simulink documentation.

The While Iterator block’s optional output port can output any of the following data types: double, int32, int16, or int8.

## Parameters and Dialog Box

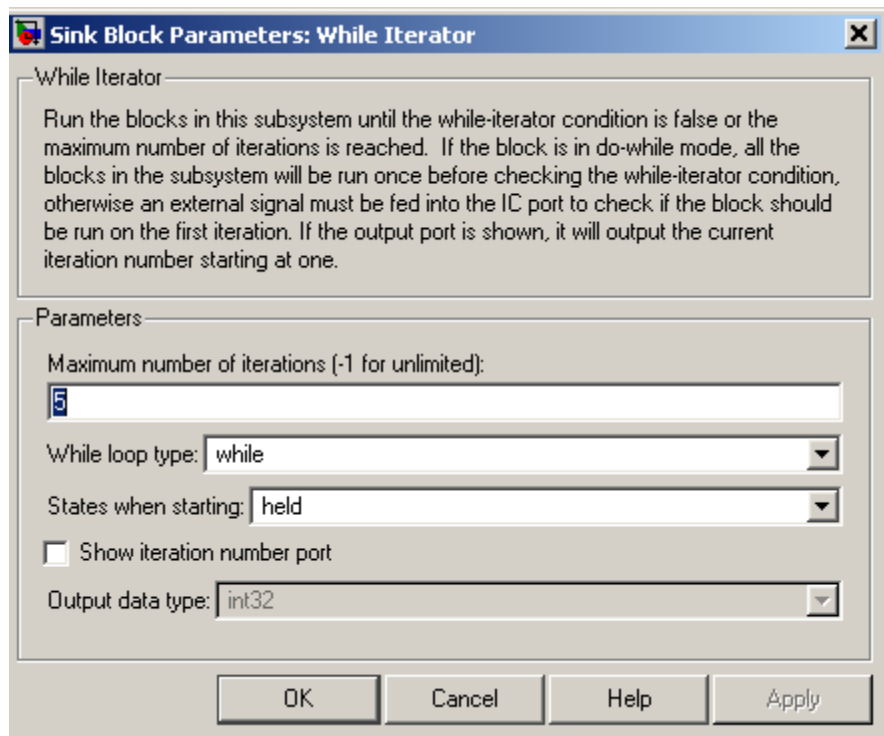

### Maximum number of iterations

The maximum number of iterations allowed. A value of -1 allows any number of iterations as long as the while condition input is true. Note that if you specify -1 and the while condition never becomes false, the simulation will run forever. In this case, the

# While Iterator

---

only way to stop the simulation is to terminate the MATLAB process. Therefore, you should not specify -1 as the value of this parameter unless you are certain that the while condition will become false at some point in the simulation.

## While loop style

Specifies the type of while loop implemented by this block. See the preceding block description for more information.

## States when starting

Set this field to reset if you want the iterator block to reset the states of the blocks in the while subsystem to their initial values at the beginning of each time step (i.e., before executing the first loop iteration in the current time step). To cause the states of blocks in the subsystem to persist across time steps, set this field to held (the default).

## Show iteration number port

If you select this check box, the While Iterator block outputs its iteration value. This value starts at 1 and is incremented by 1 for each succeeding iteration. By default, this check box is not selected.

## Output data type

If you select the **Show iteration number port** check box (the default), this field is enabled. Use it to set the data type of the iteration number output to int32, int16, int8, or double.

## Characteristics

Direct Feedthrough	No
Sample Time	Inherited from driving block
Scalar Expansion	No
Dimensionalized	No
Zero Crossing	No

# While Iterator Subsystem

---

**Purpose** Represent subsystem that executes repeatedly while condition is satisfied during simulation time step

**Library** Ports & Subsystems

**Description** The While Iterator Subsystem block is a Subsystem block that is preconfigured to serve as a starting point for creating a subsystem that executes repeatedly while a condition is satisfied during a simulation time step. See the While Iterator block and “Modeling Control Flow Logic” for more information.

```
> In1
  while ( ... out1 >
> It
```

# Width

---

**Purpose** Output width of input vector

**Library** Signal Attributes

**Description** The Width block generates as output the width of its input vector.

**Data Type Support** The Width block accepts real or complex signals of any data type supported by Simulink, including fixed-point data types. The Width block supports mixed-type signal vectors.

For a discussion on the data types supported by Simulink, see “Data Types Supported by Simulink” in the Simulink documentation.

## Parameters and Dialog Box

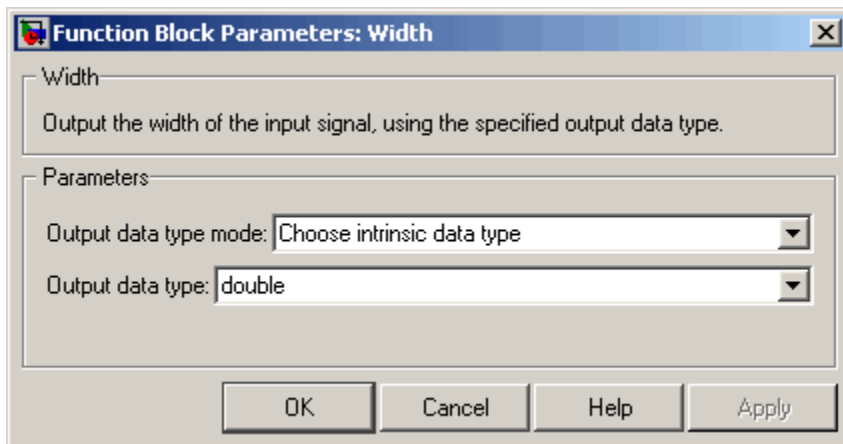

---

**Note** The Width block ignores the **Data type override** setting of the Fixed-Point Tool.

---

### Output data type mode

Specify the output data type to be the same as the input, or inherit the data type by backpropagation. You can also choose to specify



a built-in data type from the drop-down list in the **Output data type** parameter.

### **Output data type**

This parameter is visible when Choose intrinsic data type is selected from the **Output data type mode** parameter. Choose a built in data type from the drop down list.

### **Characteristics**

Sample Time	Constant
Dimensionalized	Yes
Multidimensionalized	Yes

# Wrap To Zero

**Purpose** Set output to zero if input is above threshold

**Library** Discontinuities

**Description** The Wrap To Zero block sets the output to zero if the input is above the value set by the **Threshold** parameter, and outputs the input if the input is less than or equal to the **Threshold**.

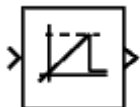

**Data Type Support** The Wrap To Zero block accepts signals of any data type supported by Simulink, including fixed-point data types.

## Parameters and Dialog Box

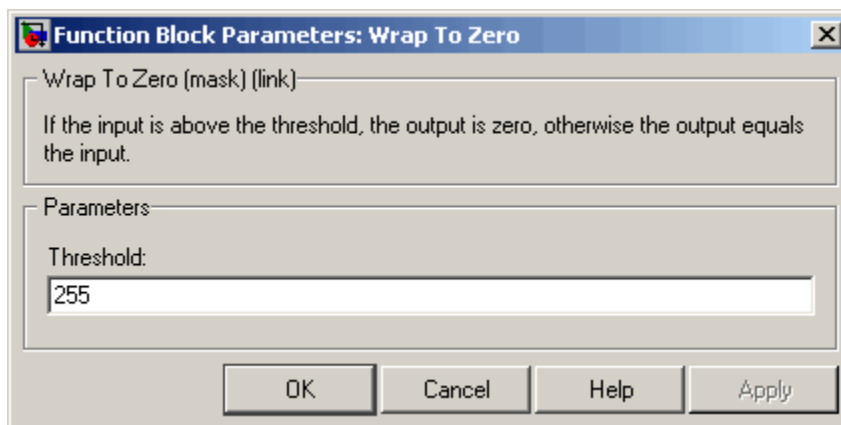

### Threshold

When the input exceeds the threshold, the output is set to zero.

<b>Characteristics</b>	Direct Feedthrough	Yes
	Scalar Expansion	Yes

**Purpose** Display X-Y plot of signals using MATLAB figure window

**Library** Sinks

## Description



The XY Graph block displays an X-Y plot of its inputs in a MATLAB figure window.

The block has two scalar inputs. The block plots data in the first input (the  $x$  direction) against data in the second input (the  $y$  direction). (See “Changing the Orientation of a Block” in *Using Simulink* for a description of the port order for various block orientations.) This block is useful for examining limit cycles and other two-state data. Data outside the specified range is not displayed.

Simulink opens a figure window for each XY Graph block in the model at the start of the simulation.

## Data Type Support

The XY Graph block accepts real signals of type double.

# XY Graph

## Parameters and Dialog Box

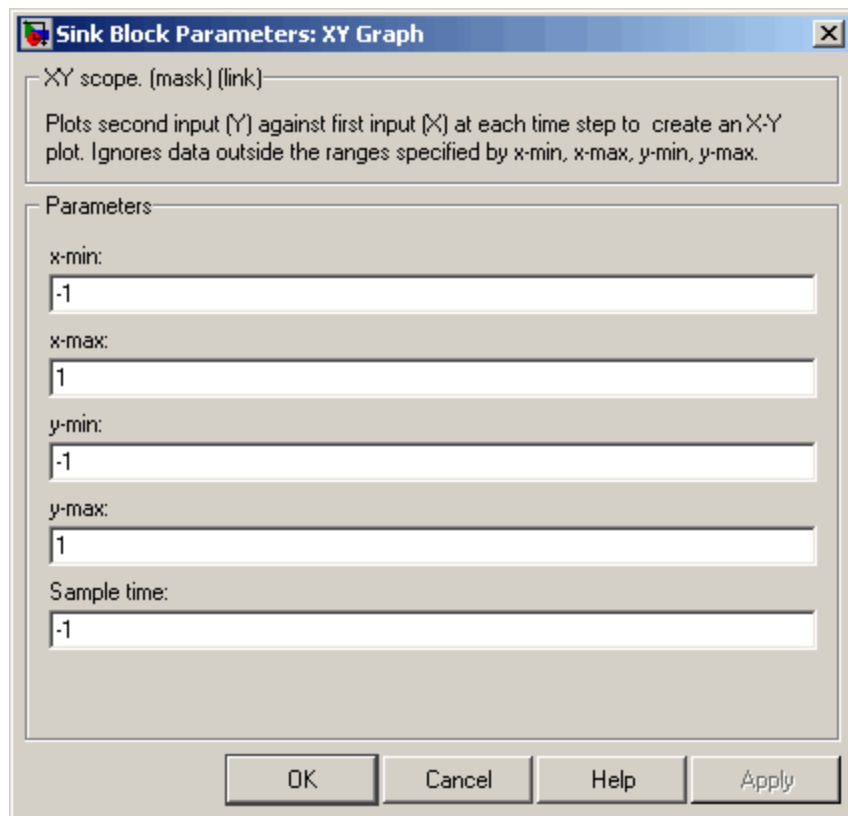

### **x-min**

The minimum  $x$ -axis value. The default is - 1.

### **x-max**

The maximum  $x$ -axis value. The default is 1.

### **y-min**

The minimum  $y$ -axis value. The default is - 1.

### **y-max**

The maximum  $y$ -axis value. The default is 1.

**Sample time**

Specify the time interval between samples. To inherit the sample time, set this parameter to -1. See “Specifying Sample Time” in the Simulink documentation for more information.

# XY Graph

## Examples

The following model computes the points that define a circle of radius 4, centered at the origin of the  $x$ - $y$  plane. The XY Graph block displays the circle.

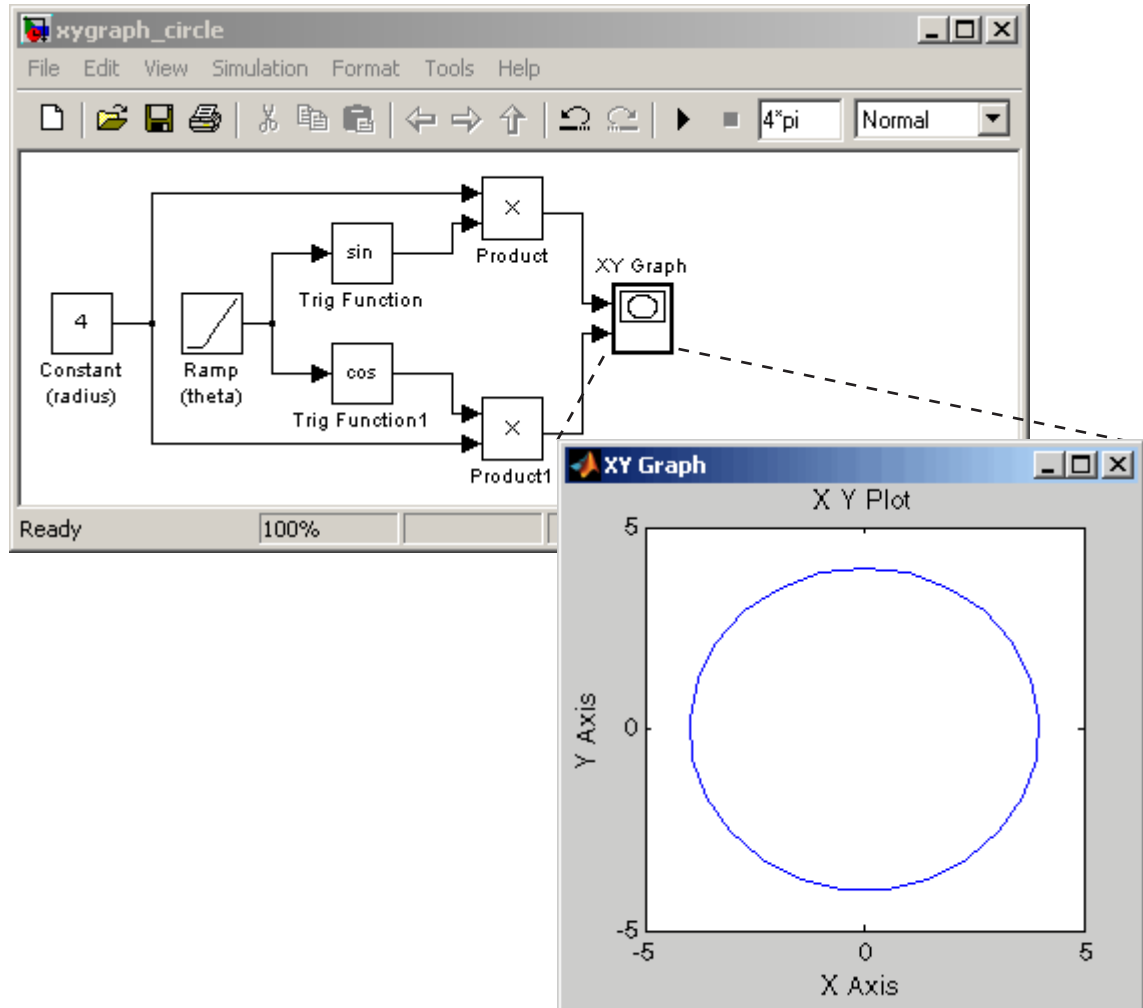

## Characteristics

Sample Time	Specified in the <b>Sample time</b> parameter
States	0

# Zero-Order Hold

---

**Purpose** Implement zero-order hold of one sample period

**Library** Discrete

**Description**

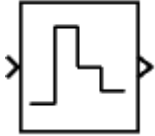

The Zero-Order Hold block samples and holds its input for the specified sample period. The block accepts one input and generates one output, both of which can be scalar or vector. If the input is a vector, all elements of the vector are held for the same sample period.

You specify the time between samples with the **Sample time** parameter. A setting of -1 means the **Sample time** is inherited.

This block provides a mechanism for discretizing one or more signals in time.

---

**Note** Do not use the Zero-Order Hold block to create a fast-to-slow transition between blocks operating at different sample rates. Instead, use the Rate Transition block.

---

**Data Type Support**

The Zero-Order Hold block accepts real or complex signals of any data type supported by Simulink, including fixed-point data types.

For a discussion on the data types supported by Simulink, see “Data Types Supported by Simulink” in the Simulink documentation.



## Parameters and Dialog Box

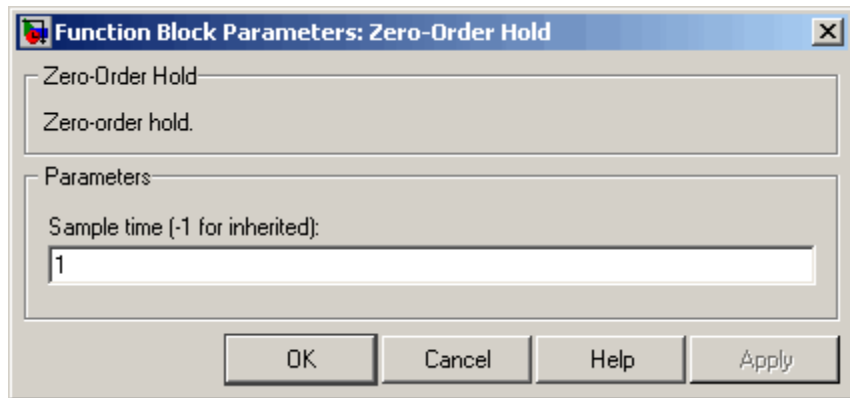

### Sample time (-1 for inherited)

Specify the time interval between samples. To inherit the sample time, set this parameter to -1. See “Specifying Sample Time” in the online documentation for more information.

## Bus Support

The Zero-Order Hold block is a bus-capable block. The input can be a virtual or nonvirtual bus signal. No block-specific restrictions exist.

- 

## Characteristics

Bus-capable	Yes
Direct Feedthrough	Yes
Sample Time	Specified in the <b>Sample time</b> parameter
Scalar Expansion	No
Dimensionalized	Yes
Zero Crossing	No

# Zero-Pole

**Purpose** Model system by zero-pole-gain transfer function

**Library** Continuous

## Description

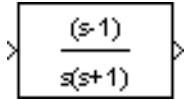

The Zero-Pole block models a system specified by the zeros, poles, and gain of a Laplace-domain transfer function that defines the relationship between the system's input and its outputs. You can use this block to model either a single-input-single output (SISO) or a single-input-multiple-output (SIMO) system.

Use the **Zeros**, **Poles**, and **Gain** parameters on the block's parameter dialog box to enter the values of the transfer function's zeros, poles, and gain, respectively. The dialog box assumes the following form for the transfer function that models the system

$$H(s) = K \frac{Z(s)}{P(s)} = K \frac{(s - Z(1))(s - Z(2)) \dots (s - Z(m))}{(s - P(1))(s - P(2)) \dots (s - P(n))}$$

where  $Z$  represents the zeros,  $P$  the poles, and  $K$  the gain of the transfer function. The number of poles must be greater than or equal to the number of zeros. If the poles and zeros are complex, they must be complex conjugate pairs.

For a single-output system,  $Z$  and  $P$  are vectors and  $K$  is a scalar. The input and the output of the block are time-domain scalar signals. For a multiple output system,  $Z$  is a matrix each of whose columns represents the zeros of a transfer function relating the system's input to one of its outputs. All of the system's transfer functions are assumed to have the same poles represented by the vector  $P$ .  $K$  is a vector each of whose elements represents a gain of the corresponding transfer function defined by  $Z$ . In this case, the output of the block is a vector each of whose elements represents the output of the transfer function defined by the corresponding column of  $Z$ , i.e., the block's output is a vector whose width is equal to the number of columns in  $Z$ .

---

**Note** You cannot use a single Zero-Pole block to model multiple-output systems whose transfer functions have a differing number of zeros or a single zero each. Use multiple Zero-Pole blocks to model such systems.

---

### Transfer Function Display on Block

The Zero-Pole block displays the transfer function depending on how the parameters are specified:

- If each is specified as an expression or a vector, the icon shows the transfer function with the specified zeros, poles, and gain. If you specify a variable in parentheses, the variable is evaluated.

For example, if you specify **Zeros** as [3,2,1], **Poles** as (poles), where poles is defined in the workspace as [7,5,3,1], and **Gain** as gain, the icon looks like this:

$$\frac{\text{gain}(s-3)(s-2)(s-1)}{(s-7)(s-5)(s-3)(s-1)}$$

- If each is specified as a variable, the icon shows the variable name followed by (s) if appropriate. For example, if you specify **Zeros** as zeros, **Poles** as poles, and **Gain** as gain, the icon looks like this.

$$\frac{\text{gain}^*\text{zeros}(s)}{\text{poles}(s)}$$

### Specifying the Absolute Tolerance for the Block's States

By default, Simulink uses the absolute tolerance value specified in the **Configuration Parameters** dialog box (see “Specifying Variable-Step Solver Error Tolerances”) to solve the states of the Zero-Pole block. If this value does not provide sufficient error control, specify a more appropriate value in the **Absolute tolerance** field of the Zero-Pole

# Zero-Pole

block's dialog box. The value that you specify is used to solve all the block's states.

## Data Type Support

The Zero-Pole block accepts real signals of type double.

## Parameters and Dialog Box

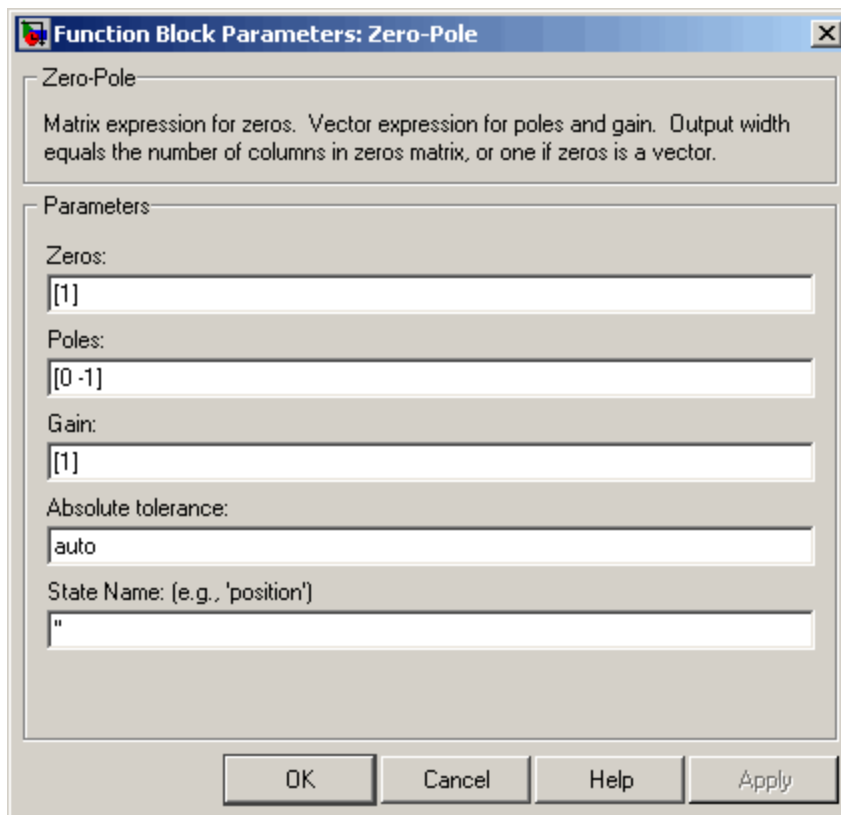

### Zeros

The matrix of zeros. The default is [1].

**Poles**

The vector of poles. The default is [0 -1].

**Gain**

The vector of gains. The default is [1].

**Absolute tolerance**

Absolute tolerance used to solve the block's states. You can enter auto or a numeric value. If you enter auto, Simulink determines the absolute tolerance (see "Specifying Variable-Step Solver Error Tolerances"). If you enter a numeric value, Simulink uses the specified value to solve the block's states. Note that a numeric value overrides the setting for the absolute tolerance in the **Configuration Parameters** dialog box.

**State Name**

Use this to assign a unique name to each state. The state names apply only to the selected block. If left blank, no name is assigned.

To assign a name to a single state, enter the name between quotes, for example, 'velocity'.

To assign names to multiple states, enter a comma-delimited list surrounded by braces. For example, {'a', 'b', 'c'}. Each name must be unique.

The number of states must be evenly divided by the number of state names. There can be fewer names than the number of states, but there cannot be more names than states.

For example, you can specify two names in a system with four states. Simulink will assign the first name to the first two states and the second name to the last two.

To assign state names with a variable that has been defined in the MATLAB workspace, enter the variable without quotes. A variable can be a string, cell, or structure.

# Zero-Pole

---

## Characteristics

Direct Feedthrough	Only if the lengths of the <b>Poles</b> and <b>Zeros</b> parameters are equal
Sample Time	Continuous
Scalar Expansion	No
States	Length of <b>Poles</b> vector
Dimensionalized	No
Zero Crossing	No

# Functions — By Category

---

Model Construction (p. 3-2)	Model construction functions
Simulation (p. 3-6)	Simulation functions
Linearization and Trimming (p. 3-7)	Linearization and trimming functions
Data Type (p. 3-8)	Data type functions

## Model Construction

<code>addterms</code>	Add terminators to unconnected ports in model
<code>add_block</code>	Add block to Simulink system
<code>add_line</code>	Add line to Simulink system
<code>add_param</code>	Add parameter to Simulink system
<code>attachConfigSet</code>	Associate configuration set or configuration reference with model
<code>attachConfigSetCopy</code>	Copy configuration set or configuration reference and associate it with model
<code>bdclose</code>	Close any or all Simulink system windows unconditionally
<code>bdroot</code>	Return name of top-level Simulink system
<code>closeDialog</code>	Close configuration parameters dialog
<code>close_system</code>	Close Simulink system window or block dialog box
<code>delete_block</code>	Delete block from Simulink system
<code>delete_line</code>	Delete line from Simulink system
<code>delete_param</code>	Delete system parameter added via <code>add_param</code> command
<code>detachConfigSet</code>	Dissociate configuration set or configuration reference from model
<code>disableimplicitsignalresolution</code>	Convert model to use only explicit signal resolution
<code>docblock</code>	Get or set editor invoked by Simulink DocBlock
<code>find_mdrefs</code>	Find Model blocks in model. Find models that Model blocks reference



<code>find_system</code>	Find systems, blocks, lines, ports, and annotations
<code>gcb</code>	Get pathname of current block
<code>gcbh</code>	Get handle of current block
<code>gcs</code>	Get pathname of current system
<code>getActiveConfigSet</code>	Get model's active configuration set or configuration reference
<code>getCallbackAnnotation</code>	Get information about annotation
<code>getConfigSet</code>	Get one of model's configuration sets or configuration references
<code>getConfigSets</code>	Get names of all of model's configuration sets or configuration references
<code>getfullname</code>	Get pathname of block or line
<code>get_param</code>	Get system and block parameter values
<code>legacy_code</code>	Use Legacy Code Tool
<code>libinfo</code>	Get information about library blocks referenced by model
<code>load_system</code>	Invisibly load Simulink model
<code>modeladvisor</code>	Open Model Advisor
<code>new_system</code>	Create empty Simulink system
<code>openDialog</code>	Open configuration parameters dialog
<code>open_system</code>	Open Simulink system window or block dialog box
<code>replace_block</code>	Replace blocks in Simulink model
<code>save_system</code>	Save Simulink system
<code>setActiveConfigSet</code>	Specifies model's active configuration set or configuration reference

<code>set_param</code>	Set Simulink system and block parameters
<code>signalbuilder</code>	Create and access Signal Builder blocks
<code>simulink</code>	Open Simulink block library
<code>Simulink.BlockDiagram.addBusToVector</code>	Add Bus to Vector blocks to convert bus signals used as muxes/vectors to vectors
<code>Simulink.BlockDiagram.copyContentsToSubSystem</code>	Copy contents of block diagram to empty subsystem
<code>Simulink.BlockDiagram.deleteContents</code>	Delete contents of block diagram
<code>Simulink.Bus.cellToObject</code>	Convert cell array containing bus information to bus objects
<code>Simulink.Bus.createObject</code>	Create bus objects for blocks
<code>Simulink.Bus.objectToCell</code>	Convert bus objects to cell array containing bus information
<code>Simulink.Bus.save</code>	Save bus objects in M-file
<code>Simulink.SubSystem.convertToModelReference</code>	Convert atomic subsystem or function call subsystem to model reference
<code>Simulink.SubSystem.copyContentsToBlockDiagram</code>	Copy contents of subsystem to empty block diagram
<code>Simulink.SubSystem.deleteContents</code>	Delete contents of subsystem
<code>slCharacterEncoding</code>	Change MATLAB character set encoding
<code>sldiscmdl</code>	Discretize Simulink model containing continuous blocks
<code>slIsFileChangedOnDisk</code>	Determine whether model has changed since it was loaded
<code>slmdliscui</code>	Open Model Discretizer GUI

---

slreplace_mux	Replace Mux blocks used to create buses with Bus Creator blocks
slupdate	Replace blocks from previous releases with latest versions
view_mdrefs	Display graph of model reference dependencies

## Simulation

<code>add_exec_event_listener</code>	Register listener for block method execution event
<code>model</code>	Execute particular phase of simulation of model
<code>sim</code>	Simulate dynamic system
<code>simget</code>	Get settings of model's simulation parameters
<code>simplot</code>	Plot simulation data in figure window
<code>simset</code>	Specify simulation options for simulations run via <code>sim</code> command
<code>Simulink.BlockDiagram.getInitialState</code>	Return initial state structure of block diagram
<code>Simulink.BlockDiagram.getChecksum</code>	Return checksum of model
<code>Simulink.SubSystem.getChecksum</code>	Return checksum of subsystem
<code>slbuild</code>	Build standalone and model reference targets
<code>sldebug</code>	Start simulation in debug mode
<code>sldiagnostics</code>	Display diagnostic information about Simulink system
<code>unpack</code>	Extract signal logging objects from signal logs and write them into MATLAB workspace
<code>who</code>	List contents of signal log
<code>whos</code>	List names and types of simulink data logging objects contained by <code>Simulink.ModelDataLogs</code> or <code>Simulink.SubsysDataLogs</code> object

## Linearization and Trimming

linmod, dlinmod, linmod2, linmodv5	Extract continuous- or discrete-time linear state-space model of system around operating point
trim	Find trim point of dynamic system

## Data Type

<code>fixdt</code>	Create <code>Simulink.NumericType</code> object describing fixed-point or floating-point data type
<code>fixptbestexp</code>	Determine exponent that gives best precision fixed-point representation of value
<code>fixptbestprec</code>	Determine maximum precision available for fixed-point representation of value
<code>fixpt_evenspace_cleanup</code>	Modify lookup table input data to be evenly spaced
<code>fixpt_interp1</code>	Implement 1-D lookup table
<code>fixpt_look1_func_approx</code>	Optimize for fixed-point function, <code>x</code> values, or breakpoints that are generated for lookup table
<code>fixpt_look1_func_plot</code>	Plot function with <code>x</code> values generated by <code>fixpt_look1_func_approx</code> function
<code>fixpt_set_all</code>	Set property for every fixed-point block in subsystem
<code>float</code>	Create MATLAB structure describing floating-point data type
<code>fxptdlg</code>	Invoke Fixed-Point Tool
<code>num2fixpt</code>	Convert number to nearest value representable by specified fixed-point data type
<code>sfix</code>	Create MATLAB structure describing signed generalized fixed-point data type

---

sfrac	Create MATLAB structure describing signed fractional data type
sint	Create MATLAB structure describing signed integer data type
tunablevars2parameterobjects	Create Simulink parameter objects from tunable parameters
ufix	Create MATLAB structure describing unsigned generalized fixed-point data type
ufrac	Create MATLAB structure describing unsigned fractional data type
uint	Create MATLAB structure describing unsigned integer data type





# Functions — Alphabetical List

---

# add\_block

---

## Purpose

Add block to Simulink system

## Syntax

```
add_block('src', 'dest')
add_block('src', 'dest', 'param1', value1, ...)
add_block('src', 'dest', 'MakeNameUnique', 'on', 'param1',
value1,...)
add_block('src_inport', 'dest_inport', 'copyoption', 'duplicate',
'param1', value1,...)
```

## Description

`add_block('src', 'dest')` copies the block with the full pathname '*src*' to a new block with the full pathname '*dest*'. The block parameters of the new block are identical to those of the original. You can use '*built-in/blocktype*' as a source block path for Simulink built-in blocks (blocks available in Simulink block libraries that are not masked blocks), where *blocktype* is the built-in block's type, i.e., the value of its BlockType parameter (see "Common Block Parameters" on page 8-66).

`add_block('src', 'dest', 'param1', value1, ...)` creates a copy as above, in which the named parameters have the specified values. Any additional arguments must occur in parameter/value pairs.

`add_block('src', 'dest', 'MakeNameUnique', 'on', 'parameter1', value1,...)` creates a copy of *src*. If a block having the full pathname '*dest*' already exists, the command creates a unique name for the new block based on '*dest*'.

`add_block('src_inport', 'dest_inport', 'copyoption', 'duplicate', 'param1', value1,...)` applies only to Inport blocks. It creates a copy with the same port number as the '*src\_inport*' block.

Before you add a block, you need to first open the library that contains the block with the `load_system` (library opens invisibly) or `open_system` (library opens visibly) command.

## Examples

This command copies the Scope block from the Sinks subsystem of the simulink system to a block named Scope1 in the timing subsystem of the engine system.

```
add_block('simulink/Sinks/Scope', 'engine/timing/Scope1')
```

This command creates a new subsystem named controller in the F14 system.

```
add_block('built-in/SubSystem', 'F14/controller')
```

This command copies the built-in Gain block to a block named Volume in the mymodel system and assigns the Gain parameter a value of 4.

```
add_block('built-in/Gain', 'mymodel/Volume', 'Gain', '4')
```

The following command

```
block = add_block('vdp/Mu', 'vdp/Mu', 'MakeNameUnique', 'on')
```

copies the block named Mu in vdp and create a copy. Since Mu already exists, the command names the new block Mu1.

## See Also

`delete_block`, `set_param`

# add\_exec\_event\_listener

---

**Purpose** Register listener for block method execution event

**Syntax** `h = add_exec_event_listener(blk, event, listener);`

**Description** `h = add_exec_event_listener(blk, event, listener)` registers a listener for a block method execution event where the listener is an M-file program that performs some task, such as logging runtime data for a block, when the event occurs (see “Listening for Method Execution Events” in *Using Simulink* for more information). Simulink invokes the registered listener whenever the specified event occurs during simulation of the model.

---

**Note** Simulink can register a listener only while a simulation is running. Invoking this function when no simulation is running results in an error message. To ensure that a listener catches all relevant events triggered by a model’s simulation, you should register the listener in the model’s StartFcn callback function (see “Model Callback Functions”).

---

## Arguments

`blk`

Specifies the block whose method execution event the listener is intended to handle. May be one of the following:

- Full pathname of a block
- A block handle
- A block runtime object (see “Accessing Block Data During Simulation” in *Using Simulink*.)

`event`

Specifies the type of event for which the listener listens. It may be any of the following:

Event	Occurs...
'PreDerivatives'	Before a block's Derivatives method executes
'PostDerivatives'	After a block's Derivatives method executes
'PreOutputs'	Before a block's Outputs method executes.
'PostOutputs'	After a block's Outputs method executes
'PreUpdate'	Before a block's Update method executes
'PostUpdate'	After a block's Update method executes

## listener

Specifies the listener to be registered. It may be either a string specifying a MATLAB expression, e.g., `'disp(''here'')` or a handle to a MATLAB function that accepts two arguments. The first argument is the block runtime object of the block that triggered the event. The second argument is an instance of `EventData` class that specifies the runtime object and the name of the event that just occurred.

## Return Value

`add_exec_event_listener` returns a handle to the listener that it registered. To stop listening for an event, use the MATLAB `clear` command to clear the listener handle from the workspace in which the listener was registered.

# add\_line

---

**Purpose** Add line to Simulink system

**Syntax**

```
h = add_line('sys','oport','iport')
h = add_line('sys','oport','iport', 'autorouting','on')
h = add_line('sys', points)
```

**Description** The `add_line` command adds a line to the specified system and returns a handle to the new line. You can define the line in two ways:

- By naming the block ports that are to be connected by the line
- By specifying the location of the points that define the line segments

`add_line('sys', 'oport', 'iport')` adds a straight line to a system from the specified block output port `'oport'` to the specified block input port `'iport'`. `'oport'` and `'iport'` are strings consisting of a block name and a port identifier in the form `'block/port'`. Most block ports are identified by numbering the ports from top to bottom or from left to right, such as `'Gain/1'` or `'Sum/2'`. Enable, Trigger, State, and Action ports are identified by name, such as `'subsystem_name/Enable'`, `'subsystem_name/Trigger'`, `'Integrator/State'`, or `if_action_subsystem_name/Ifaction'`.

`add_line('sys','oport','iport', 'autorouting','on')` works like `add_line('sys','oport','iport')` except that it routes the line around intervening blocks. The default value for `autorouting` is `'off'`.

`add_line(system, points)` adds a segmented line to a system. Each row of the `points` array specifies the  $x$  and  $y$  coordinates of a point on a line segment. The origin is the top-left corner of the window. The signal flows from the point defined in the first row to the point defined in the last row. If the start of the new line is close to the output of an existing block or line, a connection is made. Likewise, if the end of the line is close to an existing input, a connection is made.

## Examples

This command adds a line to the `mymodel` system connecting the output of the Sine Wave block to the first input of the Mux block.

```
add_line('mymodel','Sine Wave/1','Mux/1')
```

This command adds a line to the `mymodel` system extending from (20,55) to (40,10) to (60,60).

```
add_line('mymodel',[20 55; 40 10; 60 60])
```

## See Also

`delete_line`

# add\_param

---

**Purpose** Add parameter to Simulink system

**Syntax** `add_param('sys','parameter1',value1,'parameter2',value2,...)`

**Description** The `add_param` command adds the specified parameters to the specified system and initializes the parameters to the specified values. Case is ignored for parameter names. Value strings are case sensitive. The value of the parameter must be a string. Once the parameter is added to a system, `set_param` and `get_param` can be used on the new parameters as if they were standard Simulink parameters. Simulink saves these new parameters with the model file.

---

**Note** If you attempt to add a parameter that has the same name as an existing parameter of the system, Simulink displays an error.

---

**Examples** This command

```
add_param('vdp','DemoName','VanDerPolEquation','EquationOrder','2')
```

adds the parameters `DemoName` and `EquationOrder` with string values `'VanDerPolEquation'` and `'2'` to the `vdp` system. Afterward, you can use the following command to retrieve the value of the `DemoName` parameter.

```
get_param('vdp','DemoName')
```

**See Also** `delete_param`, `get_param`, `set_param`



**Purpose** Add terminators to unconnected ports in model

**Syntax** `addterms('sys')`

**Description** `addterms('sys')` adds Terminator and Ground blocks to the unconnected ports in the Simulink block diagram `sys`.

**See Also** `slupdate`

# attachConfigSet

---

**Purpose** Associate configuration set or configuration reference with model

**Syntax**  
`attachConfigSet('model', configObj)`  
`attachConfigSet('model', configObj, allowRename)`

**Arguments**

*model*  
The name of an open model, or gcs to specify the current model

*configObj*  
A configuration set (`Simulink.ConfigSet`) or configuration reference (`Simulink.ConfigSetRef`)

*allowRename*  
Boolean that determines how Simulink handles a name conflict

**Description** `attachConfigSet` associates the configuration set or configuration reference (configuration object) specified by *configObj* with *model*.

You cannot attach a configuration object to a model if the configuration object is already attached to another model, or has the same name as another configuration object attached to the same model. The optional Boolean argument *allowRename* determines how Simulink handles a name conflict between configuration objects. If *allowRename* is false and the configuration object specified by *configObj* has the same name as a configuration object already attached to *model*, Simulink generates an error. If *allowRename* is true and a name conflict occurs, Simulink provides a unique name for *configObj* before associating *configObj* with *model*.

**Example** The following example creates a copy of the current model's active configuration object and attaches it to the model, changing its name if necessary to be unique. The code is the same whether the object is a configuration set or configuration reference.

```
myConfigObj = getActiveConfigSet(gcs);
copiedConfig = myConfigObj.copy;
copiedConfig.Name = 'DevConfig';
attachConfigSet(gcs, copiedConfig, true);
```

## See Also

“Configuration Sets”, “Referencing Configuration Sets”

`attachConfigSetCopy`, `closeDialog`, `detachConfigSet`,  
`getActiveConfigSet`, `getConfigSet`, `getConfigSets`, `openDialog`,  
`setActiveConfigSet`

# attachConfigSetCopy

---

**Purpose** Copy configuration set or configuration reference and associate it with model

**Syntax**  
`myConfigObj = attachConfigSetCopy('model', configObj)`  
`myConfigObj = attachConfigSetCopy('model', configObj, allowRename)`

**Arguments**

*model*  
The name of an open model, or gcs to specify the current model

*configObj*  
A configuration set (Simulink.ConfigSet) or configuration reference (Simulink.ConfigSetRef)

*allowRename*  
Boolean that specifies how Simulink handles a name conflict

**Description** attachConfigSetCopy copies the configuration set or configuration reference (configuration object) specified by *configObj* and associates the copy with *model*. Simulink returns the copied configuration object as *newConfigObj*.

You cannot attach a configuration object to a model if the configuration object has the same name as another configuration object attached to the same model. The optional Boolean argument *allowRename* determines how Simulink handles a name conflict between configuration objects. If *allowRename* is false and the configuration object specified by *configObj* has the same name as a configuration object already attached to *model*, Simulink generates an error. If *allowRename* is true and a name conflict occurs, Simulink provides a unique name for the copy of *configObj* before associating it with *model*.

**Example** The following example creates a copy of ModelA's active configuration object and attaches it to ModelB, changing the name if necessary to be unique. The code is the same whether the object is a configuration set or configuration reference.

```
myConfigObj = getActiveConfigSet('ModelA');
```

```
newConfigObj = attachConfigSetCopy('ModelB', myConfigObj, true);
```

## See Also

“Configuration Sets”, “Referencing Configuration Sets”

attachConfigSet, closeDialog, detachConfigSet,  
getActiveConfigSet, getConfigSet, getConfigSets,  
openDialog, setActiveConfigSet

# bdclose

---

<b>Purpose</b>	Close any or all Simulink system windows unconditionally
<b>Syntax</b>	<code>bdclose</code> <code>bdclose('sys')</code> <code>bdclose('all')</code>
<b>Description</b>	<p><code>bdclose</code> with no arguments closes the current system window unconditionally and without confirmation. Any changes made to the system since it was last saved are lost.</p> <p><code>bdclose('sys')</code> closes the specified system window.</p> <p><code>bdclose('all')</code> closes all system windows.</p>
<b>Examples</b>	<p>This command closes the vdp system.</p> <pre>bdclose('vdp')</pre>
<b>See Also</b>	<code>close_system</code> , <code>new_system</code> , <code>open_system</code> , <code>save_system</code>

<b>Purpose</b>	Return name of top-level Simulink system
<b>Syntax</b>	<code>bdroot</code> <code>bdroot('obj')</code>
<b>Description</b>	<code>bdroot</code> with no arguments returns the top-level system name. <code>bdroot('obj')</code> , where 'obj' is a system or block pathname, returns the name of the top-level system containing the specified object name.
<b>Examples</b>	This command returns the name of the top-level system that contains the current block.  <code>bdroot(gcb)</code>
<b>See Also</b>	<code>find_system</code> , <code>gcb</code>

# close\_system

---

**Purpose** Close Simulink system window or block dialog box

**Syntax**

```
close_system
close_system('sys')
close_system('sys', saveflag)
close_system('sys', 'newname')
close_system('sys', 'newname', 'ErrorIfShadowed', true)
```

**Description** `close_system` with no arguments closes the current system or subsystem window. If the current system is the top-level system and it has been modified, `close_system` returns an error. The current system is defined in the description of the `gcs` command.

`close_system('sys')` closes the specified system, subsystem, or block window.

'*sys*' can be a string (which can be a system, a subsystem, or a full block pathname), a cell array of strings, a numeric handle, or an array of numeric handles. This command displays an error if '*sys*' is a MATLAB keyword, 'simulink', or more than 63 characters long.

`close_system('sys', saveflag)`, if *saveflag* is 1, saves the specified top-level system to a file with its current name, then closes the specified top-level system window and removes it from memory. If *saveflag* is 0, the system is closed without saving. A single *saveflag* can be supplied, in which case it is applied to all block diagrams. Alternatively, separate *saveflags* can be supplied for each block diagram, as a numeric array.

`close_system('sys', 'newname')` saves the specified top-level system to a file with the specified new name, then closes the system.

Additional arguments can be supplied when saving a block diagram. These are exactly the same as for `save_system`:

- `ErrorIfShadowed`: true or false (default: false)
- `BreakLinks`: true or false (default: false)
- `SaveAsVersion`: MATLAB version name (default: current)



- `OverwriteIfChangedOnDisk`: true or false (default: false)
- `SaveModelWorkspace`: true or false (default: false)

If you try to specify additional options when you are doing something other than saving a block diagram, they are ignored. You see a warning if you try to save when closing something other than a block diagram (e.g., a subsystem or a Block Properties dialog).

## Examples

This command closes the current system.

```
close_system
```

This command closes the `vdp` system, unless it has been modified, in which case it returns an error.

```
close_system('vdp')
```

This command saves the engine system with its current name, then closes it.

```
close_system('engine', 1)
```

This command saves the `mymdl12` system under the new name `testsys`, then closes it.

```
close_system('mymdl12', 'testsys')
```

This command tries to save the `vdp` system to a file with the name `'max'`, but returns an error because `'max'` is the name of an existing MATLAB function.

```
close_system('vdp','max','ErrorIfShadowed', true)
```

All three of the following commands save and close `mymodel` (saved with the same name), and replace links to library blocks with copies of the library blocks in the saved file:

```
close_system('mymodel',1,'BreakLinks',true)
```

# close\_system

---

```
close_system('mymodel','mymodel','BreakLinks',true)
close_system('mymodel',[],'BreakLinks',true)
```

This command closes the dialog box of the Unit Delay block in the Combustion subsystem of the engine system.

```
close_system('engine/Combustion/Unit Delay')
```

---

**Note** The `close_system` command cannot be used in a block or menu callback to close the root-level model. Attempting to close the root-level model in a block or menu callback results in an error and discontinues the callback's execution.

---

## See Also

`bdclose`, `gcs`, `new_system`, `open_system`, `save_system`

<b>Purpose</b>	Close configuration parameters dialog
<b>Syntax</b>	<code>closeDialog(<i>configObj</i>)</code>
<b>Arguments</b>	<i>configObj</i> A configuration set (Simulink.ConfigSet) or configuration reference (Simulink.ConfigSetRef)
<b>Description</b>	<code>closeDialog</code> closes an open configuration parameters dialog box. If <i>configObj</i> is a configuration set, the function closes the dialog box that displays the configuration set. If <i>configObj</i> is a configuration reference, the function closes the dialog box that displays the referenced configuration set, or generates an error if the reference does not specify a valid configuration set. If the dialog box is already closed, the function does nothing.
<b>Example</b>	<p>The following example closes a configuration parameters dialog box that shows the current parameters for the current model. The parameter values derive from the active configuration set or configuration reference (configuration object). The code is the same in either case; the only difference is which type of configuration object is currently active.</p> <pre>myConfigObj = getActiveConfigSet(gcs); closeDialog(myConfigObj);</pre>
<b>See Also</b>	“Configuration Sets”, “Referencing Configuration Sets” <code>attachConfigSet</code> , <code>attachConfigSetCopy</code> , <code>detachConfigSet</code> , <code>getActiveConfigSet</code> , <code>getConfigSet</code> , <code>getConfigSets</code> , <code>openDialog</code> , <code>setActiveConfigSet</code>

# delete\_block

---

**Purpose** Delete block from Simulink system

**Syntax** `delete_block('blk')`

**Description** `delete_block('blk')`, where 'blk' is a full block pathname, deletes the specified block from a system.

**Examples** This command removes the Out1 block from the vdp system.

```
delete_block('vdp/Out1')
```

**See Also** `add_block`

**Purpose** Delete line from Simulink system

**Syntax**

```
delete_line('sys', 'oport', 'iport')
delete_line('system', [x y])
delete_line('handle')
```

**Description**

`delete_line('sys', 'oport', 'iport')` deletes the line extending from the specified block output port 'oport' to the specified block input port 'iport'. 'oport' and 'iport' are strings consisting of a block name and a port identifier in the form 'block/port'. Most block ports are identified by numbering the ports from top to bottom or from left to right, such as 'Gain/1' or 'Sum/2'. Enable, Trigger, and State ports are identified by name, such as 'subsystem\_name/Enable', 'subsystem\_name/Trigger', 'Integrator/State', or 'if\_action\_subsystem\_name/Ifaction'.

`delete_line('sys', [x y])` deletes one of the lines in the system that contains the specified point (x,y), if any such line exists.

`delete_line('system', [x y])` deletes all of the lines in the system that contain the specified point, including any branches.

`delete_line('handle')` deletes the line specified by the handle, 'handle'.

**Examples**

This command removes the line from the `mymodel` system connecting the Sum block to the second input of the Mux block.

```
delete_line('mymodel', 'Sum/1', 'Mux/2')
```

**See Also** `add_line`

# delete\_param

---

**Purpose** Delete system parameter added via add\_param command

**Syntax** delete\_param('sys', 'parameter1', 'parameter2', ...)

**Description** This command deletes parameters that were added to the system using the add\_param command. The command displays an error message if a specified parameter was not added with the add\_param command.

**Examples** The following example

```
add_param('vdp', 'DemoName', 'VanDerPolEquation', 'EquationOrder', '2')
delete_param('vdp', 'DemoName')
```

adds the parameters DemoName and EquationOrder to the vdp system, then deletes DemoName from the system.

**See Also** add\_param

<b>Purpose</b>	Dissociate configuration set or configuration reference from model
<b>Syntax</b>	<code>detachConfigSet('model', 'configObjName')</code>
<b>Arguments</b>	<p><i>model</i> The name of an open model, or gcs to specify the current model</p> <p><i>configObjName</i> The name of a configuration set (Simulink.ConfigSet) or configuration reference (Simulink.ConfigSetRef)</p>
<b>Description</b>	<code>detachConfigSet</code> detaches the configuration set or configuration reference (configuration object) specified by ' <i>configObjName</i> ' from <i>model</i> . If no such configuration object is attached to the model, an error occurs.
<b>Examples</b>	<p>The following example detaches the configuration object named DevConfig from the current model. The code is the same whether DevConfig is a configuration set or configuration reference.</p> <pre>detachConfigSet(gcs, 'DevConfig');</pre>
<b>See Also</b>	<p>“Configuration Sets”, “Referencing Configuration Sets”</p> <p><code>attachConfigSet</code>, <code>attachConfigSetCopy</code>, <code>closeDialog</code>, <code>getActiveConfigSet</code>, <code>getConfigSet</code>, <code>getConfigSets</code>, <code>openDialog</code>, <code>setActiveConfigSet</code></p>

# disableimplicitsignalresolution

---

**Purpose** Convert model to use only explicit signal resolution

**Syntax**  
`[retVal] = disableimplicitsignalresolution(model)`  
`[retVal] = disableimplicitsignalresolution(model, displayOnly)`

**Arguments**

*model*  
Model name or handle.

*displayOnly*  
Boolean specifying whether to change the model or just generate a report. Default: false; the function changes the model.

**Return**

*retVal*  
A MATLAB structure containing:

- **Signals:** Handles to ports with signal names that resolve to signal objects
- **States:** Handles to blocks with states that resolve to signal objects.

**Description**

`disableimplicitsignalresolution` inputs a model, reports all signals and states that implicitly resolve to signal objects, and optionally converts the model to resolve only signals and states that explicitly require it. The report and any changes are limited to the model itself; they do not include blocks that are library links. Before executing this function, ensure that all relevant Simulink data objects are defined in the base workspace. The function ignores any data objects that are defined elsewhere.

If *displayOnly* is true, the function scans *model*, returns a structure of handles to signals and states that resolve implicitly to signal objects, and leaves the model unchanged. If *displayOnly* is false (the default), the function returns the same list and also performs the following operations on *model*:



- Search the model for all output ports and block states that resolve to Simulink signal objects.
- Modify these ports and blocks to enforce signal object resolution in the future.
- Set the model's `SignalResolutionControl` parameter to 'UseLocalSettings' (GUI: **Explicit Only**).
- If any Stateflow output data resolves to a Simulink signal object:
  - Turn off hierarchical scoping of signal objects from within the Stateflow chart.
  - Explicitly label the output signal of the Stateflow chart.
  - Enforce signal object resolution for this signal in the future.

---

**Note** The changes made by `disableimplicitsignalresolution` permanently change the model. Be sure to back up the model before calling the function with `displayOnly` defaulted or specified as `false`.

---

## See Also

“Signal Properties Dialog Box”

“Data Validity Diagnostics Overview”

`Simulink.Signal`

**Purpose** Get or set editor invoked by Simulink DocBlock

**Syntax**

```
docblock('setEditorHTML', editCmd)
docblock('setEditorDOC', editCmd)
docblock('setEditorTXT', editCmd)
editCmd = docblock('getEditorHTML')
editCmd = docblock('getEditorDOC')
editCmd = docblock('getEditorTXT')
```

**Description** `docblock('setEditorHTML', editCmd)` sets the HTML editor invoked by the DocBlock. The *editCmd* string specifies a command, executed at the MATLAB prompt, which launches a custom HTML editor. By default, the DocBlock invokes Microsoft Word (if available) as the HTML editor; otherwise, it opens HTML documents using the editor you specified on the **Editor/Debugger Preferences** pane of the Preferences dialog box.

`docblock('setEditorDOC', editCmd)` sets the Rich Text Format (RTF) editor invoked by the DocBlock. The *editCmd* string specifies a command, executed at the MATLAB prompt, which launches a custom RTF editor. By default, the DocBlock invokes Microsoft Word (if available) as the RTF editor; otherwise, it opens RTF documents using the editor you specified on the **Editor/Debugger Preferences** pane of the Preferences dialog box.

`docblock('setEditorTXT', editCmd)` sets the text editor invoked by the DocBlock. The *editCmd* string specifies a command, executed at the MATLAB prompt, which launches a custom text editor. By default, the DocBlock invokes the editor you specified on the **Editor/Debugger Preferences** pane of the Preferences dialog box.

`editCmd = docblock('getEditorHTML')` returns the value of the current command used to invoke an HTML editor when double-clicking the DocBlock.

`editCmd = docblock('getEditorDOC')` returns the value of the current command used to invoke a RTF editor when double-clicking the DocBlock.

`editCmd = docblock('getEditorTXT')` returns the value of the current command used to invoke a text editor when double-clicking the DocBlock.

---

**Note** Use the "%<FileName>" token in the *editCmd* string to represent the full pathname to the document. Use the empty string '' as the *editCmd* to reset the DocBlock to its default editor for a particular document type.

---

## Examples

This command specifies Microsoft Notepad as the DocBlock editor for RTF documents.

```
docblock('setEditorRTF','system(''notepad "%<FileName>"');')
```

This command resets the DocBlock to use its default editor for RTF documents.

```
docblock('setEditorRTF','')
```

This command specifies Mozilla Composer as the HTML editor for the DocBlock.

```
docblock('setEditorHTML','system(''/usr/local/bin/mozilla ...  
-edit "%<FileName>" &'');')
```

# find\_mdrefs

---

**Purpose** Find Model blocks in model. Find models that Model blocks reference

**Syntax**

```
[refMdlS, mdlBlks] = find_mdrefs('modelName')  
[refMdlS, mdlBlks] = find_mdrefs('modelName', true)  
[refMdlS, mdlBlks] = find_mdrefs('modelName', false)
```

**Description** [refMdlS, mdlBlks] = find\_mdrefs('modelName') or find\_mdrefs('modelName', true) finds all Model blocks contained by and models referenced by 'modelName' directly or indirectly (i.e., via models referenced by 'modelName'). The commands output arguments are

- refMdlS  
List of models. The last element in the list is 'modelName'. The other elements are the names of models referenced by 'modelName'.
- mdlBlks  
Names of Model blocks contained by 'modelName' and the models that it references directly or indirectly.

[refMdlS, mdlBlks] = find\_mdrefs(modelName, false) finds only the Model blocks and models directly referenced by 'modelName'.

**Examples** Open the sldemo\_mdref\_basic demo. Then execute

```
>> [r, b] = find_mdrefs('sldemo_mdref_basic')  
  
r =  
    'sldemo_mdref_counter'  
    'sldemo_mdref_basic'  
  
b =  
    'sldemo_mdref_basic/CounterA'  
    'sldemo_mdref_basic/CounterB'  
    'sldemo_mdref_basic/CounterC'
```

**See Also**      `view_mdrefs`

# find\_system

---

**Purpose** Find systems, blocks, lines, ports, and annotations

**Syntax** `find_system(sys, 'c1', cv1, 'c2', cv2,...'p1', v1, 'p2', v2,...)`

**Description** `find_system(sys, 'c1', cv1, 'c2', cv2,...'p1', v1, 'p2', v2,...)` searches the systems or subsystems specified by `sys`, using the constraints specified by `c1`, `c2`, etc., and returns handles or paths to the objects whose parameters, `p1`, `p2`, etc., have the values, `v1`, `v2`, etc. `sys` can be a pathname (or cell array of pathnames), a handle (or vector of handles), or omitted. If you specify 'BlockDialogParams' as the parameter name, `find_system` searches for all blocks that have a parameter that has the specified value and appears in the block's dialog box.

---

**Note** All the search constraints must precede all the property-value pairs in the argument list.

---

If `sys` is a pathname or cell array of pathnames, `find_system` returns a cell array of pathnames of the objects it finds. If `sys` is a handle or a vector of handles, `find_system` returns a vector of handles to the objects that it finds. If `sys` is omitted, `find_system` searches all open systems and returns a cell array of pathnames.

Case is ignored for parameter names. Value strings are case sensitive by default (see the 'CaseSensitive' search constraint for more information). Any parameters that correspond to dialog box entries have string values. See Chapter 8, "Model and Block Parameters" for a list of model and block parameters.

You can specify any of the following search constraints.

Name	Value Type	Description
'SearchDepth'	scalar	Restricts the search depth to the specified level (0 for open systems only, 1 for blocks and subsystems of the top-level system, 2 for the top-level system and its children, etc.). The default is all levels.
'LookUnderMasks'	'none'	Search skips masked blocks.
	{'graphical'}	Search includes masked blocks that have no workspaces and no dialogs. This is the default.
	'functional'	Search includes masked blocks that do not have dialogs.
	'all'	Search includes all masked blocks.
'FollowLinks'	'on'   {'off'}	If 'on', search follows links into library blocks. The default is 'off'.
'FindAll'	'on'   {'off'}	If 'on', search extends to lines, ports, and annotations within systems. The default is 'off'. Note that find_system returns a vector of handles when this option is 'on', regardless of the array type of sys.
'CaseSensitive'	{'on'}   'off'	If 'on', search considers case when matching search strings. The default is 'on'.
'RegExp'	'on'   {'off'}	If 'on', search treats search expressions as regular expressions. The default is 'off'.

# find\_system

---

The table encloses default constraint values in brackets. If a 'constraint' is omitted, find\_system uses the default constraint value.

By default, find\_system attempts to load any partially loaded models. When a PreLoadFcn callback invokes find\_system, find\_system tries to load the calling model, causing recursive load warnings. To prevent this warning, disable the model loading property of find\_system. Turn off the LoadFullyIfNeeded property, as follows:

```
find_system(gcs, 'LoadFullyIfNeeded', 'off', 'PropertyName', 'PropertyValue')
```

## Examples

This command returns a cell array containing the names of all open systems and blocks.

```
find_system
```

This command returns the names of all open block diagrams.

```
open_bd = find_system('type', 'block_diagram')
```

This command returns the names of all Goto blocks that are children of the Unlocked subsystem in the clutch system.

```
find_system('clutch/  
Unlocked', 'SearchDepth', 1, 'BlockType', 'Goto')
```

These commands return the names of all Gain blocks in the vdp system having a Gain parameter value of 1.

```
gb = find_system('vdp', 'BlockType', 'Gain')  
find_system(gb, 'Gain', '1')
```

The preceding commands are equivalent to this command:

```
find_system('vdp', 'BlockType', 'Gain', 'Gain', '1')
```



These commands obtain the handles of all lines and annotations in the vdp system.

```
sys = get_param('vdp', 'Handle');
l = find_system(sys, 'FindAll', 'on', 'type', 'line');
a = find_system(sys, 'FindAll', 'on', 'type',
'annotation');
```

## Searching with Regular Expressions

If you specify the 'RegExp' constraint as 'on', `find_system` treats search value strings as regular expressions. A regular expression is a string of characters in which some characters have special pattern-matching significance. For example, a period (.) in a regular expression matches not only itself but any other character.

Regular expressions greatly expand the types of searches you can perform with `find_system`. For example, regular expressions allow you to do partial-word searches. You can search for all objects that have a specified parameter that contains or begins or ends with a specified string of characters.

To use regular expressions effectively, you need to learn the meanings of the special characters that regular expressions can contain. The following table lists the special characters supported by `find_subsystem` and explains their usage.

Expression	Usage
.	Matches any character. For example, the string 'a.' matches 'aa', 'ab', 'ac', etc.
*	Matches zero or more of preceding character. For example, 'ab*' matches 'a', 'ab', 'abb', etc. The expression '.*' matches any string, including the empty string.
+	Matches one or more of preceding character. For example, 'ab+' matches 'ab', 'abb', etc.
^	Matches start of string. For example, '^a.*' matches any string that starts with 'a'.

## find\_system

Expression	Usage
\$	Matches end of string. For example, '.*a\$' matches any string that ends with 'a'.
\	Causes the next character to be treated as an ordinary character. This escape character lets regular expressions match expressions that contain special characters. For example, the search string '\\ ' matches any string containing a \ character.
[]	Matches any one of a specified set of characters. For example, 'f[oa]r' matches 'for' and 'far'. Some characters have special meaning within brackets. A hyphen (-) indicates a range of characters to match. For example, '[a-zA-Z1-9]' matches any alphanumeric character. A circumflex (^) indicates characters that should not produce a match. For example, 'f[^i]r' matches 'far' and 'for' but not 'fir'.
\w	Matches a word character. (This is a shorthand expression for [a-zA-Z0-9].) For example, '^\\w' matches 'mu' but not '&mu'.
\d	Matches any digit (shorthand for [0-9]). For example, '\\d+' matches any integer.
\D	Matches any nondigit (shorthand for [^0-9]).
\s	Matches a white space (shorthand for [ \t\r\n\f]).
\S	Matches a non white-space (shorthand for [^ \t\r\n\f]).
\<WORD\>	Matches WORD exactly, where WORD is a string of characters separated by white space from other words. For example, '\\<to\>' matches 'to' but not 'today'.

To use regular expressions to search Simulink systems, specify the 'regexp' search constraint as 'on' in a find\_system command and use a regular expression anywhere you would use an ordinary search value string.

For example, the following command finds all the inport and outport blocks in the `clutch` model demo provided with Simulink.

```
find_system('clutch', 'regexp', 'on', 'blocktype', 'port')
```

### See Also

`get_param`, `set_param`

## Purpose

Create Simulink.NumericType object describing fixed-point or floating-point data type

## Syntax

```
a = fixdt(Signed, WordLength)
a = fixdt(Signed, WordLength, FractionLength)
a = fixdt(Signed, WordLength, TotalSlope, Bias)
a = fixdt(Signed, WordLength, SlopeAdjustmentFactor,
          FixedExponent, Bias)
a = fixdt(DataTypeNameString)
[DataType, IsScaledDouble] = fixdt(DataTypeNameString)
```

## Description

`fixdt(Signed, WordLength)` returns a Simulink.NumericType object describing a fixed-point data type with unspecified scaling. The scaling would typically be determined by another block parameter. Signed can be 0 (false) for unsigned or 1 (true) for signed.

`fixdt(Signed, WordLength, FractionLength)` returns a Simulink.NumericType object describing a fixed-point data type with binary point scaling.

`fixdt(Signed, WordLength, TotalSlope, Bias)` or `fixdt(Signed, WordLength, SlopeAdjustmentFactor, FixedExponent, Bias)` returns a Simulink.NumericType object describing a fixed-point data type with slope and bias scaling.

`fixdt(DataTypeNameString)` returns a Simulink.NumericType object describing an integer, fixed-point, or floating-point data type specified by a data type name. The data type name can be either the name of a built-in Simulink data type or the name of a fixed-point data type that conforms to the naming convention for fixed-point names established by the Simulink Fixed Point product.

`[DataType, IsScaledDouble] = fixdt(DataTypeNameString)` returns a Simulink.NumericType object describing an integer, fixed-point, or floating-point data type specified by a data type name and a flag that indicates whether the specified data type name was the name of a scaled double data type.

**See Also**      float, sfix, sfrac, sint, ufix, ufrac, uint

# fixpt\_evenspace\_cleanup

---

**Purpose** Modify lookup table input data to be evenly spaced

**Syntax** `xdata_adjusted = fixpt_evenspace_cleanup(xdata_original, xdt, xscale)`

**Description** `xdata_adjusted = fixpt_evenspace_cleanup(xdata_original, xdt, xscale)` modifies lookup table input data to be evenly spaced if it is not quite evenly spaced after quantization. For example, 0:0.005:1 appears evenly spaced, but if it is quantized with scaling  $2^{-12}$ , it is not evenly spaced. Loss of even spacing can make a significant impact on the efficiency of your implementation. Code generated by Real-Time Workshop to implement an uneven lookup table is more complicated. In addition, unevenly spaced input data is stored in data memory. If you modify the input data to remain evenly spaced after quantization, Real-Time Workshop generates simpler code and excludes the input data from memory, thereby saving significant amounts of data memory.

The modifications to the lookup table input data are likely to change the numerical behavior of the table. The numerical changes may or may not be trivial, so you should test the model using simulation, rapid prototyping, or other appropriate methods. This function is intended for use with nontunable data. Tunable data is always treated as if it were unevenly spaced. Even if tunable data starts out evenly spaced, it may later be tuned to values that are unevenly spaced.

It is important to note that the data is judged to be "almost" evenly spaced relative to the scaling slope. Consider the data vector [0 2 5], which has spacing value 2 and 3. A natural first impression is that the data has significantly uneven spacing. However, the difference between the maximum spacing 3 and the minimum spacing 2 equals 1. If the scaling slope is 1 or greater, then a spacing variation of 1 represents a one bit change or less. A spacing variation of one bit or less is judged to be "almost" evenly spaced, and this function will adjust the data to force it to be evenly spaced.

The required input parameters of this function are as follows.

Input	Value	Example
xdata_original	Input lookup data	0:0.005:1
xdt	Input data type	sfix(16)
xscale	Input scaling	2 <sup>-12</sup>

## See Also

fixdt, fixpt\_interp1, fixpt\_look1\_func\_approx, sfix, ufix

# fixpt\_interp1

---

**Purpose** Implement 1-D lookup table

**Syntax** `y = fixpt_interp1(xdata,ydata,x,xdt,xscale,ydt,yscale,rndmeth)`

**Description** `fixpt_interp1(xdata,ydata,x,xdt,xscale,ydt,yscale,rndmeth)` implements a lookup table to find output(s) `y` for input(s) `x`. If `x` falls between two `xdata` values, then `y` is found by interpolating between the corresponding `ydata` pair. If `x` falls above the range given by `xdata`, `y` is given as the maximum `ydata` value. If `x` falls below the range given by `xdata`, `y` is given as the minimum `ydata` value.

If either the input data type, `xdt`, or the output data type, `ydt`, is floating point, then floating-point calculation is used to perform the interpolation. Otherwise, integer-only calculation is used. This calculation handles the input scaling, `xscale`, and the output scaling, `yscale`, appropriately, and obeys the designated rounding method, `rndmeth`.

**Examples** Define `xdata` as a vector of 33 evenly spaced points between 0 and 8, and `ydata` as the sinc of `xdata`.

```
xdata = linspace(0,8,33).';  
ydata = sinc(xdata);
```

Now define your input `x` as a vector of 201 evenly spaced points between -1 and 9.

```
x = linspace(-1,9,201).';
```

Notice that `x` includes some values that are both lower and higher than the range of `xdata`.

You can now use `fixpt_interp1` to interpolate outputs for `x`.

```
y = fixpt_interp1(xdata,ydata,x,sfix(8),2^-3,sfix(16),...  
2^-14,'Floor')
```



**See Also**      `fixpt_look1_func_approx`, `fixpt_look1_func_plot`

# fixpt\_look1\_func\_approx

---

## Purpose

Optimize for fixed-point function, x values, or breakpoints that are generated for lookup table

## Syntax

```
[xdata,ydata,errworst]=fixpt_look1_func_approx('funcstr',...  
xmin,xmax,xdt,xscale,ydt,yscale,rndmeth,errmax,nptsmax)
```

```
[xdata,ydata,errworst]=fixpt_look1_func_approx('funcstr',...  
xmin,xmax,xdt,xscale,ydt,yscale,rndmeth,errmax,[])
```

```
[xdata,ydata,errworst]=fixpt_look1_func_approx('funcstr',...  
xmin,xmax,xdt,xscale,ydt,yscale,rndmeth,[],nptsmax)
```

```
[xdata,ydata,errworst]=fixpt_look1_func_approx('funcstr',...  
xmin,xmax,xdt,xscale,ydt,yscale,rndmeth,errmax,nptsmax,spacing)
```

## Description

`fixpt_look1_func_approx('funcstr',xmin,xmax,xdt,xscale,ydt,yscale,rndmeth,errmax,nptsmax)` optimizes the breakpoints of a lookup table over a specified range. The lookup table satisfies the maximum acceptable error, maximum number of points, and spacing requirements given by the optional parameters. The breakpoints refer to the x values of the lookup table. The command

```
[xdata,ydata,errworst]=fixpt_look1_func_approx('funcstr',...  
xmin,xmax,xdt,xscale,ydt,yscale,rndmeth,errmax,[])
```

returns the *x*- and *y*- coordinates of the lookup table as vectors `xdata` and `ydata`, respectively. It also returns the maximum absolute error of the lookup table as a variable `errworst`.

The fixed-point approximation is found by interpolating between the lookup table data points. The required input parameters are as follows.

Input	Value
'funcstr'	Function of x funcstr is the function for which breakpoints are approximated.
xmin	Minimum value of x
xmax	Maximum value of x
xdt	Data type of x
xscale	Scaling for the x values
ydt	Data type of y
yscale	Scaling for the y values
rndmeth	Rounding mode supported by fixed-point Simulink blocks: 'Toward Zero', 'Nearest', 'Floor' (default value), 'Ceiling'

- xmin and xmax specify the range over which the breakpoints are approximated.
- xdt, xscale, ydt, yscale, and rndmeth follow conventions used by fixed-point Simulink blocks.
- rndmeth has a default value listed in the input table.

In addition to the required parameters, there are three optional inputs, as follows.

Input	Value
errmax	Maximum acceptable error
nptsmax	Maximum number of points
spacing	Spacing: 'even', 'pow2' (even power of 2), 'unrestricted' (default value)

Of these, you must use at least one of the parameters errmax and nptsmax. If you omit one of these, you must use brackets, [ ], in place of

## fixpt\_look1\_func\_approx

---

the omitted parameter. The function will then ignore that requirement for the lookup table.

The outputs of the function are as follows.

Output	Value
xdata	The breakpoints for the lookup table
ydata	The ideal function applied to the breakpoints
errworst	The worst case error, which is the maximum absolute error between the ideal function and the approximation given by the lookup table

### Criteria For Optimizing the Breakpoints: **errmax**, **nptsmax**, and **spacing**

The approximation produced from the lookup table must satisfy the requirements for the maximum acceptable error, **errmax**, the maximum number of points, **nptsmax**, and the spacing, **spacing**. The requirements are

- The maximum absolute error is less than **errmax**.
- The number of points required is less than **nptsmax**.
- The spacing is specified as unrestricted, even or even power of 2.

### Modes for **errmax** and **nptsmax**

- If both **errmax** and **nptsmax** are specified  
The returned breakpoints will meet both criteria if possible. The **errmax** parameter is given priority, and **nptsmax** is ignored, if both criteria cannot be met with the specified spacing.
- If only **errmax** is specified  
The breakpoints that meet the error criteria, and have the least number of points are returned
- If only **nptsmax** is specified

The breakpoints that require `nptsmax` or fewer, and give the smallest worst case error are returned

## Modes for Spacing

If no spacing is specified, and more than one spacing method meets the requirements given by `errmax` and `nptsmax`, power of 2 spacing is chosen over even spacing, which in turn is chosen over uneven spacing. This case occurs when the `errmax` and `nptsmax` are both specified, but typically does not occur when only one is specified:

- If `unrestricted` is entered, the function chooses the spacing that provides the best optimization.
- If `even` is entered, the function chooses an evenly spaced set of points, including the `pow2` spacing.
- If `pow2` spacing is entered, the function chooses an even power of 2 spaced set of points.

---

**Note** The global optimum may not be found. The worst case error can depend on fixed-point calculations, which are highly nonlinear. Furthermore, the optimization approach is heuristic.

---

The spacing you choose depends on the parameters you want to optimize: execution speed, function approximation error, ROM usage, and RAM usage:

- The execution speed depends on the bisection search, and the interpolation method.
- The error depends on how accurately the method approximates the nonuniform curvature of the function.
- The ROM usage depends on the amount of data and command ROM used.
- The RAM usage depends on how much global and stack RAM is used.

When the lookup table has even power of two spacing, division is replaced by a bit shift. As a result, the execution speed is faster than for evenly spaced data.

## Using the Approximation Function

- 1 Choose a function and use the `eval('funcstr');` command to view the function before creating the lookup table.
- 2 Define the remaining inputs.
- 3 Run the `fixpt_look1_func_approx` function.
- 4 Use the `fixpt_look1_func_plot` function to plot the function from the selected breakpoints, and to calculate the error and the number of points used.
- 5 Vary the inputs to produce sets of breakpoints that generate functions with varying number of points required and worst case error.
- 6 Compare the number of points required and worst case error from various runs to choose the best set of breakpoints.

## Calculating the Output Function

To calculate the function, use the returned breakpoints with

- The `eval` function
- A function lookup table. The `x` values are the breakpoints from the `fixpt_look1_func_approx` function, and the `y` values can be supplied using the `eval` function.

See “Tutorial: Producing Lookup Table Data” in *Simulink Fixed Point User’s Guide* for a tutorial on using `fixpt_look1_func_approx`.

The following table summarizes the effect of spacing on the execution speed, error, and memory used.

<b>Parameter</b>	<b>Even Power of 2 Spaced Data</b>	<b>Evenly Spaced Data</b>	<b>Unevenly Spaced Data</b>
Execution Speed	The execution speed is the fastest. The position search and interpolation are the same as for evenly spaced data. However, to increase the speed more, the position search is replaced by a bit shift, and the interpolation is replaced with a bit mask.	The execution speed is faster than that for unevenly spaced data because the position search is faster and the interpolation requires a simple division.	The execution speed is the slowest of the different spacings because the position search is slower, and the interpolation requires more operations.
Error	The error can be larger than that for unevenly spaced data because approximating a function with nonuniform curvature requires more points to achieve the same accuracy.	The error can be larger than that for unevenly spaced data because approximating a function with nonuniform curvature requires more points to achieve the same accuracy.	The error can be smaller because approximating a function with nonuniform curvature requires fewer points to achieve the same accuracy.
ROM Usage	Uses less command ROM, but more data ROM.	Uses less command ROM, but more data ROM.	Uses more command ROM, and less data ROM.
RAM Usage	Not significant.	Not significant.	Not significant.

# fixpt\_look1\_func\_approx

---

## Examples

This example produces a lookup table for a sine function. The inputs for the example are as follows:

```
funcstr = 'sin(2*pi*x)';
xmin = 0;
xmax = 0.25;
xdt = ufix(16);
xscale = 2^-16;
ydt = sfix(16);
yscale = 2^-14;
rndmeth = 'Floor';
errmax = 2^-10;
spacing = 'pow2';
```

To create the lookup table, type

```
[xdata, ydata, errWorst]=fixpt_look1_func_approx(funcstr,...
xmin,xmax,xdt,xscale,ydt,yscale,rndmeth,errmax,[],spacing);
```

The brackets [] are a place holder for the `nptsmax` parameter, which is not used in this example.

You can then plot the ideal function, the approximation, and the errors by typing

```
fixpt_look1_func_plot(xdata,ydata,funcstr,xmin,xmax,xdt,...
xscale,ydt,yscale,rndmeth);
```

The `fixpt_look1_func_plot` function produces a plot of the fixed-point sine function, using these breakpoints, and a plot of the error between the ideal function and the fixed-point function. The maximum absolute error and the number of points required are listed with the plot. The error drops to zero at a breakpoint, and increases between breakpoints due to the difference in curvature of the ideal function and the line drawn between breakpoints.

The resulting plots are shown.



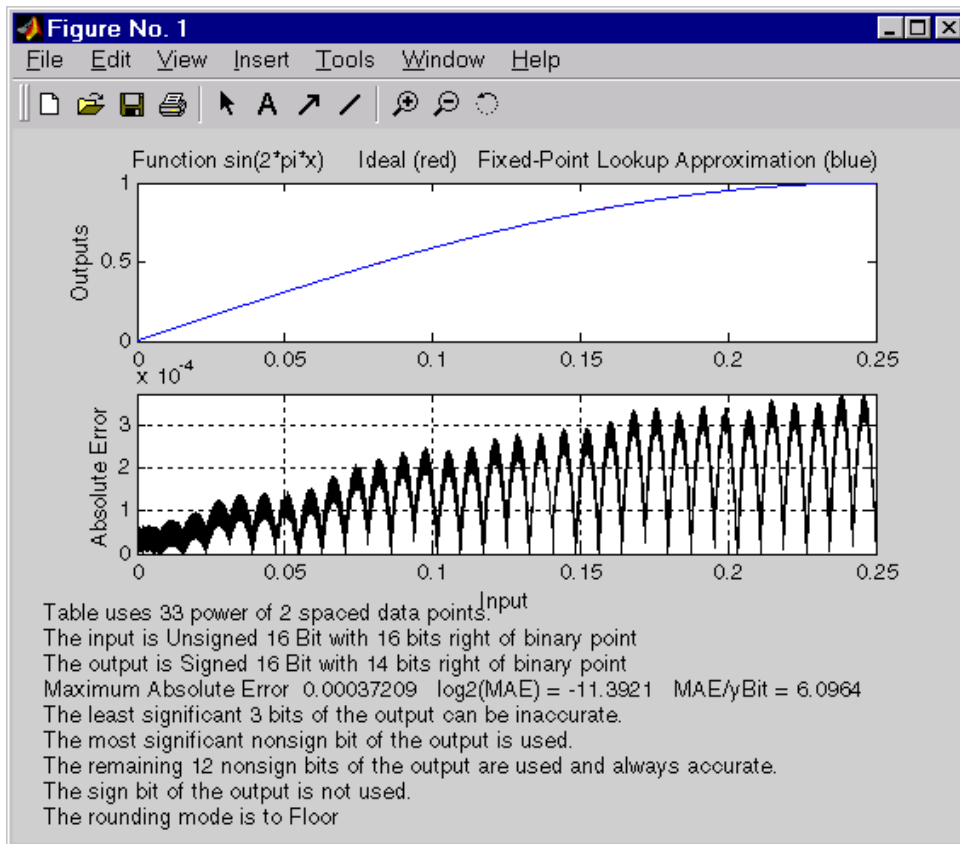

The lookup table requires 33 points to achieve a maximum absolute error of  $2^{-11.3922}$ .

**See Also** `fixpt_look1_func_plot`

# fixpt\_look1\_func\_plot

---

**Purpose** Plot function with x values generated by `fixpt_look1_func_approx` function

**Syntax** `errworst = fixpt_look1_func_plot(xdata,ydata,'funcstr',  
xmin,xmax,xdt,xscale,ydt,yscale,rndmeth)`

**Description** `fixpt_look1_func_plot(xdata,ydata,'funcstr',xmin,xmax,xdt,xscale,ydt,yscale,rndmeth)` plots a lookup table approximation function and its error from the ideal function. You can use the `fixpt_look1_func_approx` function to generate `xdata` and `ydata`, the *x* and *y* data points for the lookup table. The function returns the maximum absolute error as a variable `errworst`. The inputs are as follows.

Input	Value
<code>xdata</code>	x values for the lookup table
<code>ydata</code>	y values for the lookup table
<code>'funcstr'</code>	Function of x
<code>xmin</code>	Minimum input of interest
<code>xmax</code>	Maximum input of interest
<code>xdt</code>	Data type of x
<code>xscale</code>	Scaling for the x values
<code>ydt</code>	Data type of y
<code>yscale</code>	Scaling for the y values
<code>rndmeth</code>	Rounding mode supported by the blockset: 'Toward Zero', 'Nearest', 'Floor', 'Ceiling'

The `fixpt_look1_func_approx` function applies the ideal function to the points in `xdata` to produce `ydata`. While this is the easiest way to generate `ydata`, you are not required to use these values for `ydata` as input for the `fixpt_look1_func_approx` function. Choosing different

values for ydata can, in some cases, produce a lookup table with a smaller maximum absolute error.

See “Tutorial: Producing Lookup Table Data” in *Simulink Fixed Point User’s Guide* for a tutorial on using `fixpt_look1_func_plot`. For an example of the function, see `fixpt_look1_func_approx` function.

### **See Also**

`fixpt_look1_func_approx`

# fixpt\_set\_all

---

**Purpose** Set property for every fixed-point block in subsystem

**Syntax** `fixpt_set_all(SystemName,fixptPropertyName,fixptPropertyValue)`

**Description** `fixpt_set_all` sets the property `fixptPropertyName` of every applicable block in the model or subsystem `SystemName` to the value `fixptPropertyValue`.

**Examples** To set every fixed-point block in a model called `Filter_1` to round toward the floor and to saturate upon overflow, type

```
fixpt_set_all('Filter_1','RndMeth','Floor')
fixpt_set_all('Filter_1','DoSatur','on')
```

**Purpose** Determine exponent that gives best precision fixed-point representation of value

**Syntax**  
`out = fixptbestexp(RealWorldValue,TotalBits,IsSigned)`  
`out = fixptbestexp(RealWorldValue,FixPtDataType)`

**Description**  
`out = fixptbestexp(RealWorldValue,TotalBits,IsSigned)` determines the exponent that gives the best precision for the fixed-point representation of the real-world value specified by `RealWorldValue`. You specify the number of bits for the fixed-point number with `TotalBits`, and you specify whether the fixed-point number is signed with `IsSigned`. If `IsSigned` is 1, the number is signed. If `IsSigned` is 0, the number is not signed. The exponent is returned to `out`.  
`out = fixptbestexp(RealWorldValue,FixPtDataType)` determines the exponent that gives the best precision based on the data type specified by `FixPtDataType`.

**Examples**  
The following command returns the exponent that gives the best precision for the real-world value  $4/3$  using a signed, 16-bit number:

```
out = fixptbestexp(4/3,16,1)
out =
    -14
```

Alternatively, you can specify the fixed-point data type:

```
out = fixptbestexp(4/3,sfix(16))
out =
    -14
```

This value means that the maximum precision representation of  $4/3$  is obtained by placing 14 bits to the right of the binary point:

```
01.01010101010101
```

# fixptbestexp

---

You would specify the precision of this representation in fixed-point blocks by setting the scaling to  $2^{-14}$  or  $2^{\text{fixptbestexp}(4/3, 16, 1)}$ .

## See Also

`fixptbestprec`

**Purpose** Determine maximum precision available for fixed-point representation of value

**Syntax**

```
out = fixptbestprec(RealWorldValue,TotalBits,IsSigned)
out = fixptbestprec(RealWorldValue,FixPtDataType)
```

**Description**

`out = fixptbestprec(RealWorldValue,TotalBits,IsSigned)` determines the maximum precision for the fixed-point representation of the real-world value specified by `RealWorldValue`. You specify the number of bits for the fixed-point number with `TotalBits`, and you specify whether the fixed-point number is signed with `IsSigned`. If `IsSigned` is 1, the number is signed. If `IsSigned` is 0, the number is not signed. The maximum precision is returned to `out`.

`out = fixptbestprec(RealWorldValue,FixPtDataType)` determines the maximum precision based on the data type specified by `FixPtDataType`.

## Examples

### Example 1

The following command returns the maximum precision available for the real-world value  $4/3$  using a signed, 8-bit number:

```
out = fixptbestprec(4/3,8,1)
out =
    0.015625
```

Alternatively, you can specify the fixed-point data type:

```
out = fixptbestprec(4/3,sfix(8))
out =
    0.015625
```

This value means that the maximum precision available for 4/3 is obtained by placing six bits to the right of the binary point since  $2^{-6}$  equals 0.015625:

01.010101

## Example 2

You can use the maximum precision as the scaling in fixed-point blocks. This enables you to use `fixptbestprec` to perform a type of autoscaling if you would like to designate a known range of your simulation. For example, if your known range is -13 to 22, and you are using a safety margin of 30%:

```
knownMax = 22;  
knownMin = -13;  
localSafetyMargin = 30;  
slope = max( fixptbestprec( (1+localSafetyMargin/100)* ...  
    [knownMax,knownMin], sfix(16) ) );
```

The variable `slope` can then be used in the expression that you specify for the **Output data type** parameter in a block mask. Be sure to select the **Lock output scaling against changes by the autoscaling tool** parameter in the same block to prevent the scaling from being overridden by the Fixed-Point Tool. If you know the range, you can use this technique in place of relying on a model simulation to provide the range to the autoscaling tool, as described in `autofixexp` in *Simulink Fixed Point User's Guide*.

## See Also

`fixptbestexp`



---

<b>Purpose</b>	Create MATLAB structure describing floating-point data type
<b>Syntax</b>	<pre>a = float('single') a = float('double') a = float(TotalBits, ExpBits)</pre>
<b>Description</b>	<p><code>float('single')</code> returns a MATLAB structure that describes the data type of an IEEE single (32 total bits, 8 exponent bits).</p> <p><code>float('double')</code> returns a MATLAB structure that describes the data type of an IEEE double (64 total bits, 11 exponent bits).</p> <p><code>float(TotalBits, ExpBits)</code> returns a MATLAB structure that describes a nonstandard floating-point data type that mimics the IEEE style. That is, the numbers are normalized with a hidden leading one for all exponents except the smallest possible exponent. However, the largest possible exponent might not be treated as a flag for Infs and NaNs.</p> <p><code>float</code> is automatically called when a floating-point number is specified in a block dialog box.</p>
<b>Examples</b>	<p>Define a nonstandard, IEEE-style, floating-point data type with 31 total bits (excluding the hidden leading one) and 9 exponent bits:</p> <pre>a = float(31,9) a =     Class: 'FLOAT'     MantBits: 21     ExpBits: 9</pre>
<b>See Also</b>	<code>fixdt</code> , <code>sfix</code> , <code>sfrac</code> , <code>sint</code> , <code>ufix</code> , <code>ufrac</code> , <code>uint</code>

**Purpose** Invoke Fixed-Point Tool

**Syntax** `fxptdlg('modelName')`

**Description** `fxptdlg('modelName')` launches the Fixed-Point Tool for the Simulink model specified by `modelName`. You can also access this tool by the following methods:

- From the Simulink **Tools** menu, select **Fixed-Point Settings**.
- From a system or subsystem context (right-click) menu, select **Fixed-Point Settings**.

In conjunction with Simulink Fixed Point, the Fixed-Point Tool provides convenient access to

- Model and subsystem parameters that control data type override and min/max overflow logging, namely, `DataTypeOverride`, `MinMaxOverflowArchiveMode`, and `MinMaxOverflowLogging` (see “Model Parameters” on page 8-2).
- Plotting capabilities that enable you to plot data that resides in the MATLAB workspace, namely, simulation results associated with Scope, To Workspace, and root-level Outport blocks, in addition to logged signal data (see “Logging Signals” in *Using Simulink*).
- An interactive autoscaling feature that proposes fixed-point scaling for appropriately configured blocks in your model, and then allows you to selectively accept and apply the scaling proposals.

You can launch the Fixed-Point Tool for any system or subsystem, and the tool controls the object selected in its **Model Hierarchy** pane. If Simulink Fixed Point is installed, Fixed-Point Tool’s **Contents** pane displays the name, minimum simulation value, maximum simulation value, data type, and scaling of each block in the model that logs fixed-point data. Additionally, if a signal saturates or overflows, the tool displays the number of times saturation or overflow occurred. You can

display a block's dialog box by right-clicking the appropriate block entry in the **Contents** pane and selecting **Properties**.

---

**Note** The Fixed-Point Tool works only for models that simulate in Normal mode. The tool does not work when you simulate your model in Accelerator or Rapid Accelerator mode (see “Accelerating Simulink Models” in *Using Simulink*).

---

Most of the functionality in the Fixed-Point Tool is for use with Simulink Fixed Point. However, even if you do not have Simulink Fixed Point, you can use data type override mode to simulate a model that specifies fixed-point data types. In this mode, Simulink replaces fixed-point values with floating-point values when simulating the model. Data type override mode allows you to share fixed-point models with people in your company who do not have Simulink Fixed Point.

To simulate a model in data type override mode:

- 1** From the Simulink **Tools** menu, select **Fixed-Point Settings**.

The Fixed-Point Tool appears.

- 2** Set the **Logging mode** parameter to Force off.

- 3** Set the **Data type override** parameter to True doubles or True singles.

---

**Note** If you specify a `fi` object as a fixed-point parameter in your model, you need a Fixed-Point Toolbox license to simulate the model in data type override mode.

---

## Parameters and Dialog Box

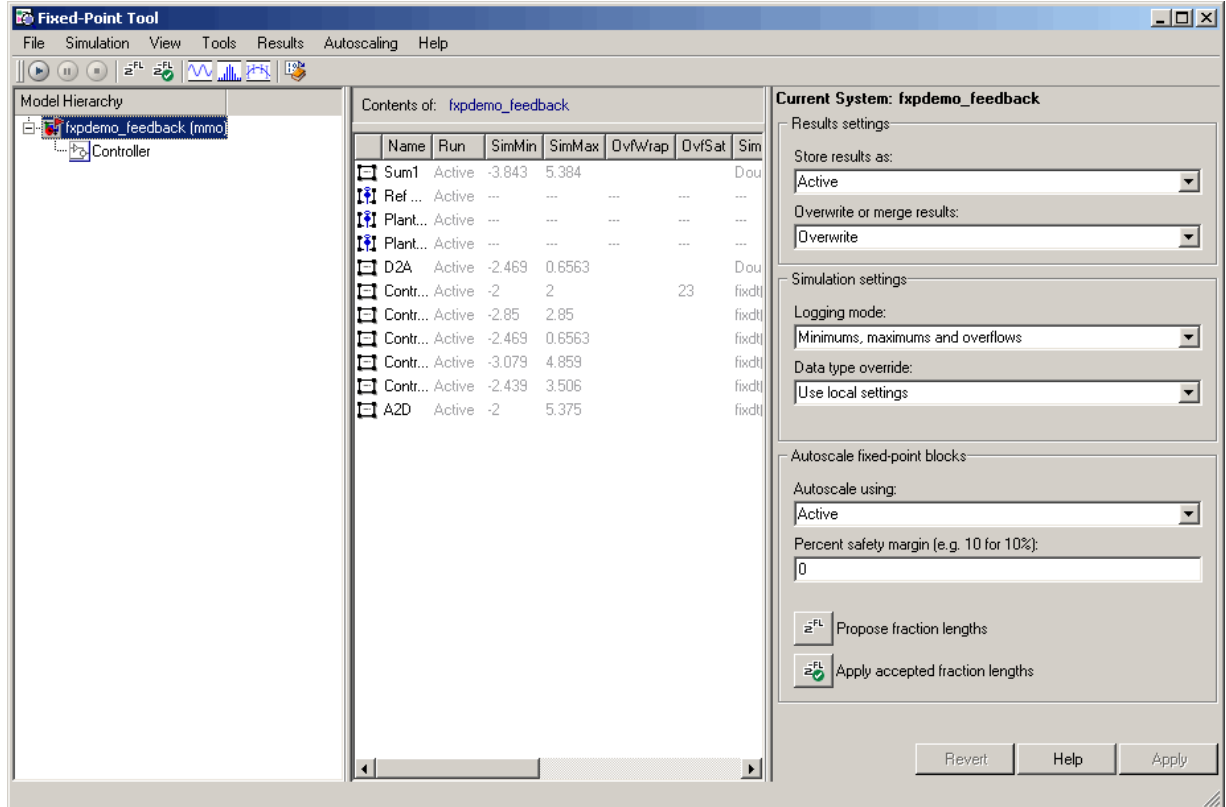

The Fixed-Point Tool includes the following components:

- **Model Hierarchy** pane (see “Model Hierarchy Pane” on page 4-61)
- **Contents** pane (see “Contents Pane” on page 4-61)

- **Dialog** pane (see “Dialog Pane” on page 4-66)
- **Main** toolbar (see “Main Toolbar” on page 4-70)

### Model Hierarchy Pane

The **Model Hierarchy** pane displays a tree-structured view of the Simulink model hierarchy as shown here.

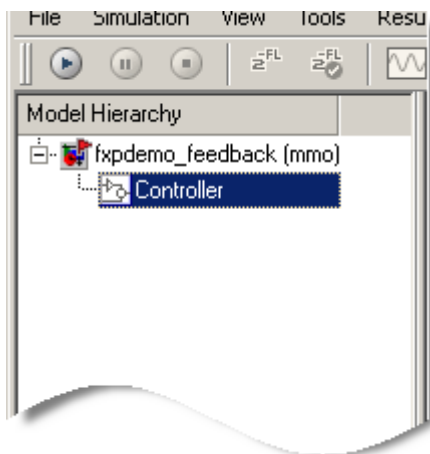

The first node in the view represents a Simulink model. Expanding the root node displays nodes representing the Simulink model’s subsystems, Embedded MATLAB Function blocks, and Stateflow charts. The Fixed-Point Tool’s **Dialog** pane displays information associated with the object selected in the **Model Hierarchy** pane; likewise, the **Contents** pane displays simulation results associated with that object.

### Contents Pane

The **Contents** pane displays a tabular view of blocks that log fixed-point data in the system or subsystem selected in the **Model Hierarchy** pane. The table rows correspond to blocks; the table columns correspond to simulation results, such as the minimum value, maximum value, and data type.

Contents of: `fxpdemo_feedback`

Name ▲	Run	SimMin	SimMax	OvfWrap	OvfSat	SimDT	Sp
[-] A2D	Active	-2	5.375			fixdt(1,8,4)	
[-] Controller/Combine Terms	Active	-2.439	3.506			fixdt(1,32,12)	
[-] Controller/Denominator Terms	Active	-3.079	4.859			fixdt(1,32,12)	
[-] Controller/Down Cast	Active	-2.469	0.6563			fixdt(1,16,5)	
[-] Controller/Numerator Terms	Active	-2.85	2.85			fixdt(1,32,12)	
[-] Controller/Up Cast	Active	-2	2		23	fixdt(1,16,14)	
[-] D2A	Active	-2.469	0.6563			Double	
[+] Plant Input	Active	---	---	---	---	---	---
[+] Plant Output	Active	---	---	---	---	---	---
[+] Ref Signal	Active	---	---	---	---	---	---
[-] Sum1	Active	-3.843	5.384			Double	

**Note** The **Contents** pane displays simulation results for blocks only after you simulate a system.

The **Contents** pane displays columns that correspond to the following properties and controls:

Column Label	Description
<b>Name</b>	Identifies path and name of block.
<b>Run</b>	Indicates whether the Fixed-Point Tool stores results as an active or a reference run.
<b>SimMin</b>	Minimum value that occurs during simulation.
<b>SimMax</b>	Maximum value that occurs during simulation.

<b>Column Label</b>	<b>Description</b>
<b>OvfWrap</b>	Number of overflows that wrap during simulation.
<b>OvfSat</b>	Number of overflows that saturate during simulation.
<b>SimDT</b>	Data type the block uses during simulation.
<b>SpecifiedDT</b>	Data type the block specifies in its parameter dialog box.
<b>ProposedFL</b>	Fraction length that the Fixed-Point Tool proposes.
<b>ProposedRange</b>	Range that results from the Fixed-Point Tool's scaling proposal.
<b>Accept</b>	Check box that enables you to selectively accept the Fixed-Point Tool's scaling proposal.
<b>Comments</b>	Remarks that result from the Fixed-Point Tool's autoscaling analysis.
<b>SimDTRange</b>	Range that results from the data type Simulink uses during simulation.
<b>DivByZero</b>	Number of divide-by-zero instances that occur during simulation.

The following topics describe ways in which you can customize the **Contents** pane:

- “Changing Column Order and Width”
- “Sorting Rows by Column”
- “Hiding Columns”

### **Changing Column Order and Width**

You can alter the order and width of columns that appear in the **Contents** pane as follows:

- To move a column, click and drag the head of a column to a new location among the column headers.
- To make a column wider or narrower, click and drag the right edge of a column header. If you double-click the right edge of a column header, the column width changes to fit its contents.

### **Sorting Rows by Column**

By default, the **Contents** pane displays its contents in ascending order of the **Name** column. You can alter the order in which the **Contents** pane displays its rows as follows:

- To sort all the rows in ascending order of another column, click the head of that column.
- To change the order from ascending to descending, simply click again on the head of that column.

### **Hiding Columns**

You can select the properties that the **Contents** pane displays or hides by using the **Customize Contents** pane. When visible, the pane appears in the lower-left corner of the Fixed-Point Tool window.



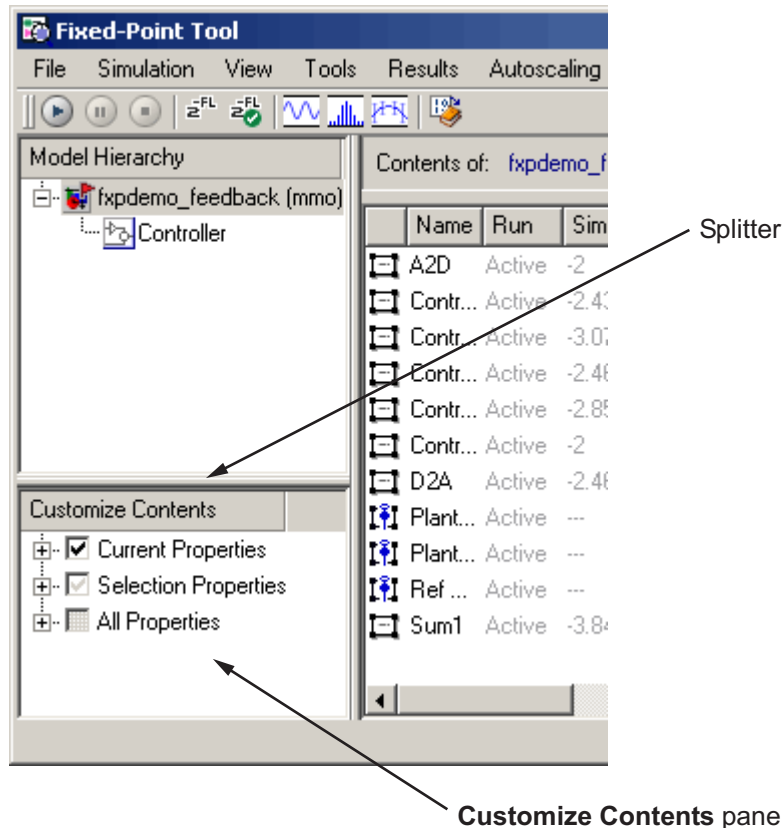

- To access the **Customize Contents** pane, from the Fixed-Point Tool **View** menu, select **Customize Contents**. A splitter divides the **Customize Contents** pane from the **Model Hierarchy** pane above it. Drag the splitter up or down to adjust the relative size of the two panes.
- To hide properties from the **Contents** pane, in the **Customize Contents** pane, expand the **Current Properties** node and uncheck the properties that you do not want to appear.

- To display additional properties in the **Contents** pane, in the **Customize Contents** pane, expand the All Properties node and select the desired properties.

## Dialog Pane

Use the **Dialog** pane to view and change particular properties associated with the object selected in the **Model Hierarchy** pane.

The dialog box is titled "Current System: fxpdemo\_feedback" and is divided into three main sections:

- Results settings:**
  - Store results as: Active
  - Overwrite or merge results: Overwrite
- Simulation settings:**
  - Logging mode: Minimums, maximums and overflows
  - Data type override: Use local settings
- Autoscale fixed-point blocks:**
  - Autoscale using: Active
  - Percent safety margin (e.g. 10 for 10%): 0

At the bottom, there are two buttons with a  $z^{-FL}$  icon:

- Propose fraction lengths
- Apply accepted fraction lengths

---

**Tip** From the Fixed-Point Tool **View** menu, you can select **Dialog View** to hide the **Dialog** pane, making more room for the other components.

---

The **Dialog** pane displays the following properties:

#### **Store results as**

Controls how the Fixed-Point Tool stores simulation results:

- **Active** — Stores simulation results as an active run, denoted by the **Active** label in the **Run** column of the **Contents** pane.
- **Reference** — Stores simulation results as a reference run, denoted by the **Reference** label in the **Run** column of the **Contents** pane.

#### **Overwrite or merge results**

Controls the logging type:

- **Overwrite** — Completely clears existing simulation results from the **Contents** pane before displaying new simulation results.
- **Merge** — Merges new simulation results with existing simulation results in the **Contents** pane.

#### **Logging mode**

Controls which blocks log data. The value of this parameter for parent systems controls logging for all child subsystems, unless `Use local settings` is selected:

- `Use local settings` — Data is logged according to the value of this parameter set for each subsystem. Otherwise, settings for parent systems always override those of child systems.
- `Minimums, maximums and overflows` — Minimum value, maximum value, and overflow data is logged for all blocks in the current system or subsystem.

- `Overflows only` — Only overflow data is logged for all blocks in the current system or subsystem.
- `Force off` — No data is logged for any block in the current system or subsystem. Use this selection to work with models containing fixed-point enabled blocks if you do not have a Simulink Fixed Point license.

## **Data type override**

Controls data type override of blocks that allow you to specify data types in their block masks. The value of this parameter for parent systems controls data type override for all child subsystems, unless `Use local settings` is selected:

- `Use local settings` — Data types are overridden according to the value of this parameter set for each subsystem. Otherwise, settings for parent systems override those of child systems.
- `Scaled doubles` — The output data type of all blocks in the current system or subsystem is overridden with doubles; however, the scaling and bias specified in the mask of each block is maintained.
- `True doubles` — The output data type of all blocks in the current system or subsystem is overridden with true doubles. The overridden values have no scaling or bias.
- `True singles` — The output data type of all blocks in the current system or subsystem is overridden with true singles. The overridden values have no scaling or bias.
- `Force off` — No data type override is performed on any block in the current system or subsystem.

Set this parameter to `True doubles` or `True singles` to work with models containing fixed-point enabled blocks if you do not have a Simulink Fixed Point license.

---

**Note** The following Simulink blocks allow you to set data types in their block masks, but ignore the **Data type override** setting: Probe, Trigger, Width. The Embedded MATLAB Function block ignores the **Data type override** parameter if it specifies Scaled doubles.

---

### **Autoscale using**

Controls which set of simulation results the Fixed-Point Tool uses when autoscaling:

- **Active** — Performs autoscaling using the simulation results stored in the active run.
- **Reference** — Performs autoscaling using the simulation results stored in the reference run.

### **Percent safety margin**

The Fixed-Point Tool uses the **Percent safety margin** parameter when autoscaling. Before performing autoscaling, you must run the simulation to collect min/max data. To learn how to do this, see “Tutorial: Feedback Controller Simulation” in the Simulink Fixed Point documentation.







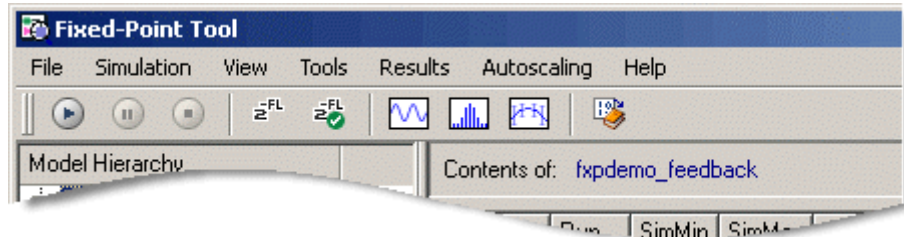

Simulation values are multiplied by the factor designated by this parameter, allowing you to specify a range different from that defined by the maximum and minimum values logged to the workspace. For example, a value of 55 specifies that a range *at least* 55 percent larger is desired. A value of -15 specifies that a range *up to* 15 percent smaller is acceptable.

## Main Toolbar

The Fixed-Point Tool's main toolbar appears near the top of the Fixed-Point Tool window under the Fixed-Point Tool's menu.



The toolbar contains the following buttons that execute commonly used Fixed-Point Tool commands:

Button	Usage
	Begin simulating a model.
	Pause a simulation.
	Stop a simulation.
	Propose fraction lengths.
	Apply accepted fraction lengths.
	Create a time series plot.
	Create a histogram plot.
	Create a time series difference (A-R) plot.
	Store active as reference run.

## Plot Interface

The Fixed-Point Tool provides plotting capabilities that enable you to plot signals for graphical analysis. The tool can access signal data that resides in the MATLAB workspace, allowing you to plot simulation results associated with

- Scope blocks whose **Save data to workspace** parameter is selected
- To Workspace blocks
- Root-level Outport blocks, when the **Output** check box on the **Data Import/Export** pane of the Configuration Parameters dialog box is selected
- Logged signal data (see “Logging Signals” in *Using Simulink*)

---

**Tip** The **Contents** pane of the Fixed-Point Tool displays an antenna icon  next to items that you can plot.

---

You can create the following types of plots using the Fixed-Point Tool's interface:

- Time series plot — Plots data as a function of time.

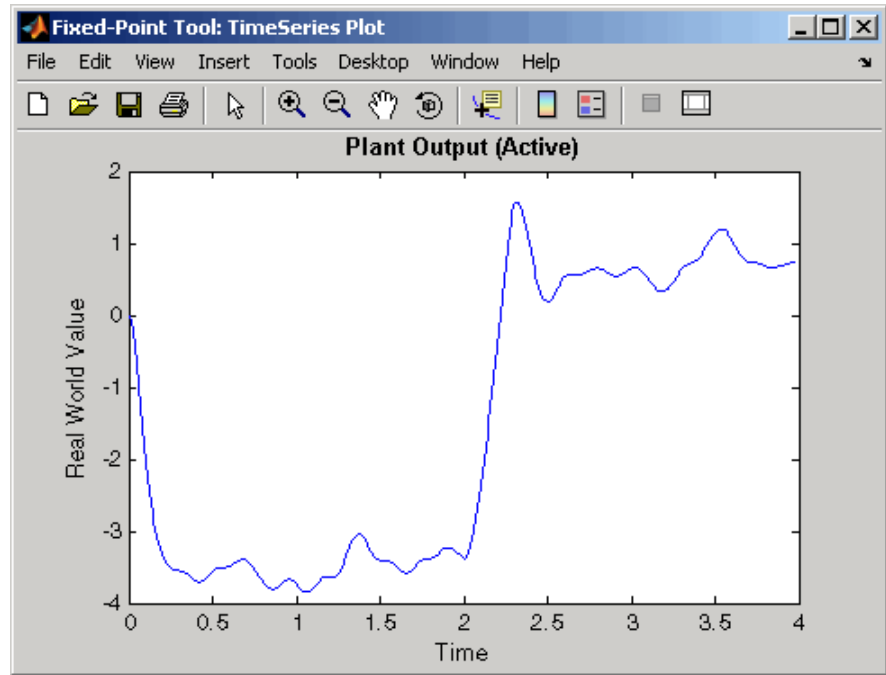



- Histogram plot — Plots the number of data values that occur at each bit.

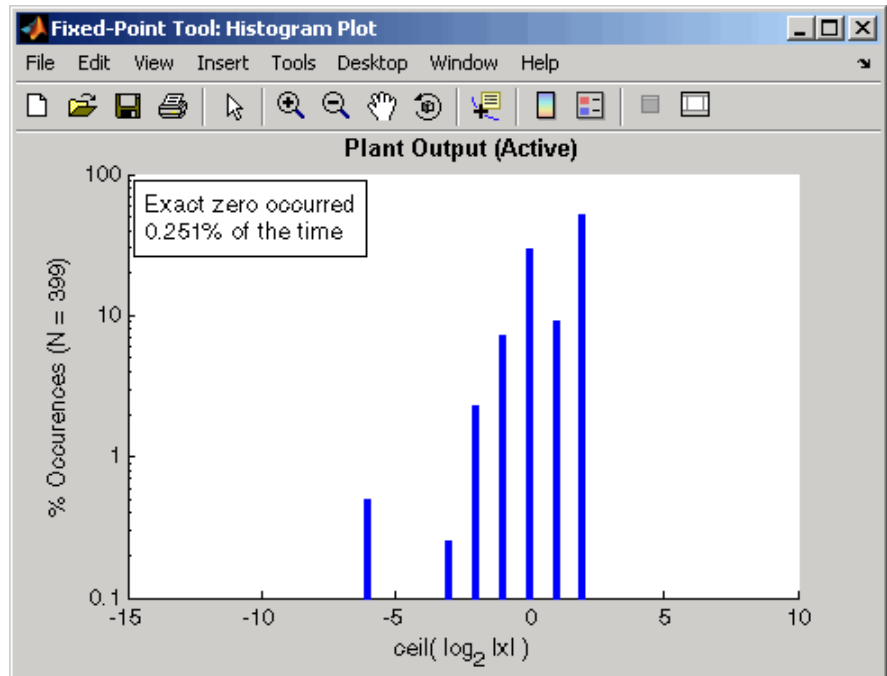

- Time series difference (A-R) plot — Plots both the active and reference versions of a signal on the upper axes, and plots the difference between the active and reference versions of that signal on the lower axes.

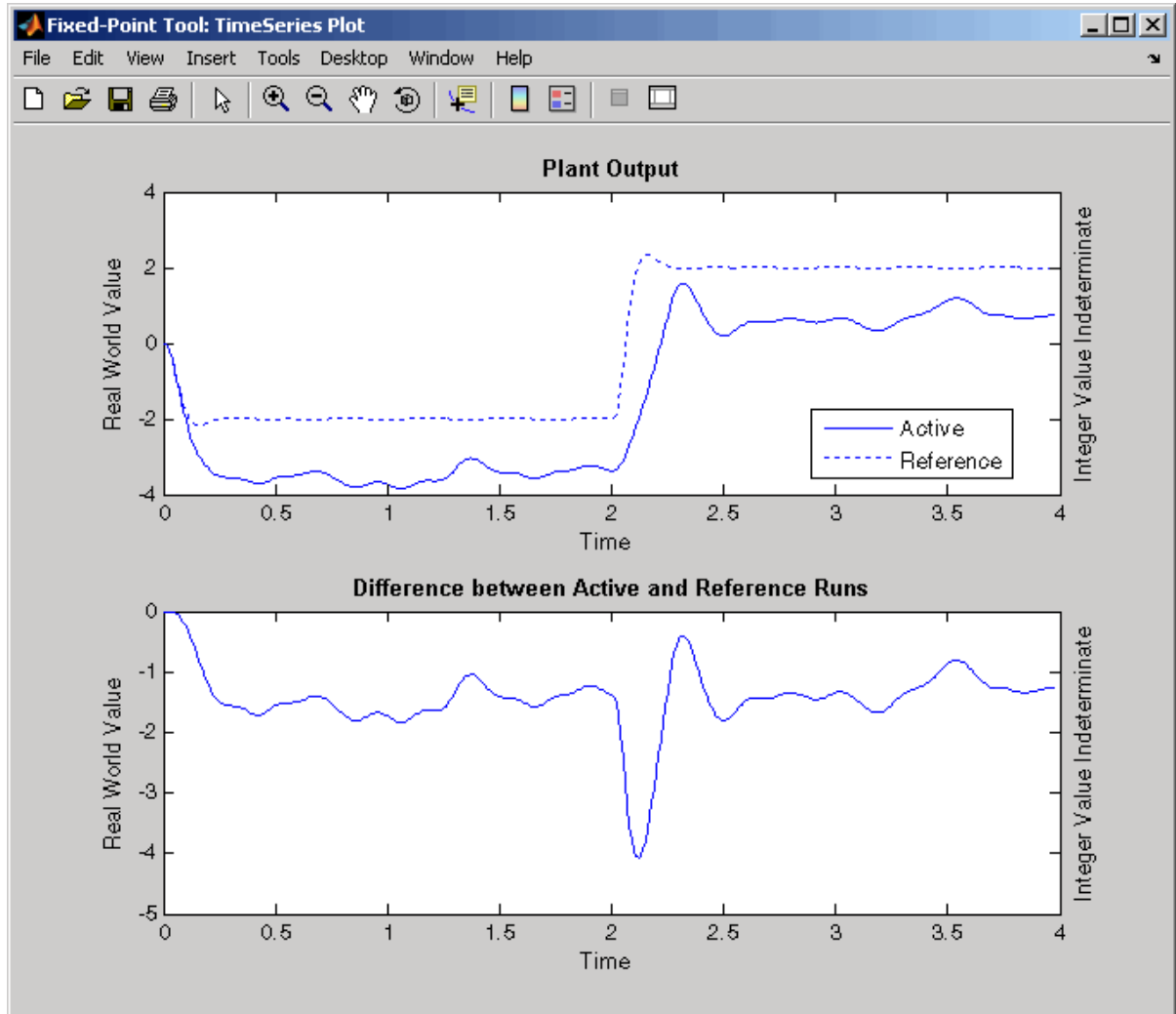

## Signal Logging Options

The Fixed-Point Tool provides options that allow you to control signal logging in a model (see “Logging Signals” in *Using Simulink*). Using these options, you can enable or disable logging for multiple signals simultaneously, based on signal attributes such as:

- The location of signals in a model hierarchy
- Whether or not signals have names

To access the signal logging options in the Fixed-Point Tool:

- 1 In the **Model Hierarchy** pane, right-click a node that represents either a model or a subsystem.

The Fixed-Point Tool displays a context menu for the selected node.

- 2 In the context menu, select either **Enable Signal Logging** or **Disable Signal Logging**.

The Fixed-Point Tool displays a submenu that lists a variety of signal logging options.

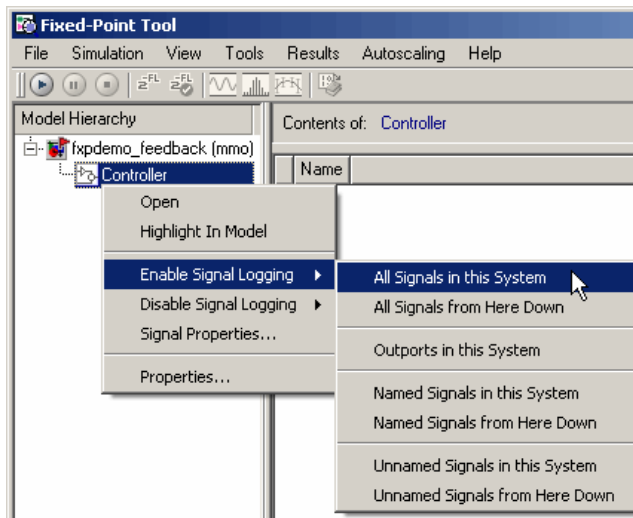

Choose from the following signal logging options:

Select...	To Enable or Disable Signal Logging for...
<b>All Signals in this System</b>	All signals in the selected system
<b>All Signals from Here Down</b>	All signals in the selected system and its subsystems
<b>Outputs in this System</b>	All Output blocks in the selected system
<b>Named Signals in this System</b>	All signals in the selected system, whose <b>Signal name</b> parameter specifies a value
<b>Named Signals from Here Down</b>	All signals in the selected system and its subsystems, whose <b>Signal name</b> parameter specifies a value
<b>Unnamed Signals in this System</b>	All signals in the selected system, whose <b>Signal name</b> parameter is empty
<b>Unnamed Signals from Here Down</b>	All signals in the selected system and its subsystems, whose <b>Signal name</b> parameter is empty

## Examples

To learn how to use the Fixed-Point Tool, see “Tutorial: Feedback Controller Simulation” in the Simulink Fixed Point documentation.

## See Also

autofixexp, showfixptsimerrors, showfixptsimranges

---

<b>Purpose</b>	Get pathname of current block
<b>Syntax</b>	<pre>gcb gcb('sys')</pre>
<b>Description</b>	<p>gcb returns the full block pathname of the current block in the current system.</p> <p>gcb('sys') returns the full block pathname of the current block in the specified system.</p> <p>The current block is one of these:</p> <ul style="list-style-type: none"><li>• During editing, the current block is the block most recently clicked.</li><li>• During simulation of a system that contains S-Function blocks, the current block is the S-Function block currently executing its corresponding MATLAB function.</li><li>• During callbacks, the current block is the block whose callback routine is being executed.</li><li>• During evaluation of the MaskInitialization string, the current block is the block whose mask is being evaluated.</li></ul>
<b>Examples</b>	<p>This command returns the path of the most recently selected block.</p> <pre>gcb ans =     clutch/Locked/Inertia</pre> <p>This command gets the value of the Gain parameter of the current block.</p> <pre>get_param(gcb, 'Gain') ans =     1/(Iv+Ie)</pre>
<b>See Also</b>	gcbh, gcs

# gcbh

---

**Purpose** Get handle of current block

**Syntax** gcbh

**Description** gcbh returns the handle of the current block in the current system. You can use this command to identify or address blocks that have no parent system. The command should be most useful to blockset authors.

**Examples** This command returns the handle of the most recently selected block.

```
gcbh
ans =
    281.0001
```

**See Also** gcb

---

<b>Purpose</b>	Get pathname of current system
<b>Syntax</b>	<code>gcs</code>
<b>Description</b>	<p><code>gcs</code> returns the full pathname of the current system.</p> <p>The current system is one of these:</p> <ul style="list-style-type: none"><li>• During editing, the current system is the system or subsystem most recently clicked.</li><li>• During simulation of a system that contains S-Function blocks, the current system is the system or subsystem containing the S-Function block that is currently being evaluated.</li><li>• During callbacks, the current system is the system containing any block whose callback routine is being executed.</li><li>• During evaluation of the <code>MaskInitialization</code> string, the current system is the system containing the block whose mask is being evaluated.</li></ul> <p>The current system is always the current model or a subsystem of the current model. Use <code>bdroot</code> to get the current model.</p>
<b>Examples</b>	<p>This example returns the path of the system that contains the most recently selected block.</p> <pre>gcs ans =     clutch/Locked</pre>
<b>See Also</b>	<code>bdroot</code> , <code>gcb</code>

# get\_param

---

**Purpose** Get system and block parameter values

**Syntax**

```
get_param('obj', 'parameter')
get_param( { objects }, 'parameter')
get_param(handle, 'parameter')
get_param(0, 'parameter')
get_param('obj', 'ObjectParameters')
get_param('obj', 'DialogParameters')
```

**Description**

`get_param('obj', 'parameter')`, where 'obj' is a system or block pathname, returns the value of the specified parameter. Some parameters are case-sensitive, and some are not. To prevent problems, treat all parameters as case-sensitive.

`get_param( { objects }, 'parameter')` accepts a cell array of full path specifiers, enabling you to get the values of a parameter common to all objects specified in the cell array.

`get_param(handle, 'parameter')` returns the specified parameter of the object whose handle is handle.

`get_param(0, 'parameter')` returns the current value of a Simulink session parameter or the default value of a model or block parameter.

`get_param('obj', 'ObjectParameters')` returns a structure that describes obj's parameters. Each field of the returned structure corresponds to a particular parameter and has the parameter's name. For example, the Name field corresponds to the object's Name parameter. Each parameter field itself contains three fields, Name, Type, and Attributes, that specify the parameter's name (for example, 'Gain'), data type (for example, string), and attributes (for example, read-only), respectively.

`get_param('obj', 'DialogParameters')` returns a cell array containing the names of the dialog parameters of the specified block.

Chapter 8, “Model and Block Parameters” contains lists of model and block parameters.



**Examples**

This command returns the value of the Gain parameter for the Inertia block in the Requisite Friction subsystem of the clutch system.

```
get_param('clutch/Requisite Friction/Inertia','Gain')
ans =
    1/(Iv+Ie)
```

These commands display the block types of all blocks in the mx + b system (the current system), described in “Masked Subsystem Example” in *Using Simulink*.

```
blks = find_system(gcs, 'Type', 'block');
listblks = get_param(blks, 'BlockType')

listblks =

    'SubSystem'
    'Inport'
    'Constant'
    'Gain'
    'Sum'
    'Outputport'
```

This command returns the name of the currently selected block.

```
get_param(gcf, 'Name')
```

The following commands get the attributes of the currently selected block's Name parameter.

```
p = get_param(gcf, 'ObjectParameters');
a = p.Name.Attributes

ans =

    'read-write'    'always-save'
```

## get\_param

---

The following command gets the dialog parameters of a Sine Wave block.

```
p = get_param('untitled/Sine Wave', 'DialogParameters')
p =
    SineType: [1x1 struct]
    TimeSource: [1x1 struct]
    Amplitude: [1x1 struct]
    Bias: [1x1 struct]
    Frequency: [1x1 struct]
    Phase: [1x1 struct]
    Samples: [1x1 struct]
    Offset: [1x1 struct]
    SampleTime: [1x1 struct]
    VectorParamsID: [1x1 struct]
```

**See Also**      find\_system, set\_param

<b>Purpose</b>	Get model's active configuration set or configuration reference
<b>Syntax</b>	<code>myConfigObj = getActiveConfigSet('model')</code>
<b>Arguments</b>	<i>model</i> The name of an open model, or gcs to specify the current model
<b>Description</b>	<code>getActiveConfigSet</code> returns the configuration set or configuration reference (configuration object) that is the active configuration object of ' <i>model</i> '.
<b>Example</b>	The following example returns the active configuration object of the current model. The code is the same whether the object is a configuration set or configuration reference.  <pre>myConfigObj = getActiveConfigSet(gcs);</pre>
<b>See Also</b>	“Configuration Sets”, “Referencing Configuration Sets” <code>attachConfigSet</code> , <code>attachConfigSetCopy</code> , <code>closeDialog</code> , <code>detachConfigSet</code> , <code>getConfigSet</code> , <code>getConfigSets</code> , <code>openDialog</code> , <code>setActiveConfigSet</code>

# getCallbackAnnotation

---

**Purpose** Get information about annotation

**Syntax** `getCallbackAnnotation`

**Description** `getCallbackAnnotation` is intended to be invoked by annotation callback functions. If it is invoked from an annotation callback function, it returns an instance of `Simulink.Annotation` class that represents the annotation associated with the callback function. The callback function can then use the instance to get and set the annotation's properties, such as its text, font and color. If this function is not invoked from an annotation callback function, it returns nothing, i.e., `[]`.

<b>Purpose</b>	Get one of model's configuration sets or configuration references
<b>Syntax</b>	<pre>myConfigObj = getConfigSet('model', 'configObjName')</pre>
<b>Arguments</b>	<p><i>model</i> The name of an open model, or gcs to specify the current model</p> <p><i>configObjName</i> The name of a configuration set (Simulink.ConfigSet) or configuration reference (Simulink.ConfigSetRef)</p>
<b>Description</b>	getConfigSet returns the configuration set or configuration reference (configuration object) that is attached to <i>model</i> and is named <i>configObjName</i> . If no such object exists, an error occurs.
<b>Example</b>	<p>The following example returns the configuration object that is named DevConfig and attached to the current model. The code is the same whether DevConfig is a configuration set or configuration reference.</p> <pre>myConfigObj = getConfigSet(gcs, 'DevConfig');</pre>
<b>See Also</b>	“Configuration Sets”, “Referencing Configuration Sets” attachConfigSet, attachConfigSetCopy, closeDialog, detachConfigSet, getActiveConfigSet, getConfigSets, openDialog, setActiveConfigSet

# getConfigSets

---

**Purpose** Get names of all of model's configuration sets or configuration references

**Syntax** `myConfigObjNames = getConfigSets('model')`

**Arguments** `model`  
The name of an open model, or `gcs` to specify the current model

**Description** `getConfigSets` returns a cell array of strings specifying the names of all configuration sets and configuration references (configuration objects) attached to `'model'`.

**Example** The following example obtains the names of the configuration objects attached to the current model.

```
myConfigObjNames = getConfigSets(gcs)
```

**See Also** “Configuration Sets”, “Referencing Configuration Sets”  
`attachConfigSet`, `attachConfigSetCopy`, `closeDialog`,  
`detachConfigSet`, `getActiveConfigSet`, `getConfigSet`, `openDialog`,  
`setActiveConfigSet`

**Purpose** Get pathname of block or line

**Syntax** path=getfullname(handle)

**Description** path=getfullname(handle) returns the full pathname of the block or line specified by handle.

**Examples** getfullname(gcb) returns the pathname of the block currently selected in the model editor's window.

The following code returns the pathname of the line currently selected in the model editor's window.

```
line = find_system(gcs, 'SearchDepth', 1, 'FindAll', 'on', ...
    'Type', 'line', 'Selected', 'on');
path = getfullname(list);
```

**See Also** gcb, find\_system

# legacy\_code

---

**Purpose** Use Legacy Code Tool

**Syntax**

```
legacy_code('help')
specs = legacy_code('initialize')
legacy_code('sfcn_cmex_generate', specs)
legacy_code('compile', specs, compilerOptions)
legacy_code('slblock_generate', specs, modelName)
legacy_code('sfcn_tlc_generate', specs)
legacy_code('rtwmakecfg_generate', specs)
legacy_code('backward_compatibility')
```

**Arguments** *specs*  
A structure with the following fields

Field	Description
<b>Name the S-function</b>	
SFunctionName (Required)	A string specifying a name for the S-function to be generated by the Legacy Code Tool.
<b>Define Legacy Code Tool Function Specifications</b>	
InitializeConditionsFcnSpec	A nonempty string specifying a reentrant function that the S-function calls to initialize and reset states. You must declare this function by using tokens that Simulink can interpret as explained in “Declaring Legacy Code Tool Function Specifications”.
OutputFcnSpec	A nonempty string specifying the function that the S-function calls at each time step. You must declare this function by using tokens that Simulink can interpret as explained in “Declaring Legacy Code Tool Function Specifications”.



<b>Field</b>	<b>Description</b>
StartFcnSpec	A string specifying the function that the S-function calls when it begins execution. This function can access S-function parameter arguments only. You must declare this function by using tokens that Simulink can interpret as explained in “Declaring Legacy Code Tool Function Specifications”.
TerminateFcnSpec	A string specifying the function that the S-function calls when it terminates execution. This function can access S-function parameter arguments only. You must declare this function by using tokens that Simulink can interpret as explained in “Declaring Legacy Code Tool Function Specifications”.
<b>Define Compilation Resources</b>	
HeaderFiles	A cell array of strings specifying the file names of header files required for compilation.
SourceFiles	A cell array of strings specifying source files required for compilation. You can specify the source files using absolute or relative pathnames.
HostLibFiles	A cell array of strings specifying library files required for host compilation. You can specify the library files using absolute or relative pathnames.
TargetLibFiles	A cell array of strings specifying library files required for target (that is, standalone) compilation. You can specify the library files using absolute or relative pathnames.
IncPaths	A cell array of strings specifying directories containing header files. You can specify the directories using absolute or relative pathnames.
SrcPaths	A cell array of strings specifying directories containing source files. You can specify the directories using absolute or relative pathnames.

# legacy\_code

---

Field	Description
LibPaths	A cell array of strings specifying directories containing host and target library files. You can specify the directories using absolute or relative pathnames.
<b>Specify a Sample Time</b>	
SampleTime	<p>One of the following:</p> <p>'inherited' (default) — Sample time is inherited from the source block.</p> <p>'parameterized' — Sample time is represented as a tunable parameter. Generated code can access the parameter by calling MEX API functions, such as <code>mxGetPr</code> or <code>mxGetData</code>.</p> <p>Fixed — Sample time that you explicitly specify. For information on how to specify sample time, see “Specifying Sample Time”.</p> <p>If you specify this field, you must specify it last.</p>

Field	Description
<b>Define S-Function Options</b>	
Options	<p>A structure that controls S-function options. The structure's fields include:</p> <p><code>isMacro</code> — A logical value specifying whether the legacy code is a C macro. By default, its value is false (0).</p> <p><code>isVolatile</code> — A logical value specifying the setting of the S-function <code>SS_OPTION_NONVOLATILE</code> option (see <code>SS_OPTION_NONVOLATILE</code>). By default, its value is true (1).</p> <p><code>canBeCalledConditionally</code> — A logical value specifying the setting of the S-function <code>SS_OPTION_CAN_BE_CALLED_CONDITIONALLY</code> option (see <code>SS_OPTION_CAN_BE_CALLED_CONDITIONALLY</code>). By default, its value is true (1).</p> <p><code>useTlcWithAccel</code> — A logical value specifying the setting of the S-function <code>SS_OPTION_USE_TLC_WITH_ACCELERATOR</code> option (see <code>SS_OPTION_USE_TLC_WITH_ACCELERATOR</code>). By default, its value is true (1).</p> <p><code>language</code> — A string specifying either 'C' or 'C++' as the target language of the S-function that Legacy Code Tool will produce. By default, its value is 'C'.</p>

*modelName*

The name of a Simulink model into which Legacy Code Tool is to insert the masked S-function block generated when you specify `legacy_code` with the action string 'slblock\_generate'. If you omit this argument, the block appears in an empty model editor window.

**Description**

The `legacy_code` function creates a MATLAB structure for registering the specification for existing C or C++ code and the S-function being

generated. In addition, the function can generate, compile and link, and create a masked block for the specified S-function. Other options include generating

- A TLC file for simulation in Accelerator mode or code generation
- An `rtwmakecfg.m` file that you can customize to specify dependent source and header files that reside in a different directory than that of the generated S-function

`legacy_code('help')` displays instructions for using Legacy Code Tool.

`specs = legacy_code('initialize')` initializes the Legacy Code Tool data structure, `specs`, which registers characteristics of existing C or C++ code and properties of the S-function that the Legacy Code Tool generates.

`legacy_code('sfcn_cmex_generate', specs)` generates an S-function source file as specified by the Legacy Code Tool data structure, `specs`.

`legacy_code('compile', specs, compilerOptions)` compiles and links the S-function generated by the Legacy Code Tool based on the data structure, `specs`, and any compiler options that you might specify. The following examples show how to specify no options, one option, and multiple options:

```
legacy_code('compile', s);
legacy_code('compile', s, '-DCOMPILER_VALUE1=1');
legacy_code('compile', s, ...
            {'-DCOMPILER_VALUE1=1', '-DCOMPILER_VALUE2=2', '-DCOMPILER_VALUE3=3'}
```

`legacy_code('slblock_generate', specs, modelName)` generates a masked S-Function block for the S-function generated by the Legacy Code Tool based on the data structure, `specs`. The block appears in the Simulink model specified by `modelName`. If you omit `modelName`, the block appears in an empty model editor window.

`legacy_code('sfcn_tlc_generate', specs)` generates a TLC file for the S-function generated by the Legacy Code Tool based on the data structure, *specs*. This option is relevant if you want to

- Force Accelerator mode in Simulink to use the TLC inlining code of the generated S-function. See the description of the `ssSetOptions` `SimStruct` function and `SS_OPTION_USE_TLC_WITH_ACCELERATOR` S-function option for more information.
- Use Real-Time Workshop to generate code from your Simulink model. See “Using the Legacy Code Tool to Automate the Generation of Files for Fully Inlined S-Functions” for more information.

`legacy_code('rtwmakecfg_generate', specs)` generates an `rtwmakecfg.m` file for the S-function generated by the Legacy Code Tool based on the data structure, *specs*. This option is relevant only if you use Real-Time Workshop to generate code from your Simulink model. See “Using the `rtwmakecfg.m` API” and “Using the Legacy Code Tool to Automate the Generation of Files for Fully Inlined S-Functions” in the Real-Time Workshop documentation for more information.

`legacy_code('backward_compatibility')` automatically updates syntax for using Legacy Code Tool, as made available from MATLAB Central in releases before R2006b, to the supported syntax described in this reference page and in “Integrating Existing C Functions into Simulink Models with the Legacy Code Tool” in *Writing S-Functions*.

## See Also

- “Integrating Existing C Functions into Simulink Models with the Legacy Code Tool” in the Writing S-Functions documentation
- “Using the Legacy Code Tool to Automate the Generation of Files for Fully Inlined S-Functions” in the Real-Time Workshop documentation

# libinfo

---

**Purpose** Get information about library blocks referenced by model

**Syntax** `libdata = libinfo('sys')`

**Description** `libdata = libinfo('sys')` returns information about library blocks referenced by `sys` and all of the systems underneath it. The command returns an array of structures that describes each library block referenced by the model. Each structure has the following fields:

- **Block**  
Path of the link to the library block.
- **Library**  
Name of the library containing the referenced block.
- **ReferenceBlock**  
Path of the library block.
- **LinkStatus**  
Value of the `LinkStatus` parameter for the link to the library block.

This command also accepts search constraints as additional arguments. For instance:

```
libdata=libinfo(Sys,'FollowLinks','off')
```

See `find_system` for more information.

## Purpose

Extract continuous- or discrete-time linear state-space model of system around operating point

## Syntax

```
argout = linmod('sys');  
argout = linmod('sys',x,u);  
argout = linmod('sys', x, u, para);  
argout = linmod('sys', x, u, 'v5');  
argout = linmod('sys', x, u, para, 'v5');  
argout = linmod('sys', x, u, para, xpert, upert, 'v5');  
  
argout = dlinmod('sys', Ts, x, u);  
argout = dlinmod('sys',Ts, x, u, para, 'v5');  
argout = dlinmod('sys',Ts, x, u, para, xpert, upert, 'v5');  
  
argout = linmod2('sys', x, u);  
argout = linmod2('sys', x, u, para);  
  
argout = linmodv5('sys');  
argout = linmodv5('sys',x,u);  
argout = linmodv5('sys', x, u, para);  
argout = linmod('sys', x, u, para, xpert, upert);
```

# linmod, dlinmod, linmod2, linmodv5

---

## Arguments

sys	The name of the Simulink system from which the linear model is to be extracted.
x and u	The state and the input vectors. If specified, they set the operating point at which the linear model is to be extracted. When a model has model references using the Model block, you must use the Simulink structure format to specify x. To extract the x structure from the model, use the following command:  <pre>x = Simulink.BlockDiagram.getInitialState('sys');</pre> You can then change the operating point values within this structure by editing <code>x.signals.values</code> .
Ts	Sample time of the discrete-time linearized model
'v5'	An optional argument that invokes the perturbation algorithm created prior to MATLAB 5.3. Invoking this optional argument is equivalent to calling <code>linmodv5</code> .



para

A three-element vector of optional arguments:

- para(1) — Perturbation value of delta, the value used to perform the perturbation of the states and the inputs of the model. This is valid for linearizations using the 'v5' flag. The default value is 1e-05.
- para(2) — Linearization time. For blocks that are functions of time, this parameter can be set with a nonnegative value of t giving the time at which Simulink evaluates the blocks when linearizing a model. The default value is 0.
- para(3) — Set para(3)=1 to remove extra states associated with blocks that have no path from input to output. The default value is 0.

# linmod, dlinmod, linmod2, linmodv5

---

xpert and  
upert

The perturbation values used to perform the perturbation of all the states and inputs of the model. The default values are

```
xpert = para(1) + 1e-3*para(1)*abs(x)
upert = para(1) + 1e-3*para(1)*abs(u)
```

When a model has model references using the Model block, you must use the Simulink structure format to specify xpert. To extract the xpert structure, use the following command:

```
xpert = Simulink.BlockDiagram.getInitialState('sys');
```

You can then change the perturbation values within this structure by editing `xpert.signals.values`.

The perturbation input arguments are only available when invoking the perturbation algorithm created prior to MATLAB 5.3, either by calling `linmodv5` or specifying the 'v5' input argument to `linmod`.

*argout*

`linmod`, `dlinmod`, and `linmod2` all return state-space, transfer function, and MATLAB data structure representations of the linearized system, depending on how you specify the output (left-hand) side of the equation. Using `linmod` as an example:

- `[A,B,C,D] = linmod('sys', x, u)` obtains the linearized model of `sys` around an operating point with the specified state variables `x` and the input `u`. If you omit `x` and `u`, the default values are zero.
- `[num, den] = linmod('sys', x, u)` returns the linearized model in transfer function form.
- `sys_struct = linmod('sys', x, u)` returns a structure that contains the linearized model, including state names, input and output names, and information about the operating point.

## Description

`linmod` and `dlinmod` compute a linear state space model by linearizing each block in a model individually. `linmod2` computes a linear state-space model by perturbing the model inputs and model states, and uses an advanced algorithm to reduce truncation error. `linmodv5` computes a linear state space model using the full model perturbation algorithm created prior to MATLAB 5.3.

`linmod` obtains linear models from systems of ordinary differential equations described as Simulink models. Inputs and outputs are denoted in Simulink block diagrams using Inport and Outport blocks.

The default algorithm uses preprogrammed analytic block Jacobians for most blocks which should result in more accurate linearization than numerical perturbation of block inputs and states. A list of blocks that have preprogrammed analytic Jacobians is available in the Simulink Control Design documentation along with a discussion of the block-by-block analytic algorithm for linearization. If you do not have Simulink Control Design installed, you can access the documentation on the MathWorks Web site at <http://www.mathworks.com/access/helpdesk/help/toolbox/slcontrol/>.

The default algorithm also allows for special treatment of problematic blocks such as the Transport Delay and the Quantizer. See the mask dialog of these blocks for more information and options.

## Discrete-Time System Linearization

The function `dlinmod` can linearize discrete, multirate, and hybrid continuous and discrete systems at any given sampling time. Use the same calling syntax for `dlinmod` as for `linmod`, but insert the sample time at which to perform the linearization as the second argument. For example,

```
[Ad,Bd,Cd,Dd] = dlinmod('sys', Ts, x, u);
```

produces a discrete state-space model at the sampling time  $T_s$  and the operating point given by the state vector  $x$  and input vector  $u$ . To obtain a continuous model approximation of a discrete system, set  $T_s$  to 0.

# linmod, dlinmod, linmod2, linmodv5

---

For systems composed of linear, multirate, discrete, and continuous blocks, `dlinmod` produces linear models having identical frequency and time responses (for constant inputs) at the converted sampling time  $T_s$ , provided that

- $T_s$  is an integer multiple of all the sampling times in the system.
- The system is stable.

For systems that do not meet the first condition, in general the linearization is a time-varying system, which cannot be represented with the  $[A,B,C,D]$  state-space model that `dlinmod` returns.

Computing the eigenvalues of the linearized matrix  $A_d$  provides an indication of the stability of the system. The system is stable if  $T_s > 0$  and the eigenvalues are within the unit circle, as determined by this statement:

$$\text{all}(\text{abs}(\text{eig}(A_d))) < 1$$

Likewise, the system is stable if  $T_s = 0$  and the eigenvalues are in the left half plane, as determined by this statement:

$$\text{all}(\text{real}(\text{eig}(A_d))) < 0$$

When the system is unstable and the sample time is not an integer multiple of the other sampling times, `dlinmod` produces  $A_d$  and  $B_d$  matrices, which can be complex. The eigenvalues of the  $A_d$  matrix in this case still, however, provide a good indication of stability.

You can use `dlinmod` to convert the sample times of a system to other values or to convert a linear discrete system to a continuous system or vice versa.

You can find the frequency response of a continuous or discrete system by using the `bode` command.

## Notes

By default, the system time is set to zero. For systems that are dependent on time, you can set the variable `para` to a two-element

vector, where the second element is used to set the value of  $t$  at which to obtain the linear model.

The ordering of the states from the nonlinear model to the linear model is maintained. For Simulink systems, a string variable that contains the block name associated with each state can be obtained using

```
[sizes,x0,xstring] = sys
```

where `xstring` is a vector of strings whose  $i$ th row is the block name associated with the  $i$ th state. Inputs and outputs are numbered sequentially on the diagram.

For single-input multi-output systems, you can convert to transfer function form using the routine `ss2tf` or to zero-pole form using `ss2zp`. You can also convert the linearized models to LTI objects using `ss`. This function produces an LTI object in state-space form that can be further converted to transfer function or zero-pole-gain form using `tf` or `zpk`.

The default algorithms in `linmod` and `dlinmod` handle Transport Delay blocks by replacing the linearization of the blocks with a Pade approximation. For the 'v5' algorithm, linearization of a model that contains Derivative or Transport Delay blocks can be troublesome. For more information, see “Linearizing Models” in *Using Simulink*.

# load\_system

---

**Purpose** Invisibly load Simulink model

**Syntax** `load_system('sys')`

**Description** `load_system('sys')` loads 'sys', where sys is the name of a Simulink model, into memory without making its model window visible.

**Examples** The command

```
load_system('vdp')
```

loads the vdp sample model into memory.

**See Also** `close_system`, `open_system`

**Purpose**

Execute particular phase of simulation of model

**Syntax**

```
[sys,x0,str,ts] = model([],[],[],'sizes');  
[sys,x0,str,ts] = model([],[],[],'compile');  
outputs = model(t,x,u,'outputs');  
derivs = model(t,x,u,'derivs');  
dstates = model(t,x,u,'update');  
model([],[],[],'term');
```

**Description**

The `model` command executes a specific phase of the simulation of a Simulink model whose name is `model`. The command's last (flag) argument specifies the phase of the simulation to be executed. See “Simulating Dynamic Systems” for a description of the steps that Simulink uses to simulate a model.

This command is intended to allow linear analysis and other M-file program-based tools to run a simulation step by step, gathering information about the model's states and outputs at each step. It is not intended to be used to run a model step by step, for example, to debug a model. Use the Simulink debugger if you need to examine intermediate results to debug a model.

# model

---

## Arguments

sys	Vector of model size data: <ul style="list-style-type: none"><li>• sys (1) = number of continuous states</li><li>• sys (2) = number of discrete states</li><li>• sys (3) = number of outputs</li><li>• sys (4) = number of inputs</li><li>• sys (5) = reserved</li><li>• sys (6) = direct-feedthrough flag (1 = yes, 0 = no)</li><li>• sys (7) = number of sample times (= number of rows in ts)</li></ul>
x0	Vector containing the initial conditions of the system's states
str	Vector of names of the blocks associated with the model's states. The state names and initial conditions appear in the same order in str and x0, respectively.
ts	An $m$ -by-2 matrix containing the sample time (period, offset) information
outputs	Outputs of the model at time step $t$ .
derivs	Derivatives of the continuous states of the model at time $t$ .
dstates	Discrete states of the model at time $t$ .
t	Time step
x	State vector



u	Inputs
flag	<p data-bbox="817 314 1270 374">String that indicates the simulation phase to be executed:</p> <ul data-bbox="817 409 1334 1124" style="list-style-type: none"> <li data-bbox="817 409 1334 534">• 'sizes' executes the size computation phase of the simulation. This phase determines the sizes of the model's inputs, outputs, state vector, etc.</li> <li data-bbox="817 552 1334 774">• 'compile' executes the compilation phase of the simulation. The compilation phase propagates signal and sample time attributes. It is equivalent to selecting the <b>Update Diagram (Ctrl-D)</b> option from the Simulink <b>Edit</b> menu.</li> <li data-bbox="817 791 1334 852">• 'update' computes the next values of the model's discrete states.</li> <li data-bbox="817 869 1334 930">• 'outputs' computes the outputs of the model's blocks at time t.</li> <li data-bbox="817 947 1334 1043">• 'derivs' computes the derivatives of the model's continuous states at time step t.</li> <li data-bbox="817 1060 1334 1124">• 'term' causes Simulink to terminate simulation of the model.</li> </ul>

### Examples

This command executes the compilation phase of the vdp model that comes with Simulink.

```
vdp([], [], [], 'compile')
```

The following command terminates the simulation initiated in the previous example.

```
vdp([], [], [], 'term')
```

---

**Note** You must always terminate simulation of the model by invoking the model command with the 'term' command. Simulink does not let you close the model until you have terminated the simulation.

---

## See Also

`sim`

**Purpose** Open Model Advisor

**Syntax** `modeladvisor(model)`

**Description** `modeladvisor(model)` opens the Model Advisor (see the “Consulting Model Advisor” in *Using Simulink*) on the model or subsystem specified by `model`, where `model` is a path or handle to the model or subsystem. If the specified model or subsystem is not open, this command opens it.

**Examples** The command

```
modeladvisor('vdp')
```

opens the Model Advisor on the vdp demo model.

The command

```
modeladvisor('f14/Aircraft Dynamics Model')
```

opens the Model Advisor on the Aircraft Dynamics Model subsystem of the f14 demo model. The command

```
modeladvisor(gcs)
```

opens the Model Advisor on the currently selected subsystem.

The command

```
modeladvisor(bdroot)
```

opens the Model Advisor on the currently selected model.

# new\_system

---

**Purpose** Create empty Simulink system

**Syntax**

```
new_system('sys')
new_system('sys', 'Model')
new_system('sys', 'Model', 'subsystem_path')
new_system('sys', 'Model', 'ErrorIfShadowed')
new_system('sys', 'Library')
```

**Description** `new_system('sys')` or `new_system('sys', 'Model')` creates an empty system where 'sys' is the name of the new system. This command displays an error if 'sys' is a MATLAB keyword, 'simulink', or more than 63 characters long.

`new_system('sys', 'Model', 'subsystem_path')` creates a system from a subsystem where 'subsystem\_path' is the full path of the subsystem. The model that contains the subsystem must be open when this command is executed.

`new_system('sys', 'Model', 'ErrorIfShadowed')` creates an empty system having the specified name. This command generates an error if another model, M-file, or variable of the same name exists on the MATLAB path or workspace.

`new_system('sys', 'Library')` creates an empty library.

---

**Note** The `new_system` command does not open the window of the system or library that it creates.

---

See Chapter 8, “Model and Block Parameters” for a list of the default parameter values for the new system.

**Examples** This command creates a new system named 'mysys'.

```
new_system('mysys')
```

The command

```
new_system('mysys','Library')
```

creates, but does not open, a new library named 'sys'.

The command

```
new_system('vdp','Model','ErrorIfShadowed')
```

returns an error because 'vdp' is the name of a model on the MATLAB path.

The commands

```
load_system('f14')
new_system('mycontroller','Model','f14/Controller')
```

create a new model named `mycontroller` that has the same contents as does the subsystem named `Controller` in the `f14` demo model.

### See Also

`close_system`, `open_system`, `save_system`

# num2fixpt

---

**Purpose** Convert number to nearest value representable by specified fixed-point data type

**Syntax** `outValue = num2fixpt(OrigValue, FixPtDataType, FixPtScaling, RndMeth, DoSatur)`

**Description** `num2fixpt(OrigValue, FixPtDataType, FixPtScaling, RndMeth, DoSatur)` returns the result of converting `OrigValue` to the nearest value representable by the fixed-point data type `FixPtDataType`. Both `OrigValue` and `outValue` are of data type `double`. As illustrated in the example that follows, you can use `num2fixpt` to investigate quantization error that might result from converting a number to a fixed-point data type. The arguments of `num2fixpt` include:

- |                            |  |
|----------------------------|--|
| <code>OrigValue</code>     | Value to be converted to a fixed-point representation. Must be specified using a double data type.   |
| <code>FixPtDataType</code> | The fixed-point data type used to convert <code>OrigValue</code> .   |
| <code>FixPtScaling</code>  | Scaling of the output in either <code>Slope</code> or <code>[Slope Bias]</code> format. If <code>FixPtDataType</code> does not specify a generalized fixed-point data type using the <code>sfix</code> or <code>ufix</code> command, <code>FixPtScaling</code> is ignored. |

RndMeth	Rounding technique used if the fixed-point data type lacks the precision to represent OrigValue. If FixPtDataType specifies a floating-point data type using the float command, RndMeth is ignored. Valid values are Zero, Nearest, Ceiling, or Floor (the default).
DoSatur	Indicates whether the output should be saturated to the minimum or maximum representable value upon underflow or overflow. If FixPtDataType specifies a floating-point data type using the float command, DoSatur is ignored. Valid values are on or off (the default).

## Examples

Suppose you wish to investigate the quantization effect associated with representing the real-world value 9.875 as a signed, 8-bit fixed-point number. The command

```
num2fixpt(9.875, sfix(8), 2^-1)
```

```
ans =
```

```
9.500000000000000
```

reveals that a slope of  $2^{-1}$  results in a quantization error of 0.375. The command

```
num2fixpt(9.875, sfix(8), 2^-2)
```

```
ans =
```

```
9.750000000000000
```

# num2fixpt

---

demonstrates that a slope of  $2^{-2}$  reduces the quantization error to 0.125. But a slope of  $2^{-3}$ , as used in the command

```
num2fixpt(9.875, sfix(8), 2^-3)
```

```
ans =
```

```
9.875000000000000
```

eliminates the quantization error entirely.

## See Also

`fixptbestexp`, `fixptbestprec`



**Purpose** Open Simulink system window or block dialog box

**Syntax**

```
open_system('sys')
open_system('blk')
open_system('blk', 'force')
open_system('blk', 'parameter')
open_system('blk', 'mask')
open_system('blk', 'OpenFcn')
open_system('sys', 'destsys', 'replace')
open_system('sys', 'destsys', 'reuse')
```

**Description** `open_system('sys')` opens the specified system or subsystem window, where 'sys' is the name of a model on the MATLAB path, the fully qualified pathname of a model, or the relative pathname of a subsystem of an already open system (for example, engine/Combustion). On UNIX, the fully qualified pathname of a model can start with a tilde (~), signifying your home directory.

`open_system('blk')`, where 'blk' is a full block pathname, opens the dialog box associated with the specified block. If the block's `OpenFcn` callback parameter is defined, the routine is evaluated.

`open_system('blk', 'force')`, where 'blk' is a full pathname or a masked system, looks under the mask of the specified system. This command is equivalent to using the **Look Under Mask** menu item.

`open_system('blk', 'parameter')` opens this block's parameter dialog box.

`open_system('sys', 'mask')` opens this block's mask.

`open_system('blk', 'OpenFcn')` runs this block's open function.

`open_system('sys', 'destsys', 'replace')` replaces the window of the previously opened system `destsys` with the window of the subsystem `sys` opened by this command. The location of the new window is determined by the location of the destination system `destsys` while the size of the window will match that used by `sys`.

# open\_system

---

`open_system('sys', 'destsys', 'reuse')` reuses the window of the previously opened system `destsys` to display the contents of the subsystem `sys` opened by this command. In this case, `sys` will be scaled to fit within the window size determined by the destination system `destsys`.

---

**Note** Use the MATLAB `sprintf` command to insert carriage return or line feed characters into paths passed to the `open_system` command. For example, the path to the Aircraft Dynamics Model subsystem of the f14 demo model contains line feeds. To open the subsystem, enter the following command at the MATLAB command line:

```
open_system(['f14/Aircraft' sprintf('\n') 'Dynamics' sprintf('\n') 'Model'])
```

---

## Examples

This command opens the controller system in its default screen location.

```
open_system('controller');
```

This command opens the block dialog box for the Gain block in the controller system.

```
open_system('controller/Gain');
```

This command opens `f14` into the `f14/Controller` window using `reuse` mode.

```
open_system('f14', 'f14/Controller', 'reuse');
```

Suppose that `mymodel` contains a masked subsystem, `A`, and a block, `B`, whose `OpenFcn` contains the following lines:

```
open_system('mymodel/B', 'parameter');  
open_system('mymodel/A', 'mask');
```

Then opening block B causes both the parameter dialog box for B and the mask dialog box for A to appear.

This command opens f14 and vdp with a vectorize operation.

```
open_system( {'f14', 'vdp'} );
```

Empty strings are treated as a no operation, as shown in the following example. This example assumes f14 is already open.

```
open_system( {'f14', 'f14/Controller', 'f14' }, ...  
            {'', '', 'f14/Controller' }, ...  
            {'', '', 'replace' } );
```

## See Also

close\_system, load\_system, new\_system, save\_system

# openDialog

---

<b>Purpose</b>	Open configuration parameters dialog
<b>Syntax</b>	<code>openDialog(<i>configObj</i>)</code>
<b>Arguments</b>	<i>configObj</i> A configuration set ( <code>Simulink.ConfigSet</code> ) or configuration reference ( <code>Simulink.ConfigSetRef</code> )
<b>Description</b>	<code>openDialog</code> opens a configuration parameters dialog box. If <i>configObj</i> is a configuration set, the dialog box displays the configuration set. If <i>configObj</i> is a configuration reference, the dialog box displays the referenced configuration set, or generates an error if the reference does not specify a valid configuration set. If the dialog box is already open, its window becomes selected.
<b>Example</b>	The following example opens a configuration parameters dialog box that shows the current parameters for the current model. The parameter values derive from the active configuration set or configuration reference (configuration object). The code is the same in either case; the only difference is which type of configuration object is currently active. <pre>myConfigObj = getActiveConfigSet(gcs); openDialog(myConfigObj);</pre>
<b>See Also</b>	“Configuration Sets”, “Referencing Configuration Sets” <code>attachConfigSet</code> , <code>attachConfigSetCopy</code> , <code>closeDialog</code> , <code>detachConfigSet</code> , <code>getActiveConfigSet</code> , <code>getConfigSet</code> , <code>getConfigSets</code> , <code>setActiveConfigSet</code>

**Purpose**

Replace blocks in Simulink model

**Syntax**

```
replace_block('sys', 'blk1', 'blk2', 'noprompt')  
replace_block('sys', 'Parameter', 'value', 'blk', ...)
```

**Description**

`replace_block('sys', 'blk1', 'blk2')` replaces all blocks in 'sys' having the block or mask type 'blk1' with 'blk2'.

- If 'blk2' is a Simulink built-in block, only the block name is necessary.
- If 'blk' is in another system, its full block pathname is required.
- If 'noprompt' is omitted, Simulink displays a dialog box that asks you to select matching blocks before making the replacement. Specifying the 'noprompt' argument suppresses the dialog box from being displayed.
- If a return variable is specified, the paths of the replaced blocks are stored in that variable.

`replace_block('sys', 'Parameter', 'value', ..., 'blk')` replaces all blocks in 'sys' having the specified values for the specified parameters with 'blk'. You can specify any number of parameter name/value pairs. For information on block parameters, see Chapter 8, “Model and Block Parameters”

---

**Note** Because it may be difficult to undo the changes this command makes, it is a good idea to save your system first.

---

**Examples**

This command replaces all Gain blocks in the f14 system with Integrator blocks and stores the paths of the replaced blocks in RepNames. Simulink lists the matching blocks in a dialog box before making the replacement.

# replace\_block

---

```
RepNames = replace_block('f14','Gain','Integrator')
```

This command replaces all blocks in the Unlocked subsystem in the clutch system having a Gain of 'bv' with the Integrator block. Simulink displays a dialog box listing the matching blocks before making the replacement.

```
replace_block('clutch/Unlocked','Gain','bv','Integrator')
```

This command replaces the Gain blocks in the f14 system with Integrator blocks but does not display the dialog box.

```
replace_block('f14','Gain','Integrator','noprompt')
```

This command replaces the Small\_Wheel subsystem in the wheel\_analysis model with the Large\_Wheel subsystem from the wheels library.

```
replace_block('wheel_analysis','Name','Small_Wheel','wheels/Large_Wheel')
```

## See Also

find\_system, set\_param

**Purpose**

Save Simulink system

**Syntax**

```
save_system
save_system('sys')
save_system('sys', 'newname')
save_system('sys', 'newname', 'BreakAllLinks', true)
save_system('sys', 'newname', 'BreakUserLinks', true)
save_system('sys', 'newname', 'SaveModelWorkspace', true)
save_system('sys', 'newname', 'ErrorIfShadowed', true)
save_system('sys', 'newname', 'SaveAsVersion', 'version')
save_system('sys', 'newname', 'OverWriteIfChangedOnDisk', true)
save_system('sys', 'newname', 'SaveModelWorkspace', true,
    'BreakLinks', true, 'OverwriteIfChangedOnDisk', true)
```

**Description**

`save_system` saves the current top-level system to a file with its current name.

`save_system('sys')` saves the specified top-level system to a file with its current name. The system must be open. 'sys' can be a string, a cell array of strings, a numeric handle, or an array of numeric handles.

`save_system('sys', 'newname')` saves the specified top-level system to a file with the specified new name. The system to be saved must be open. The new name can be a file name, in which case Simulink saves the system in the working directory, or a fully qualified pathname. On UNIX, the fully qualified pathname can start with a tilde (~), signifying your home directory.

'newname' can be empty ([]), in which case the current name is used. If 'sys' refers to more than one block diagram, 'newname' must be a cell array of new names.

This command displays an error if you enter any of the following as the new model name:

- A MATLAB keyword
- 'simulink'

- More than 63 characters

Additional arguments must be supplied as name-value pairs, in any order. Allowed names are:

- `ErrorIfShadowed`: true or false (default: false)

Generates an error if the specified new name already exists on the MATLAB path or workspace.

- `BreakAllLinks`: true or false (default: false)

Replaces links to library blocks with copies of the library blocks in the saved file. The 'BreakLinks' option affects any linked block, including user-defined and Simulink library blocks.

---

### Note

The 'BreakAllLinks' option can result in compatibility issues when upgrading to newer versions of Simulink. For example:

- Any masks on top of library links to Simulink S-functions will not upgrade to the new version of the S-function.
- Any library links to masked subsystems in a Simulink library will not upgrade to the new subsystem behavior.
- Any broken links prevent the automatic library forwarding mechanism from upgrading the link.

If you have saved a model with broken links, use the `Check model, local libraries, and referenced models for known upgrade issues` option in the Model Advisor to scan the model for out-of-date blocks. You can then use the `slupdate` command to upgrade the Simulink blocks to their current versions. Subsequently running the Model Advisor lists any remaining third-party library and optional Simulink blockset blocks that are still out of date and need to be manually upgraded.

---



- **BreakUserLinks:** true or false (default: false)  
Replaces links to user-defined library blocks with copies of the library blocks in the saved file.
- **SaveAsVersion:** MATLAB version name (default: current)  
Saves the system in a form that can be loaded by a specified version of Simulink. Valid values include R12, R12P1, R13, R13SP1, R14, R14SP1, R14SP2, R14SP3, R2006A, R2006B, R2007A. These are case insensitive. If the system to be saved contains blocks not supported by the specified Simulink version, the command replaces the unsupported blocks with empty masked subsystem blocks colored yellow. As a result, the converted system may generate incorrect results.
- **OverwriteIfChangedOnDisk:** true or false (default: false)  
If the file has changed on disk since the model was loaded, `save_system` displays an error to prevent the changes on disk from being overwritten. This error appears only if the **Saving the model** option in the **Model File Change Notification** section of the Simulink Preferences dialog is selected.  
  
To save the model regardless of whether the file has been changed on disk supply the `OverwriteIfChangedOnDisk` option with value `true`.
- **SaveModelWorkspace:** true or false (default: false)  
If the model workspace `DataSource` is a MAT-file, this command also saves the contents of the model workspace. 'SaveModelWorkspace' is most useful when `DataSource` is a MAT-file.

The same options are applied to all the block diagrams that are saved.

`save_system` returns the full name of the file that was saved, as a string. If multiple files were saved, the return value is a cell array of strings.

`save_system` can save only entire block diagrams, but the utility function `Simulink.SubSystem.copyContentsToBlockDiagram` can be used to copy the contents of a subsystem into a new block diagram, which can then be saved using `save_system`.

## Examples

This command saves the current system.

```
save_system
```

This command saves the vdp system with the name vdp.

```
save_system('vdp')
```

This command saves the vdp system to a file with the name 'myvdp'.

```
save_system('vdp', 'myvdp')
```

This command saves the vdp system to another directory.

```
save_system('vdp', 'C:\TMP\vdp.mdl')
```

This command saves the vdp system to a file with the name 'myvdp' and replaces links to library blocks with copies of the library blocks in the saved file.

```
save_system('vdp', 'myvdp', 'BreakLinks', true)
```

Both of these commands save the current model (with its current name), and break any library links in it:

```
save_system('mymodel', 'mymodel', 'BreakLinks', true)  
save_system('mymodel', [], 'BreakLinks', true)
```

This command saves the current model with a new name, but displays an error (instead of saving) if something with this name already exists on the MATLAB path:

```
save_system('mymodel', 'mynewmodel', 'ErrorIfShadowed', true)
```

This command tries to save the vdp system to a file with the name 'max', but returns an error because 'max' is the name of a MATLAB function.

```
save_system('vdp', 'max', 'ErrorIfShadowed', true)
```

This command saves the vdp system to Simulink Version R13SP1 with the name 'myvdp'. It does not replace links to library blocks with copies of the library blocks.

```
save_system('vdp','myvdp','SaveAsVersion','R13SP1')
```

This command saves the current model with a new name, saves the model workspace, breaks any library links, and overwrites if the file has changed on disk:

```
save_system('mymodel','mynewmodel','SaveModelWorkspace',  
true,'BreakLinks',true,'OverwriteIfChangedOnDisk',true)
```

This command returns the full path name of the file that was saved, as a string. If multiple files were saved, the return value is a cell array of strings.

```
filename = save_system('mymodel')
```

### See Also

`close_system`, `new_system`, `open_system`

# set\_param

---

## Purpose

Set Simulink system and block parameters

## Syntax

```
set_param('obj', 'parameter1', value1, 'parameter2', value2, ...)  
set_param(0, 'modelparm1', value1, 'modelparm2', value2, ...)
```

## Description

`set_param('obj', 'parameter1', value1, 'parameter2', value2, ...)`, where 'obj' is a system or block path, sets the specified parameters to the specified values. Value strings are case sensitive. Case is ignored for parameter names. Any parameters that correspond to dialog box entries have string values. Model and block parameters are listed in Chapter 8, “Model and Block Parameters”.

`set_param(0, 'modelparm1', value1, 'modelparm2', value2, ...)` sets the specified model parameters to default values, i.e., to values that Simulink assigns to the parameters when it creates a model. You can use this form of `set_param` in your MATLAB startup file to specify your own default values for Simulink model parameters.

You can change block parameter values in the workspace during a simulation and update the block diagram with these changes. To do this, make the changes in the command window, then make the model window the active window, then choose **Update Diagram** from the **Edit** menu.

---

**Note** Most block parameter values must be specified as strings. Two exceptions are the `Position` and `UserData` parameters, common to all blocks.

---

## Examples

This command sets the `Solver` and `StopTime` parameters of the `vdp` system.

```
set_param('vdp', 'Solver', 'ode15s', 'StopTime', '3000')
```

This command sets the Gain parameter of block Mu in the vdp system to 1000.

```
set_param('vdp/Mu', 'Gain', '1000')
```

This command sets the position of the Fcn block in the vdp system.

```
set_param('vdp/Fcn', 'Position', [50 100 110 120])
```

This command sets the Zeros and Poles parameters for the Zero-Pole block in the mymodel system.

```
set_param('mymodel/Zero-Pole', 'Zeros', '[2 4]', 'Poles', '[1 2 3]')
```

This command sets the Gain parameter for a block in a masked subsystem. The variable k is associated with the Gain parameter.

```
set_param('mymodel/Subsystem', 'k', '10')
```

This command sets the OpenFcn callback parameter of the block named Compute in system mymodel. The function 'my\_open\_fcn' executes when you double-click on the Compute block (see “Using Callback Functions”).

```
set_param('mymodel/Compute', 'OpenFcn', 'my_open_fcn')
```

### See Also

find\_system, get\_param

# setActiveConfigSet

---

<b>Purpose</b>	Specifies model's active configuration set or configuration reference
<b>Syntax</b>	<code>setActiveConfigSet('model', 'configObjName')</code>
<b>Arguments</b>	<i>model</i> The name of an open model, or gcs to specify the current model <i>configObjName</i> The name of a configuration set (Simulink.ConfigSet) or configuration reference (Simulink.ConfigSetRef)
<b>Description</b>	<code>setActiveConfigSet</code> specifies the active configuration set or configuration reference (configuration object) of <i>model</i> to be the configuration object specified by <i>configObjName</i> . If no such configuration object is attached to the model, an error occurs. The previously active configuration object becomes inactive.
<b>Example</b>	The following example makes DevConfig the active configuration object of the current model. The code is the same whether DevConfig is a configuration set or configuration reference. <pre>setActiveConfigSet(gcs, 'DevConfig');</pre>
<b>See Also</b>	“Configuration Sets”, “Referencing Configuration Sets” <code>attachConfigSet</code> , <code>attachConfigSetCopy</code> , <code>closeDialog</code> , <code>detachConfigSet</code> , <code>getActiveConfigSet</code> , <code>getConfigSet</code> , <code>getConfigSets</code> , <code>openDialog</code>

**Purpose** Create MATLAB structure describing signed generalized fixed-point data type

**Syntax** `a = sfix(TotalBits)`

**Description** `sfix(TotalBits)` returns a MATLAB structure that describes the data type of a signed generalized fixed-point number with a word size given by `TotalBits`.

`sfix` is automatically called when a signed generalized fixed-point data type is specified in a block dialog box.

---

**Note** A default binary point is not included in this data type description. Instead, the scaling must be explicitly defined in the block dialog box.

---

**Examples** Define a 16-bit signed generalized fixed-point data type:

```
a = sfix(16)
a =
    Class: 'FIX'
   IsSigned: 1
  MantBits: 16
```

**See Also** `fixdt`, `float`, `sfrac`, `sint`, `ufix`, `ufrac`, `uint`

# sfrac

---

**Purpose** Create MATLAB structure describing signed fractional data type

**Syntax**

```
a = sfrac(TotalBits)
a = sfrac(TotalBits, GuardBits)
```

**Description** `sfrac(TotalBits)` returns a MATLAB structure that describes the data type of a signed fractional number with a word size given by `TotalBits`.

`sfrac(TotalBits, GuardBits)` returns a MATLAB structure that describes the data type of a signed fractional number. The total word size is given by `TotalBits` with `GuardBits` bits located to the left of the sign bit.

`sfrac` is automatically called when a signed fractional data type is specified in a block dialog box.

The default binary point for this data type is assumed to lie immediately to the right of the sign bit. If guard bits are specified, they lie to the left of the binary point in addition to the sign bit.

**Examples** Define an 8-bit signed fractional data type with 4 guard bits. Note that the range of this number is  $-2^4 = -16$  to  $(1 - 2^{(1-8)}) \cdot 2^4 = 15.875$ :

```
a = sfrac(8,4)
a =
    Class: 'FRAC'
   IsSigned: 1
  MantBits: 8
 GuardBits: 4
```

**See Also** `fixdt`, `float`, `sfix`, `sint`, `ufix`, `ufrac`, `uint`



**Purpose** Create and access Signal Builder blocks

**Syntax**

```
[time, data] = signalbuilder(block)
[time, data, siglabels] = signalbuilder(block)
[time, data, siglabels, grouplabels] = signalbuilder(block)
block = signalbuilder([], 'create', time, data, siglabels,
    grouplabels)
block = signalbuilder(block, 'append', time, data, siglabels,
    grouplabels)

[time, data] = signalbuilder(block, 'get', signal, group)
signalbuilder(block, 'set', signal, group, time, data)

index = signalbuilder(block, 'activegroup')
signalbuilder(block, 'activegroup', index)

signalbuilder(block, 'print', [])
signalbuilder(block, 'print', config, printArgs)
figh = signalbuilder(block, 'print', config, 'figure')
```

**Description** Use the signalbuilder command to interact programmatically with Signal Builder blocks.

- “Create and Access Signal Builder Blocks” on page 4-129
- “Get/Set Methods for Specific Signals and Groups” on page 4-130
- “Query and Set the Active Group” on page 4-131
- “Print Signal Groups” on page 4-131

### Create and Access Signal Builder Blocks

[time, data] = signalbuilder(*block*) returns the time (x-coordinate) and amplitude (y-coordinate) data of the Signal Builder block, *block*.

The output arguments, time and data, take different formats depending on the block configuration:

Configuration	Time/Data Format
1 signal, 1 group	Row vector of break points.
>1 signal, 1 group	Column cell vector where each element corresponds to a separate signal and contains a row vector of breakpoints.
1 signal, >1 group	Row cell vector where each element corresponds to a separate group and contains a row vector of breakpoints.
>1 signal, >1 group	Cell matrix where each element (i, j) corresponds to signal i and group j.

`[time, data, siglabels] = signalbuilder(block)` returns the signal labels, `siglabels`, in a string or a cell array of strings.

`[time, data, siglabels, grouplabels] = signalbuilder(block)` returns the group labels, `grouplabels`, in a string or a cell array of strings.

`block = signalbuilder([], 'create', time, data, siglabels, grouplabels)` creates a Signal Builder block in a new Simulink model using the specified values. If `data` is a cell array and `time` is a vector, the `time` values are duplicated for each element of `data`. Each vector in `time` and `data` must be the same length and have at least two elements. If `time` is a cell array, all elements in a column must have the same initial and final value. Signal labels, `siglabels`, and group labels, `grouplabels`, can be omitted to use default values. The function returns the path to the new block, `block`.

`block = signalbuilder(block, 'append', time, data, siglabels, grouplabels)` appends new groups to the Signal Builder block, `block`. The `time` and `data` arguments must have the same number of signals as the existing block.

## Get/Set Methods for Specific Signals and Groups

`[time, data] = signalbuilder(block, 'get', signal, group)` gets the time and data values for the specified signal(s) and group(s).

The signal argument can be the name of a signal, a scalar index of a signal, or an array of signal indices. The group argument can be a group label, a scalar index, or an array of indices.

`signalbuilder(block, 'set', signal, group, time, data)` sets the time and data values for the specified signal(s) and group(s). Use empty values of *time* and *data* to remove groups and signals.

## Query and Set the Active Group

`index = signalbuilder(block, 'activegroup')` gets the index of the active group.

`signalbuilder(block, 'activegroup', index)` sets the active group index to *index*.

## Print Signal Groups

`signalbuilder(block, 'print', [])` prints the currently active signal group.

`signalbuilder(block, 'print', config, printArgs)` prints the currently active signal group or the signal group that *config* specifies. The argument *config* is a structure that allows you to customize the printed appearance of a signal group by specifying values for any of the following fields:

- `groupIndex` — signal group index
- `timeRange` — time range (limited to full group range)
- `visibleSignals` — index of signals to display
- `yLimits` — cell array of Y-Limits for each signal
- `extent` — pixel extent of captured figure
- `showTitle` — true (default) indicates a title should be displayed

The optional argument *printArgs* allows you to configure print options (see `print` in the MATLAB Function Reference).

# signalbuilder

---

`figh = signalbuilder(block, 'print', config, 'figure')` prints the currently active signal group or the signal group that *config* specifies to a new hidden figure handle, `figh`.

---

<b>Purpose</b>	Simulate dynamic system
<b>Syntax</b>	<pre>[t,x,y] = sim(model,timespan,options,ut); [t,x,y1, y2, ..., yn] = sim(model,timespan,options,ut);</pre>
<b>Description</b>	<p>The <code>sim</code> command executes a Simulink model, using all <b>Configuration Parameters</b> dialog box settings, including the options specified on the <b>Data Import/Export</b> pane.</p> <p>You can supply a null (<code>[]</code>) matrix for any right-side argument except the first (the model name). The <code>sim</code> command uses default values for unspecified arguments and arguments specified as null matrices. The default values are the values specified by the model. You can set optional simulation parameters, using the <code>sim</code> command's options argument. Parameters set in this way override parameters specified by the model.</p> <p>If you do not specify the left side arguments, the command logs the simulation data specified by the <b>Data Import/Export</b> pane of the <b>Configuration Parameters</b> dialog box (see “Data Import/Export Pane”).</p> <p>If you want to simulate a continuous system, you must specify the solver parameter, using <code>simset</code>. The solver defaults to <code>VariableStepDiscrete</code> for purely discrete models.</p>

---

**Note** The base workspace for a simulation launched by the `sim` command is the MATLAB workspace by default, with one exception. The exception is that the default workspace for To Workspace blocks is the current workspace, i.e., the workspace of the function that invoked the `sim` command. You can use the `DstWorkspace` and `SrcWorkspace` options of the `sim` command (see `simset`) to change these defaults. For example, suppose that you want to use the workspace of the function that invokes the `sim` command as the base workspace of the simulation. To do this, specify `current` as the value of the `DstWorkspace` and `SrcWorkspace` options.

---

## Arguments

<code>t</code>	Returns the simulation's time vector.
<code>x</code>	Returns the simulation's state matrix consisting of continuous states followed by discrete states.
<code>y</code>	Returns the simulation's output matrix. Each column contains the output of a root-level Output block, in port number order. If any Output block has a vector input, its output takes the appropriate number of columns.
<code>y1, ..., yn</code>	Each $y_i$ returns the output of the corresponding root-level Output block for a model that has $n$ such blocks.
<code>model</code>	Name of a block diagram.

timespan	<p>Simulation start and stop time. Specify as one of these:</p> <p>tFinal to specify the stop time. The start time is 0.</p> <p>[tStart tFinal] to specify the start and stop times.</p> <p>[tStart OutputTimes tFinal] to specify the start and stop times and time points to be returned in t. Generally, t will include more time points. OutputTimes is equivalent to choosing <b>Produce additional output</b> on the dialog box.</p>
options	<p>Optional simulation parameters specified as a structure created by the simset command (see simset).</p>
ut	<p>Optional external inputs to top-level Inport blocks. ut can be a MATLAB function (expressed as a string) that specifies the input <math>u = UT(t)</math> at each simulation time step, a table of input values versus time for all input ports, or a comma-separated list of tables, ut1, ut2, ..., each of which corresponds to a specific port. Tabular input for all ports can be in the form of a MATLAB array or a structure. Tabular input for individual ports must be in the form of a structure. See “Importing Data from the MATLAB Workspace” in the online documentation for a description of the array and structure input formats.</p>

## Examples

This command simulates the Van der Pol equations, using the vdp model that comes with Simulink. The command uses all default parameters.

```
[t,x,y] = sim('vdp')
```

This command simulates the Van der Pol equations, using the parameter values associated with the vdp model, but defines a value for the Refine parameter.

```
[t,x,y] = sim('vdp', [], simset('Refine',2));
```

This command simulates the Van der Pol equations for 1,000 seconds, saving the last 100 rows of the return variables. The simulation outputs values for t and y only, but saves the final state vector in a variable called xFinal.

```
[t,x,y] = sim('vdp', 1000, simset('MaxRows', 100,  
    'OutputVariables', 'ty', 'FinalStateName', 'xFinal'));
```

## See Also

simset, simget



**Purpose**

Get settings of model's simulation parameters

**Syntax**

```
struct = simget(model)  
value = simget(model, 'param')  
value = simget(OptionStructure, param)  
simget
```

**Description**

*struct* = simget(*model*) returns the current simulation parameter settings for the specified model as a structure compatible with the options argument of the sim command. You can use this command along with the simset command to override model-specified simulation options for a particular simulation run. See simset for more information. If the model uses a workspace variable to specify a simulation parameter, simget returns the variable's value, not its name. If the variable does not exist in the workspace, Simulink issues an error message.

*value* = simget(*model*, '*param*') returns the value of the simulation parameter, '*param*', specified by the model, *model*.

*value* = simget(*OptionStructure*, *param*) extracts the value of the specified simulation parameter from *OptionStructure*, returning an empty matrix if the value is not specified in the structure. *param* can be a cell array containing a list of parameter names. If a cell array is used, the output is also a cell array.

simget returns a structure containing the names of simulation parameters recognized by the simget command.

You need to enter only as many leading characters of a property name as are necessary to identify it.

**Examples**

This command retrieves the simulation options for the vdp model.

```
options = simget('vdp');
```

# simget

---

This command retrieves the value of the `Refine` property for the `vdp` model.

```
refine = simget('vdp', 'Refine');
```

## See Also

`sim`, `simset`

**Purpose** Plot simulation data in figure window

**Syntax**

```
simplot(data);  
simplot(time, data);  
simplot(data, ports);  
simplot(data, 'diff')  
simplot(time, data, ports, 'diff')
```

**Description** The `simplot` command plots output from a simulation in a Handle Graphics® figure window. The plot looks like the display on the screen of a Scope block. Plotting the output on a figure window allows you to annotate and print the output.

The data to be plotted can be either a data structure or a matrix of the form produced by Simulink output blocks.

### **Specifying a Separate Time Vector**

If data is a matrix or a structure without time, you can specify a separate time vector. `time` must be a vector with the same length as `data`.

For example:

```
simplot(time,data)
```

### **Specifying Specific Ports to Display**

If data is a structure produced by a multi-port Scope block, the data from each port is displayed in a separate subplot. You can select specific ports to display by supplying a vector of port indices.

For example:

```
ports = [1,3];  
simplot(data,ports)
```

plots the data from the first and third ports.

## Overlaying Plots from Multiple Runs

If data is a cell array of structures or matrices, Simulink overlays the plots from each element so that you can compare multiple runs. Each run is assumed to have identical structure. Line styles are used to differentiate between runs.

For example:

```
data = {run1, run2};  
simplot(data)
```

overlays the data from run1 and run2.

---

**Note** If data contains Matrices or Structures without time, the data sets for all runs must be the same size.

---

You can use the 'diff' flag to display the differences between multiple runs. When you specify the 'diff' flag, Simulink subtracts the first run from subsequent runs, and plots the results with the line style of the final run being compared.

For example:

```
data = {run1,run2};  
simplot(data, 'diff')
```

plots run2 — run 1 using the line style of run2.

---

**Note** Simulink uses linear interpolation if the time vectors are not identical.

If the start and stop times differ between runs, the difference is only plotted for the region of overlap.

---

### Combining Input Argument Options:

The options described above can be used in various combinations. All input arguments except for data are optional but when included must be entered in the following order:

```
simplot(time, data, ports, 'diff')
```

### Obtaining Object Handles

You can obtain the handles for the plotted figure, its axes and lines using the `simplot` command:

- `hfig = simplot(data)` — returns the figure handles.
- `haxes = simplot(data)` — returns the handles for the figure axes.
- `hlins = simplot(data)` — returns the handles for the lines in the figure.

## Arguments

data	Data produced by one of the Simulink output blocks (for example, a root-level Output block or a To Workspace block) or in one of the output formats used by those blocks: <b>Array</b> , <b>Structure</b> , <b>Structure with time</b> (see “Data Import/Export Pane”).
time	The vector of sample times produced by an output block when you have selected <b>Array</b> or <b>Structure</b> as the simulation’s output format.  The <code>simplot</code> command ignores this argument if the format of the data is Structure with time.

# simplot

---

ports	The vector of port indices from which to display data. If the data is a structure produced by a multi-port Scope block, the data from each port is displayed in a separate subplot.
'diff'	Displays the differences between multiple runs. When you specify the 'diff' flag, Simulink subtracts the first run from subsequent runs, and plots the results with the line style of the final run being compared.

## Examples

The following sequence of commands

```
vdp
set_param(gcs, 'SaveOutput', 'on')
set_param(gcs, 'SaveFormat', 'StructureWithTime')
sim(gcs)
simplot(yout)
```

plots the output of the vdp demo model on a figure window as follows.

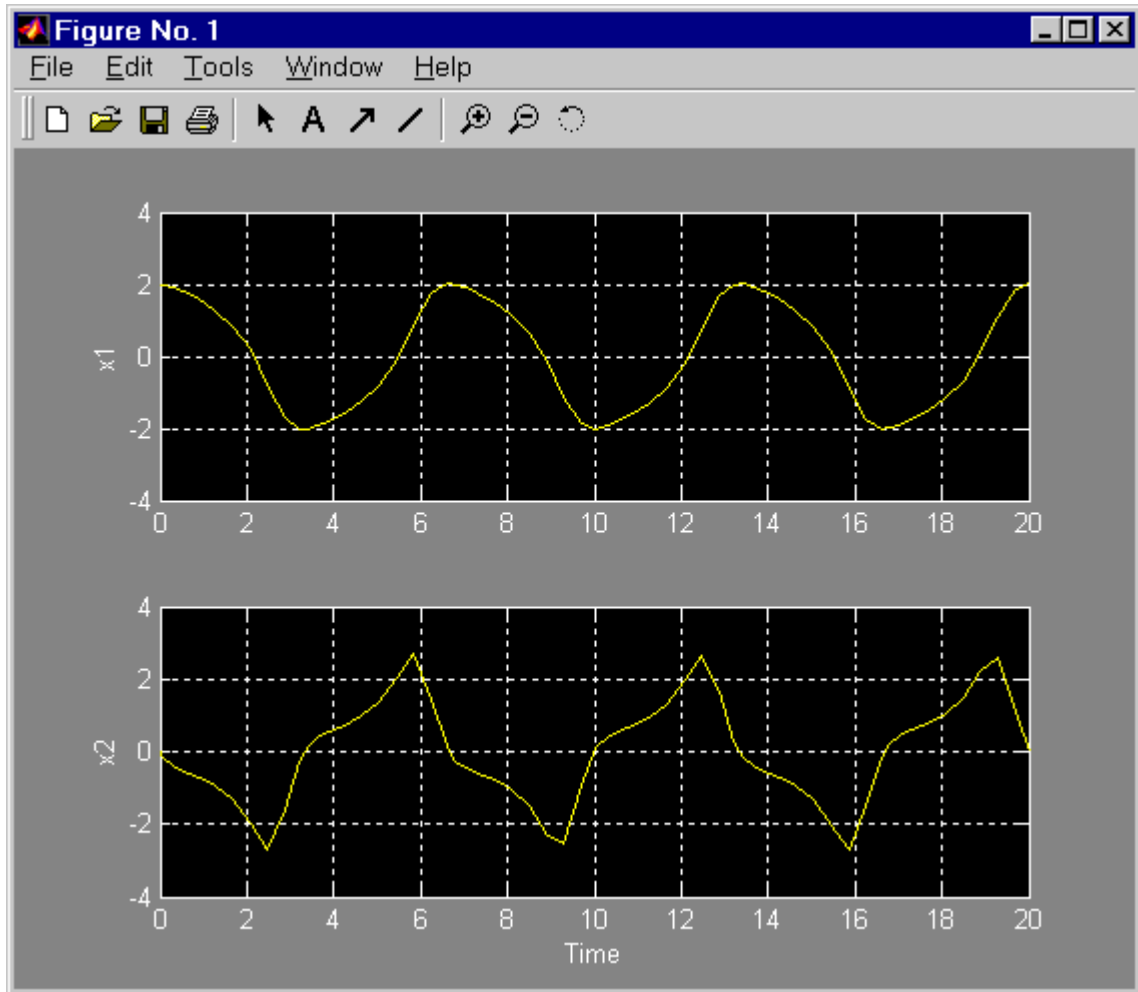

**See Also** `sim`, `set_param`, `plot`

# simset

---

**Purpose** Specify simulation options for simulations run via `sim` command

**Syntax**

```
options = simset(param, value, ...);  
options = simset(old_opstruct, param, value, ...);  
options = simset(old_opstruct, new_opstruct);  
simset
```

**Description** The `simset` command creates and returns the structure required by the `options` argument of the `sim` command. The structure specifies the simulation parameter values to be used for the simulation run initiated by the `sim` command to which the structure is passed.

---

**Note** The parameter values specified by the structure apply only to the simulation run initiated by the `sim` command to which the structure is passed. They override the permanent values of the simulation parameters for that simulation run. If you want to set the permanent value of a simulation parameter, use the Model Editor's **Configuration Parameters** dialog box or the `set_param` command.

---

You can enter the values of the parameters as paired arguments of the `simset` command, e.g., 'Debug', 'on'. You need enter only as many leading characters as are necessary to identify a parameter. The structure contains default values for parameters that you do not specify.

`options = simset(param, value, ...)` returns an options structure containing the specified values for the specified parameters and default values for unspecified parameters.

`options = simset(old_opstruct, param, value, ...)` modifies the specified parameters in `old_opstruct`, an existing structure. You can use this form of the command to override the values of simulation parameters specified by the model to be simulated. To do this, use the `simget` command to get the settings specified by the model and pass the settings to `simset` along with the parameters that you want to override.



`options = simset(old_opstruct, new_opstruct)` combines two existing options structures, `old_opstruct` and `new_opstruct`, into `options`. Any properties defined in `new_opstruct` overwrite the same properties defined in `old_opstruct`.

`simset` with no input arguments displays all parameter names and values that the `simset` command can specify

If a parameter is set twice within one call to the `simset` command, the last value in the list is used. For example:

```
simset('MaxStep', 0.01, 'MaxStep', 0.02)
```

assigns the final value of 0.02 to the `MaxStep` property.

## Parameters

**AbsTol** positive scalar {1e-6}  
*Absolute error tolerance.* This scalar applies to all elements of the state vector. `AbsTol` applies only to the variable-step solvers.

**Debug** 'on' | {'off'} | cmds  
*Debug.* Starts the simulation in debug mode (see “Starting the Debugger” in *Using Simulink* for more information). The value of this option can be a cell array of commands to be sent to the debugger after it starts, e.g.,

```
opts = simset('debug', ...
    {'strace 4', ...
    'diary solvertrace.txt', ...
    'cont', ...
    'diary off', ...
    'cont'})
sim('vdp', [], opts);
```

**Decimation** positive integer {1}  
*Decimation for output variables.* Decimation factor applied to the return variables `t`, `x`, and `y`. A decimation factor of 1 returns every data logging time point, a decimation factor of 2 returns every other data logging time point, etc.

- DstWorkspace**            base | {current} | parent  
*Where to assign variables.* Specifies the workspace in which to assign any variables defined as return variables or as output variables on the To Workspace block.
- ExtrapolationOrder**        1 | 2 | 3 | {4}  
*ode14x extrapolation order.* Specifies extrapolation order of the ode14x implicit fixed-step solver.
- FinalStateName**          string {''}  
*Name of final states variable.* This property specifies the name of a variable in which Simulink saves the model's states at the end of the simulation.
- FixedStep**                positive scalar  
*Fixed step size.* This property applies only to the fixed-step solvers. If the model contains discrete components, the default is the fundamental sample time; otherwise, the default is one-fiftieth of the simulation interval.
- InitialState**            vector {[]}  
*Initial continuous and discrete states.* The initial state vector consists of the continuous states (if any) followed by the discrete states (if any). InitialState supersedes the initial states specified in the model. The default, an empty matrix, causes the initial state values specified in the model to be used. The initial state values can be specified using either an array, structure, or structure-with-time format. See Importing and Exporting States for more information.
- InitialStep**             positive scalar {auto}  
*Suggested initial step size.* This property applies only to the variable-step solvers. The solvers try a step size of InitialStep first. By default, the solvers determine an initial step size automatically.
- MaxOrder**                1 | 2 | 3 | 4 | {5}  
*Maximum order of ode15s.* This property applies only to ode15s.

- MaxDataPoints**            nonnegative integer {0}  
*Limit number of output data points.* This property limits the number of data points returned in `t`, `x`, and `y` to the last `MaxDataPoints` data logging time points. If specified as 0, the default, no limit is imposed.
- MaxStep**                    positive scalar {auto}  
*Upper bound on the step size.* This property applies only to the variable-step solvers and defaults to one-fiftieth of the simulation interval.
- MinStep**                    [positive scalar, nonnegative integer] {auto}  
*Lower bound on the step size.* This property applies only to the variable-step solvers and defaults to one-fiftieth of the simulation interval.
- NumberNewtonIterations**    positive integer {1}  
*Number of Newton iterations.* Specifies number of Newton's Method iterations to be performed by the `ode14x` implicit fixed-step solver.
- OutputPoints**                {specified} | all  
*Determine output points.* When set to `specified`, the solver produces outputs `t`, `x`, and `y` only at the times specified in `timespan`. When set to `all`, `t`, `x`, and `y` also include the time steps taken by the solver.
- OutputVariables**            {txy} | tx | ty | xy | t | x | y  
*Set output variables.* If `'t'`, `'x'`, or `'y'` is missing from the property string, the solver produces an empty matrix in the corresponding output `t`, `x`, or `y`.
- Refine**                      positive integer {1}  
*Output refine factor.* This property increases the number of output points by the specified factor, producing smoother output. `Refine` applies only to the variable-step solvers. It is ignored if output times are specified.

**RelTol**                    positive scalar {1e-3}  
*Relative error tolerance.* This property applies to all elements of the state vector. The estimated error in each integration step satisfies

$$e(i) \leq \max(\text{RelTol} * \text{abs}(x(i)), \text{AbsTol}(i))$$

This property applies only to the variable-step solvers and defaults to 1e-3, which corresponds to accuracy within 0.1%.

**Solver**                    VariableStepDiscrete |  
    ode45 | ode23 | ode113 | ode15s | ode23s |  
    FixedStepDiscrete |  
    ode5 | ode4 | ode3 | ode2 | ode1

*Method to advance time.* This property specifies the solver that is used to advance time.

**SaveFormat**                {'Array'} | 'Structure' | 'StructureWithTime'  
*How to save output to workspace.* Specifies format for exporting model states and root-level outputs to the MATLAB workspace. See “Exporting Data to the MATLAB Workspace” for more information.

**SrcWorkspace**              {base} | current | parent  
*Where to evaluate expressions.* This property specifies the workspace in which to evaluate MATLAB expressions defined in the model.

**Trace**                      'minstep', 'siminfo', 'compile' {''}  
*Tracing facilities.* This property enables simulation tracing facilities (specify one or more as a comma-separated list):

- The 'minstep' trace flag specifies that simulation stops when the solution changes so abruptly that the variable-step solvers cannot take a step and satisfy the error tolerances. By default, Simulink issues a warning message and continues the simulation.
- The 'siminfo' trace flag provides a short summary of the simulation parameters in effect at the start of simulation.

- The 'compile' trace flag displays the compilation phases of a block diagram model.

`ZeroCross`                    {on} | off  
*Enable/disable location of zero crossings.* This property applies only to the variable-step solvers. If set to off, variable-step solvers do not detect zero crossings for blocks having intrinsic zero-crossing detection. The solvers adjust their step sizes only to satisfy error tolerance.

`SignalLogging`                {on} | off  
*Enable/disable signal logging.* This parameter enables signal logging for the model, overriding the **Signal logging** setting in the **Configuration Parameters** dialog box.

`SignalLoggingName`            string  
*Specify signal logging name.* This parameter specifies the name of the signal logging object used to record logged signal data in the MATLAB workspace. It overrides the **Signal logging** name setting in the **Configuration Parameters** dialog box.

## Examples

This command creates an options structure called `myopts` that defines values for the `MaxDataPoints` and `Refine` parameters, using default values for other parameters.

```
myopts = simset('MaxDataPoints', 100, 'Refine', 2);
```

This command simulates the `vdp` model for 10 seconds and uses the parameters defined in `myopts`.

```
[t,x,y] = sim('vdp', 10, myopts);
```

The following command overrides the signal logging setting specified by the `vdp` model.

```
sim('vdp', 10, simset(simget('vdp'), 'SignalLogging', 'on'))
```

## See Also

`sim`, `simget`

# simulink

---

**Purpose** Open Simulink block library

**Syntax**  
`simulink`  
`simulink('open')`  
`simulink('close')`

**Description** On Microsoft Windows, `simulink` or `simulink('open')` opens the Simulink block library browser. On UNIX, the command opens the Simulink library window. `simulink('close')` closes the library window.

# Simulink.BlockDiagram.addBusToVector

---

## Purpose

Add Bus to Vector blocks to convert bus signals used as muxes/vectors to vectors

## Syntax

```
[DstBlocks, BusToVectorBlocks] =  
Simulink.BlockDiagram.addBusToVector(model)  
[DstBlocks, BusToVectorBlocks] =  
Simulink.BlockDiagram.addBusToVector(model, includeLibs)  
[DstBlocks, BusToVectorBlocks] =  
Simulink.BlockDiagram.addBusToVector(model,  
includeLibs, reportOnly)
```

## Arguments

*model*

Model name or handle

*includeLibs*

Boolean specifying whether to search library blocks. Default: false; the function does not search library blocks.

*reportOnly*

Boolean specifying whether to change the model or just generate a report. Default: true; the function just generates a report.

## Returns

*DstBlocks*

An array of structures that contain information about blocks that are connected to buses but treat the buses as vectors. If no such blocks exist the array has 0 length. Each structure in the array contains the following fields:

BlockPath

A string specifying the path to the block to which the bus connects

InputPort

An integer specifying the input port to which the bus connects

# Simulink.BlockDiagram.addBusToVector

---

## LibPath

If the block is a library block instance, and *includeLibs* is true, the path to the source library block. Otherwise, LibPath is empty ( []).

## BusToVectorBlocks

If *reportOnly* is false, and *model* contains any buses used as vectors, a cell array containing the path to each Bus to Vector block that was added to the model. Otherwise, *BusToVectorBlocks* is empty ( []).

## Description

Simulink.BlockDiagram.addBusToVector reports whether a model contains any bus signals used implicitly as vectors, and optionally changes the model by inserting a Bus to Vector block into each such signal, replacing the implicit use with an explicit conversion. The report and any changes can be limited to the model itself, or can be extended to include any library block of which an instance appears in the model.

Before executing this function, you must do the following:

- 1 Set Configuration Parameters > Diagnostics > Connectivity > Buses > Mux blocks used to create bus signals** to error, or equivalently, execute `set_param(model, 'StrictBusMsg', 'ErrorLevel1')`.
- 2 Ensure that the model compiles without error.**
- 3 Save the model.**

If *includeLibs* is false (the default), the function does not report on or change any blocks in libraries. If the argument is true, the function reports on and may change blocks in libraries.

If *reportOnly* is true (the default), the function does not change the model or any libraries, displays the number of buses used as vectors, and returns a report in *DstBlocks*.

If *reportOnly* is false, the function displays the number of buses used as vectors, returns a report in *DstBlocks* and *BusToVectorBlocks*,



and inserts a Bus to Vector block into each bus that is used as a vector, in the model and optionally in any libraries. The signal's source and destination blocks are unchanged by this insertion.

---

**Note** If `Simulink.BlockDiagram.addBusToVector` adds Bus to Vector blocks to the model or any library, the function permanently changes the saved copy of the diagram. Be sure to back up the model and any libraries before calling the function with *reportOnly* specified as `false`.

---

---

### Caution

If `Simulink.BlockDiagram.addBusToVector` changes a library block, the change affects every instance of that block in every Simulink model that uses the library. To preview the effects of the change on blocks in all models, call `Simulink.BlockDiagram.addBusToVector` with *includeLibs* = `true` and *reportOnly* = `true`, then examine the information returned in *DstBlocks*.

---

The Bus to Vector block is intended only for use in existing models to facilitate the elimination of implicit conversion of buses into muxes/vectors. New models and new parts of existing models should avoid mixing composite signals, and should not use Bus to Vector blocks for any purpose. See “Intermixing Composite Signal Types” for more information about using `Simulink.BlockDiagram.addBusToVector`.

### Example

The following model simulates correctly, but the input to the Gain block is a bus, while the output is a vector. Thus the Gain block uses a block as a vector.

# Simulink.BlockDiagram.addBusToVector

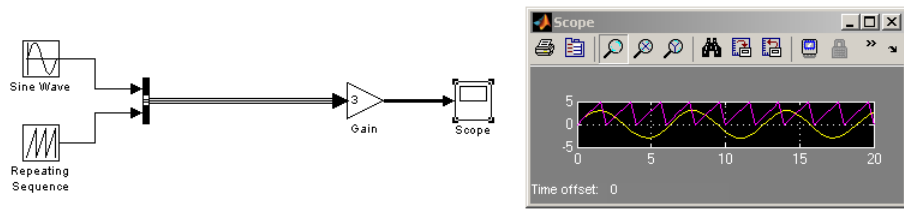

If the model shown is open as the current model, you can eliminate the implicit conversion with the following command:

```
Simulink.BlockDiagram.addBusToVector(gcs, false, false)
```

Rebuilding and simulating the model then gives this result:

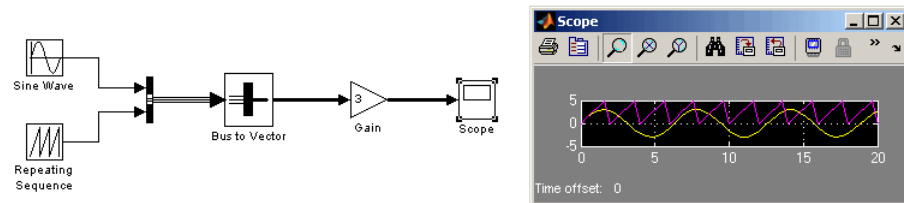

The Gain block no longer implicitly converts a bus to a vector; the inserted Bus to Vector block performs the conversion explicitly. Note that the results of simulation are the same for both models. The Bus to Vector block is virtual, and never affects simulation results, code generation, or performance.

## See Also

Bus to Vector

“Intermixing Composite Signal Types”

# Simulink.BlockDiagram.copyContentsToSubSystem

---

<b>Purpose</b>	Copy contents of block diagram to empty subsystem
<b>Syntax</b>	<code>Simulink.BlockDiagram.copyContentsToSubSystem(<i>bdiag</i>, <i>subsys</i>)</code>
<b>Arguments</b>	<i>bdiag</i> Block diagram name or handle <i>subsys</i> Subsystem name or handle
<b>Description</b>	<code>Simulink.BlockDiagram.copyContentsToSubSystem</code> copies the contents of the block diagram <i>bdiag</i> to the subsystem <i>subsys</i> . The block diagram and subsystem must have already been loaded. The subsystem cannot be part of the block diagram. The function affects only blocks, lines, and annotations; it does not affect nongraphical information such as configuration sets. You can use this function to convert a referenced model derived from an atomic subsystem into an atomic subsystem that is equivalent to the original subsystem.
<b>Limitation</b>	<code>Simulink.BlockDiagram.copyContentsToSubSystem</code> cannot be used if the destination subsystem contains any blocks or signals. Other types of information can exist in the destination subsystem and are not affected by the function. Use <code>Simulink.SubSystem.deleteContents</code> if necessary to empty the subsystem before using <code>Simulink.BlockDiagram.copyContentsToSubSystem</code> .
<b>Example</b>	If two block diagrams exist, <code>f14</code> and <code>f16</code> , and <code>f16</code> contains an empty subsystem named <code>f14cp</code> , the following code copies the contents of <code>f14</code> , including all nested subsystems, to <code>f16/f14cp</code> . Nongraphical information in <code>f14</code> is not copied.

```
% open f14 and f16
open_system('f14');
open_system('f16');

% copy the block diagram f14 to an empty subsystem of f16 named f14cp
```

# Simulink.BlockDiagram.copyContentsToSubSystem

---

```
Simulink.BlockDiagram.copyContentsToSubsystem('f14', 'f16/f14cp');  
  
% close f14 and f16  
close_system('f14', 0);  
close_system('f16', 0);
```

## See Also

Simulink.BlockDiagram.deleteContents  
Simulink.SubSystem.convertToModelReference  
Simulink.SubSystem.copyContentsToBlockDiagram  
Simulink.SubSystem.deleteContents

# Simulink.BlockDiagram.deleteContents

---

<b>Purpose</b>	Delete contents of block diagram
<b>Syntax</b>	<code>Simulink.BlockDiagram.deleteContents(<i>bdiag</i>)</code>
<b>Arguments</b>	<i>bdiag</i> Block diagram name or handle
<b>Description</b>	<code>Simulink.BlockDiagram.deleteContents</code> deletes the contents of the block diagram <i>bdiag</i> . The block diagram must have already been loaded. The function affects only blocks, lines, and annotations; it does not affect nongraphical information such as configuration sets.
<b>Example</b>	<p>If an open block diagram named <code>f14</code> exists, the following code deletes the graphical contents of <code>f14</code>, including all subsystems. Nongraphical information in <code>f14</code> is unaffected.</p> <pre>Simulink.BlockDiagram.deleteContents('f14');</pre>
<b>See Also</b>	<code>Simulink.BlockDiagram.copyContentsToSubSystem</code> <code>Simulink.SubSystem.convertToModelReference</code> <code>Simulink.SubSystem.copyContentsToBlockDiagram</code> <code>Simulink.SubSystem.deleteContents</code>

# Simulink.BlockDiagram.getChecksum

---

**Purpose** Return checksum of model

**Syntax** `[checksum,details] = Simulink.BlockDiagram.getChecksum mdl)`

**Description** `[checksum,details] = Simulink.BlockDiagram.getChecksum mdl)` returns the checksum of the specified model. Simulink computes the checksum based on attributes of the model and the blocks the model contains.

One use of this command is to determine why the Accelerator mode in Simulink regenerates code. For an example, see the demo `slAccelDemoWhyRebuild`.

---

**Note** `Simulink.BlockDiagram.getChecksum` compiles the specified model, using the command `model([], [], [], 'compileForRTW')`, if the model is not already in a compiled state. To get the checksum for the model when Simulink compiles it for simulation, use the command `model([], [], [], 'compile')` to place the model in a compiled state before using `Simulink.BlockDiagram.getChecksum`.

---

This command accepts the argument `mdl`, which is the full name or handle of the model for which you are returning checksum data.

This command returns the following output:

- `checksum` — Array of four 32-bit integers that represents the model's 128-bit checksum.
- `details` — Structure of the form

```
ContentsChecksum: [1x1 struct]
InterfaceChecksum: [1x1 struct]
ContentsChecksumItems: [nx1 struct]
InterfaceChecksumItems: [mx1 struct]
```

- ContentsChecksum — Structure of the following form that represents a checksum that provides information about all blocks in the model.

```
Value: [4x1 uint32]
MarkedUnique: [bool]
```

- Value — Array of four 32-bit integers that represents the model's 128-bit checksum.
  - MarkedUnique — True if any blocks in the model have a property that prevents code reuse.
- InterfaceChecksum — Structure of the following form that represents a checksum that provides information about the model.

```
Value: [4x1 uint32]
MarkedUnique: [bool]
```

- Value — Array of four 32-bit integers that represents the model's 128-bit checksum.
  - MarkedUnique — Always true. Present for consistency with ContentsChecksum structure.
- ContentsChecksumItems and InterfaceChecksumItems — Structure arrays of the following form that contain information that Simulink uses to compute the checksum for ContentsChecksum and InterfaceChecksum, respectively:

```
Handle: [char array]
Identifier: [char array]
Value: [type]
```

- Handle — Object for which Simulink added an item to the checksum. For a block, the handle is a full block path. For a block port, the handle is the full block path and a string that identifies the port.

# Simulink.BlockDiagram.getChecksum

---

- **Identifier** — Descriptor of the item Simulink added to the checksum. If the item is a documented parameter, the identifier is the parameter name.
- **Value** — Value of the item Simulink added to the checksum. If the item is a parameter, Value is the value returned by

`get_param(handle, identifier)`

## See Also

`Simulink.SubSystem.getChecksum`



**Purpose** Return initial state structure of block diagram

**Syntax** `x0 = Simulink.BlockDiagram.getInitialState(md1)`

**Description** `x0 = Simulink.BlockDiagram.getInitialState(md1)` returns the initial state structure of the block diagram specified by the input argument `md1`. This state structure can be used to specify the initial state vector in the **Configuration Parameters** dialog box or to provide an initial state condition to the linearization commands.

The command returns `x0`, a structure of the form

```
time: 0
signals: [1xn struct]
```

where `n` is the number of states contained in the model, including any models referenced by Model blocks. The `signals` field is a structure of the form

```
values: [1xm double]
dimensions: [1x1 double]
label: [char array]
blockName: [char array]
inReferencedModel: [bool]
sampleTime: [1x2 double]
```

- `values` — Numeric array of length `m`, where `m` is the number of states in the signal
- `dimensions` — Length of the values vector
- `label` — Indication of whether the state is continuous (CSTATE) or discrete (DSTATE)
- `blockName` — Full path to block associated with this state
- `inReferencedModel` — Indication of whether the state originates in a model referenced by a Model block (1) or in the top-level model (0)

# Simulink.BlockDiagram.getInitialState

---

- `sampleTime` — Array containing the sample time and offset of the state.

Using the state structure simplifies specifying initial state values for models with multiple states, as each state is associated with the full path to its parent block.

## See Also

`linmod`

<b>Purpose</b>	Convert cell array containing bus information to bus objects
<b>Syntax</b>	<code>Simulink.Bus.cellToObject(<i>busCell</i>)</code>
<b>Description</b>	<code>Simulink.Bus.cellToObject(busCell)</code> creates a set of bus objects in the MATLAB base workspace from a cell array of bus information.
<b>See Also</b>	<code>Simulink.Bus.save</code> , <code>Simulink.Bus.objectToCell</code>

# Simulink.Bus.createObject

---

**Purpose** Create bus objects for blocks

**Syntax**

```
busInfo = Simulink.Bus.createObject(model, blks)
busInfo = Simulink.Bus.createObject(model, blks, 'fileName')
busInfo = Simulink.Bus.createObject(model, blks, 'fileName',
    'format')
```

**Description** `Simulink.Bus.createObject(model, blks, 'fileName', 'format')` creates bus objects, i.e., instances of `Simulink.Bus` class, in the MATLAB workspace for specified blocks and optionally saves the bus objects in an M-file. The function accepts the following arguments:

- *model* — Name or handle of a model
- *blks* — List of subsystem-level Inport blocks, root-level or subsystem-level Outport blocks or Bus Creator blocks in the specified model. If only one block needs to be specified, this argument can be the full pathname of the block. Otherwise, this argument can be either a cell array containing block pathnames or a vector of block handles.
- *'fileName'* — Name of the file in which to save the bus objects created by this function. If this argument is omitted, this function does not save the created bus objects in a file.
- *'format'* — Format used to store the bus objects. May be `'cell'` or `'object'` or omitted in which case `'cell'` is assumed. Use cell array format to save the objects in a compact form.

This function returns a structure array containing bus information for the specified blocks. Each element of the structure array corresponds to one of the specified blocks and contains the following fields:

- `block` — Handle of the block
- `busName` — Name of the bus object associated with the block

**See Also** `Simulink.Bus.cellToObject`, `Simulink.Bus.save`

**Purpose** Convert bus objects to cell array containing bus information

**Syntax** `Simulink.Bus.objectToCell(busNames)`

**Description** `Simulink.Bus.objectToCell(busNames)` creates a cell array of cell arrays that contains bus information from a set of bus objects in the MATLAB base workspace. Each element of the cell array represents a bus object that has been converted.

The argument *busNames* is a cell array of bus object names to convert to cell arrays. If the specified array is empty, the function converts all bus objects in the base workspace.

The function converts each bus object to a cell array with the following data:

```
{BusName, HeaderFile, Description,  
BusElements}
```

The *BusElements* field is an array containing the following data for each element:

```
{ElementName, Dimensions, DataType,  
SampleTime, Complexity, SamplingMode}
```

**See Also** `Simulink.Bus.save`, `Simulink.Bus.cellToObject`

# Simulink.Bus.save

---

**Purpose** Save bus objects in M-file

**Syntax**

```
Simulink.Bus.save('fileName')  
Simulink.Bus.save('fileName', 'format')  
Simulink.Bus.save('fileName', 'format', busNames)
```

**Description** `Simulink.Bus.save('fileName', 'format', busNames)` saves bus objects, i.e., instances of `Simulink.Bus` class, residing in the MATLAB workspace in an M-file. Executing the M-file restores the objects to the workspace. This function takes the following arguments:

- `'fileName'` — Name of the file in which to store the bus objects
- `'format'` — Format used to store the bus objects. May be `'cell'` or `'object'` or omitted in which case `'cell'` is assumed. Use cell array format to save the objects in a compact form.

When the M-file generated for the `'cell'` format executes, it

- Calls `Simulink.Bus.cellToObject` to recreate the bus objects
- Returns the new bus objects in the cell array

To suppress the creation of bus objects, specify the optional argument `'false'` when you execute the M-file.

- `busNames` — A cell array containing names of bus objects to be saved. If the cell array is empty or omitted, this function saves all bus objects in the MATLAB workspace.

**See also** `Simulink.Bus.cellToObject`

# Simulink.SubSystem.convertToModelReference

---

**Purpose** Convert atomic subsystem or function call subsystem to model reference

**Syntax** `[success,mdlRefBlkH] =  
Simulink.SubSystem.convertToModelReference(subsys,  
mdlRef, 'opt1', 'val1', 'opt2', 'val2', ...)`

**Description** `[success,mdlRefBlkH] =  
Simulink.SubSystem.convertToModelReference(subsys, mdlRef,  
'opt1', 'val1', 'opt2', 'val2', ...)` converts an atomic subsystem or function call subsystem to a referenced model. The function does this by creating a new model, copying the contents of the subsystem into the model, and configuring the root level Inport and Outport blocks and configuration parameters of the new model. Then, based on its input arguments, the function either replaces the subsystem block with a Model block that references the new model, or it creates another, temporary model containing a Model block that references the new model.

---

**Note** Execute

```
sldemo_md1ref_conversion
```

at the MATLAB command line for a demonstration of this command's usage.

---

Converting a subsystem to a referenced model requires your model to have the following configuration parameter settings:

- The **Inline parameters** option in the **Optimization** pane must be On.
- The **Signal resolution** option in the **Data Validity** diagnostics pane must be set to `Explicit` only.
- The **Mux blocks used to create bus signals** diagnostic in the **Connectivity** diagnostics pane must be set to `Error`.

# Simulink.SubSystem.convertToModelReference

---

You can use the following commands to set these parameters to the values required by this function:

```
set_param(md1Name, 'InlineParams', 'on');  
set_param(md1Name, 'SignalResolutionControl', 'UseLocalSettings');  
set_param(md1Name, 'StrictBusMsg', 'ErrorLevel1');
```

---

**Note** This function produces error or warning messages for models and subsystems that it cannot handle. Even if conversion is successful, you may still need to reconfigure the resulting model to meet your requirements.

---

This function accepts the following arguments:

- *subsys* — Full name or handle of the atomic subsystem block to be converted
- *mdlRef* — Name of the model to which the subsystem is to be converted
- '*opt1*', '*val1*', '*opt2*', '*val2*'... — parameter/value pairs that specify various conversion options. This function support the following option pairs:
  - 'ReplaceSubsystem', [true|false] — If the option value is true, this function replaces the subsystem block with a Model block that references the model created from the subsystem. If you do not specify this option or specify its value as false, this function creates and opens a model containing a Model block that references the model derived from the subsystem block.
  - 'BusSaveFormat', ['Cell' | 'Object'] — If this option is specified, the function saves the bus objects that it creates in an M-file. See `Simulink.Bus.save` for more information.
  - 'BuildTarget', ['Sim' | 'RTW'] — If you specify this option, this function generates a model reference Sim or RTW target for the new model.



- 'Force', [true|{false}] — If this parameter is true, this function reports some errors that would halt the conversion process as warnings and continues with the conversion. This allows you to use this function to do the initial steps of conversion and then complete the conversion process yourself. If you do not specify this option or specify it as false, this function halts the conversion if an error occurs.

This function returns the following outputs:

- *success* — True if this function is successful; otherwise, false.
- *mdlRefBlkH* — Handle of the Model block that references the new model

## See Also

`Simulink.BlockDiagram.copyContentsToSubSystem`

`Simulink.Bus.save`

`Simulink.SubSystem.copyContentsToBlockDiagram`

“Converting a Subsystem to a Referenced Model”

# Simulink.SubSystem.copyContentsToBlockDiagram

---

<b>Purpose</b>	Copy contents of subsystem to empty block diagram
<b>Syntax</b>	<code>Simulink.SubSystem.copyContentsToBlockDiagram(<i>subsys</i>, <i>bdiag</i>)</code>
<b>Arguments</b>	<i>subsys</i> Subsystem name or handle  <i>bdiag</i> Block diagram name or handle
<b>Description</b>	<code>Simulink.SubSystem.copyContentsToBlockDiagram</code> copies the contents of the subsystem <i>subsys</i> to the block diagram <i>bdiag</i> . The subsystem and block diagram must have already been loaded. The subsystem cannot be part of the block diagram. The function affects only blocks, lines, and annotations; it does not affect nongraphical information such as configuration sets.
<b>Limitation</b>	<code>Simulink.SubSystem.copyContentsToBlockDiagram</code> cannot be used if the destination block diagram contains any blocks or signals. Other types of information can exist in the destination block diagram and are unaffected by the function. Use <code>Simulink.BlockDiagram.deleteContents</code> if necessary to empty the block diagram before using <code>Simulink.SubSystem.copyContentsToBlockDiagram</code> .
<b>Example</b>	If a block diagram named <code>f14</code> has a subsystem named <code>Controller</code> , the following code copies the graphical contents of <code>Controller</code> , including all nested subsystems, to a new block diagram. Nongraphical information in <code>Controller</code> is not copied.  <pre>% open f14 open_system('f14');  % create a new model newbd = new_system; open_system(newbd);</pre>

# Simulink.SubSystem.copyContentsToBlockDiagram

---

```
% copy the subsystem
Simulink.SubSystem.copyContentsToBlockDiagram('f14/Controller', newbd);

% close f14 and the new model
close_system('f14', 0);
close_system(newbd, 0);
```

## See Also

Simulink.BlockDiagram.copyContentsToSubSystem  
Simulink.BlockDiagram.deleteContents  
Simulink.SubSystem.convertToModelReference  
Simulink.SubSystem.deleteContents

# Simulink.SubSystem.deleteContents

---

**Purpose** Delete contents of subsystem

**Syntax** `Simulink.SubSystem.deleteContents(subsys)`

**Arguments** *subsys*  
Subsystem name or handle

**Description** `Simulink.SubSystem.deleteContents` deletes the contents of the subsystem *subsys*. The subsystem must have already been loaded. The function affects only blocks, lines, and annotations; it does not affect nongraphical information such as configuration sets.

**Example** If an open block diagram named `f14` has a subsystem named `Controller`, the following code deletes the graphical contents of `Controller`, including all nested subsystems. Nongraphical information in `Controller` remains unchanged.

```
Simulink.SubSystem.deleteContents('f14/Controller');
```

**See Also** `Simulink.BlockDiagram.copyContentsToSubSystem`  
`Simulink.BlockDiagram.deleteContents`  
`Simulink.SubSystem.convertToModelReference`  
`Simulink.SubSystem.copyContentsToBlockDiagram`

**Purpose** Return checksum of subsystem

**Syntax** `[checksum,details] = Simulink.SubSystem.getChecksum(subsys)`

**Description** `[checksum,details] = Simulink.SubSystem.getChecksum(subsys)` returns the checksum of the specified subsystem. Simulink computes the checksum based on subsystem parameter settings and the blocks the subsystem contains.

One use of this command is to determine why code generated for a subsystem is not being reused. For an example, see “Determining Why Subsystem Code Is Not Reused” in the Real-Time Workshop documentation.

---

**Note** `Simulink.SubSystem.getChecksum` compiles the model that contains the specified subsystem, using the command `model([], [], [], 'compileForRTW')`, if the model is not already in a compiled state. To get the checksum for the model when Simulink compiles it for simulation, use the command `model([], [], [], 'compile')` to place the model in a compiled state before using `Simulink.SubSystem.getChecksum`.

---

This command accepts the argument `subsys`, which is the full name or handle of the atomic subsystem block for which you are returning checksum data.

This command returns the following output:

- `checksum` — Structure of the form

Value: [4x1 uint32]  
MarkedUnique: [bool]

- Value — Array of four 32-bit integers that represents the subsystem’s 128-bit checksum.

# Simulink.SubSystem.getChecksum

---

- `MarkedUnique` — True if the subsystem or the blocks it contains have properties that would prevent the code generated for the subsystem from being reused; otherwise, false.
- `details` — Structure of the form

```
ContentsChecksum: [1x1 struct]
InterfaceChecksum: [1x1 struct]
ContentsChecksumItems: [nx1 struct]
InterfaceChecksumItems: [mx1 struct]
```

- `ContentsChecksum` — Structure of the same form as `checksum`, representing a checksum that provides information about all blocks in the system.
- `InterfaceChecksum` — Structure of the same form as `checksum`, representing a checksum that provides information about the subsystem's block parameters and connections.
- `ContentsChecksumItems` and `InterfaceChecksumItems` — Structure arrays of the following form that Simulink uses to compute the checksum for `ContentsChecksum` and `InterfaceChecksum`, respectively:

```
Handle: [char array]
Identifier: [char array]
Value: [type]
```

- `Handle` — Object for which Simulink added an item to the checksum. For a block, the handle is a full block path. For a block port, the handle is the full block path and a string that identifies the port.
- `Identifier` — Descriptor of the item Simulink added to the checksum. If the item is a documented parameter, the identifier is the parameter name.
- `Value` — Value of the item Simulink added to the checksum. If the item is a parameter, `Value` is the value returned by

# Simulink.SubSystem.getChecksum

---

`get_param(handle, identifier)`

## See Also

`Simulink.BlockDiagram.getChecksum`

# sint

---

**Purpose** Create MATLAB structure describing signed integer data type

**Syntax** `a = sint(TotalBits)`

**Description** `sint(TotalBits)` returns a MATLAB structure that describes the data type of a signed integer with a word size given by `TotalBits`.

`sint` is automatically called when a signed integer is specified in a block dialog box.

The default binary point for this data type is assumed to lie to the right of all bits.

**Examples** Define a 16-bit signed integer data type:

```
a = sint(16)
a =
    Class: 'INT'
   IsSigned: 1
  MantBits: 16
```

**See Also** `fixdt`, `float`, `sfix`, `sfrac`, `ufix`, `ufrac`, `uint`



**Purpose**

Build standalone and model reference targets

**Syntax**

```
slbuild('model')  
slbuild('model', 'ModelReferenceSimTarget')  
slbuild('model', 'ModelReferenceRTWTarget')  
slbuild('model', 'ModelReferenceRTWTargetOnly')
```

**Description**

---

**Note** Except where noted, this command requires a Real-Time Workshop license.

---

`slbuild('model')` builds a standalone executable from `model`, using the model's Real-Time Workshop configuration settings.

---

**Note** The following commands honor the setting of the **Rebuild options** on the **Model Referencing** pane of the **Configuration Parameters** dialog for rebuilding the model reference target for this model and its referenced models.

---

`slbuild('model', 'ModelReferenceSimTarget')` builds a model reference simulation target for the model. This command does not require a Real-Time Workshop license.

`slbuild('model', 'ModelReferenceRTWTarget')` builds model reference simulation and Real-Time Workshop targets for `model`.

`slbuild('model', 'ModelReferenceRTWTargetOnly')` builds a model reference RTW target for the model.

If the **Rebuild option** on the **Model Referencing** pane of the **Configuration Parameters** dialog is set to Never, you can use two additional arguments, 'UpdateThisModelReferenceTarget' and 'Buildcond', to specify a rebuild option for building a model reference target for this 'model'. For example,

```
slbuild('model','ModelReferenceSimTarget', ...  
        'UpdateThisModelReferenceTarget', Buildcond)
```

conditionally builds the simulation target for this *'model'* based on the value of *Buildcond*.

---

**Note** This option does not rebuild model reference targets for models referenced by this model.

---

*'Buildcond'* must be one of the following:

- *'IfOutOfDateOrStructuralChange'*

Causes *slbuild* to rebuild this model if it detects any changes. This option is equivalent to the **If any changes detected rebuild** option on the **Model Referencing** pane of the **Configuration Parameters** dialog box.

- *'IfOutOfDate'*

Causes *slbuild* to rebuild this model if it detects any changes in known dependencies of this model. This option is equivalent to the **If any changes in known dependencies detected rebuild** option on the **Model Referencing** pane of the **Configuration Parameters** dialog box.

- *'Force'*

Causes *slbuild* to always rebuild the model. This option is equivalent to the **"Always"** rebuild option on the **Model Referencing** pane of the **Configuration Parameters** dialog box.

**Purpose** Change MATLAB character set encoding

**Syntax** `slCharacterEncoding()`  
`slCharacterEncoding(encoding)`

**Description** This command allows you to change the current MATLAB character set encoding to be compatible with the encoding of a model that you want to open.

`slCharacterEncoding()` returns the current MATLAB character set encoding.

`slCharacterEncoding(encoding)` change the MATLAB character set encoding to the specified encoding. Valid values include:

- 'US-ASCII'
- 'UTF-8'
- 'Shift\_JIS'
- 'ISO-8859-1'

To display a complete list of the names of character set encodings supported by MATLAB and the characters supported by the encodings, use the ICU Converter Explorer developed by IBM Corp. and available on the Internet. The first column of the ICU Converter Explorer lists the primary names of the character sets supported by MATLAB. The remaining columns list aliases for the character sets.

# sICharacterEncoding

---

The `sICharacterEncoding` command accepts the aliases as well as the primary names of character sets. To display a table listing the characters supported by a character set and the encodings for the characters, click the character set's primary name in the ICU Converter Explorer.

---

**Note** You must close all open models or libraries before changing the MATLAB character set encoding except when changing from 'US-ASCII' to another encoding.

---

**Purpose** Start simulation in debug mode

**Syntax** `sldebug('sys')`

**Description** `sldebug('sys')` starts a simulation in debug mode. See “Simulink Debugger” in the Simulink documentation and Chapter 6, “Simulink Debugger Commands” in the Simulink Reference for information about using the debugger.

**Examples** The following command:

```
sldebug('vdp')
```

loads the Simulink demo model `vdp` into memory and starts the simulation in debug mode. Alternatively, you can achieve the same result by using both the `sim` and `simset` commands:

```
sim('vdp', [0,10], simset('debug', 'on'))
```

**See Also** `sim`, `simset`

# sldiagnostics

---

**Purpose** Display diagnostic information about Simulink system

**Syntax** `[txtRpt, sRpt] = sldiagnostics('sys')`  
`[txtRpt, sRpt] = sldiagnostics('sys', options)`

**Description** `sldiagnostics('sys')` displays the following diagnostic information associated with the model or subsystem specified by `sys`:

- Number of each type of block
- Number of each type of Stateflow object
- Number of states, outputs, inputs, and sample times
- Names of libraries referenced and instances of the referenced blocks
- Time and additional memory used for each compilation phase of the root model

If the model specified by `sys` is not loaded, `sldiagnostics` loads the model, completes the diagnostics, and then closes the model. If `sys` is a subsystem, the root model must be loaded for `sldiagnostics` to operate successfully.

---

**Note** To see memory usage, you must first enable the memory integrity checking option in MATLAB at startup. This is accomplished by running MATLAB with the `-check_malloc` flag. For more information about this startup option, see `matlab` (Windows) or `matlab` (UNIX) in the MATLAB Function Reference.

---

`sldiagnostics('sys', options)` displays only the diagnostic information associated with the specific operations listed as `options` strings. The available options and their output are as follows:

Option	Description
CountBlocks	Lists all unique blocks in the system and the number of occurrences of each. This includes blocks that are nested in masked subsystems or hidden blocks.
CountSF	Lists all unique Stateflow objects in the system and the number of occurrences of each.
Sizes	Lists the number of states, outputs, inputs, and sample times, as well as a flag indicating direct feedthrough, used in the root model.
Libs	Lists all unique libraries referenced in the root model, as well as the names and numbers of the library blocks.
CompileStats	Lists the time and additional memory used for each compilation phase of the root model. The memory usage is displayed when the memory integrity checking option is enabled in MATLAB at startup. This information helps users troubleshoot model compilation speed and memory issues.
Verbose	Lists the results of the CompileStats diagnostic during the compilation phase. This is useful for diagnosing the compilation itself if it takes an unreasonable amount of time or hangs.
RTWBuildStats	Lists the same information as the CompileStats diagnostic. When issued with the second output argument <code>sRpt</code> , it captures the Real-Time Workshop build statistics in <code>sRpt.rtwbuild</code> .
All	Performs all diagnostics.

---

**Note** Running the CompileStats diagnostic before simulating a model for the first time will show greater memory usage. However, subsequent runs of the CompileStats diagnostic on the model will return a lesser amount of memory usage.

---

`[txtRpt, sRpt] = sldiagnostics('sys')` or `[txtRpt, sRpt] = sldiagnostics('sys', options)` returns the diagnostic information as a textual report `txtRpt` and a structure array `sRpt`, which contains the following fields that correspond to the diagnostic options:

- blocks
- stateflow
- sizes
- links
- compilestats
- rtwbuild

## Examples

The following command counts and lists each type of block used in the `sldemo_bounce` model that comes with Simulink.

```
sldiagnostics('sldemo_bounce', 'CountBlocks')
```

The following command counts and lists both the unique blocks and Stateflow objects used in the `sf_boiler` model that comes with Stateflow; the textual report returned is captured as `myReport`.

```
myReport = sldiagnostics('sf_boiler', 'CountBlocks', 'CountSF')
```

The following commands open the `f14` model that comes with Simulink, and counts the number of blocks used in the Controller subsystem.

```
f14; sldiagnostics('f14/Controller', 'CountBlocks')
```



The following command runs the `Sizes` and `CompileStats` diagnostics on the `f14` model, capturing the results as both a textual report and structure array.

```
[txtRpt, sRpt] = sldiagnostics('f14', 'Sizes', 'CompileStats')
```

## See Also

`find_system`, `get_param`

# sldiscmdl

---

**Purpose** Discretize Simulink model containing continuous blocks

**Syntax**

```
sldiscmdl('sys',sampletime)
sldiscmdl('sys',sampletime,'method')
sldiscmdl('sys',sampletime,{options})
sldiscmdl('sys',sampletime,'method',cf)
sldiscmdl('sys',sampletime,'method',{options})
sldiscmdl('sys',sampletime,'method',cf,{options})
```

**Description** `sldiscmdl('sys',sampletime)` discretizes the model specified by 'sys' and sampletime. You can enter a sample time and an offset as a two-element vector for sampletime. The units for sampletime are seconds.

`sldiscmdl('sys',sampletime,'method')` discretizes the model with the transform method specified by 'method'. Available values for 'method' are shown below:

Value	Description
'zoh'	Zero-order hold on the inputs (the default if you do not specify a method)
'foh'	First-order hold on the inputs
'tustin'	Bilinear (Tustin) approximation
'prewarp'	Tustin approximation with frequency prewarping
'matched'	Matched pole-zero method (for SISO systems only)

`sldiscmdl('sys',sampletime,{options})` discretizes the model with the criteria specified by {options}, where {options} is a cell array containing the following string elements:

```
{'target','ReplaceWith','PutInto','prompt'}
```

Available values for 'target' are shown below:

<b>Value</b>	<b>Description</b>
'all'	Discretize all continuous blocks
'selected'	Discretize selected blocks only
'<full path name of block>'	Discretize specified block

Available values for 'ReplaceWith' are shown below:

<b>Value</b>	<b>Description</b>
'parammask'	Create discrete blocks whose parameters are retained from the corresponding continuous block
'hardcoded'	Create discrete blocks whose parameters are "hard_coded" values placed directly into the block's dialog box.

Available values for 'PutInto' are shown below:

<b>Value</b>	<b>Description</b>
'current'	Apply discretization to current model
'configurable'	Create discretization candidate in a configurable subsystem
'untitled'	Create discretization in a new untitled window
'copy'	Create discretization in copy of the original model

Available values for 'prompt' are shown below:

Value	Description
'on'	Show the discretization information
'off'	Do not show the discretization information

`sldiscmdl('sys',sampletime,'method',cf)` discretizes the model with the critical frequency specified by `cf`. The units for `cf` are Hz. This is only used when the transform method is 'prewarp'.

## Examples

This command discretizes all of the continuous blocks in the `f14` model with a 1 second sample time.

```
sldiscmdl('f14',1.0)
```

This command discretizes the Controller subsystem in the `f14` model using a first-order hold transform method with a 1-second sample time and a 0.1-second sample time offset. The discretized block has "hard-coded" parameters that are placed directly into the block's dialog box.

```
sldiscmdl('f14',[1.0 0.1],'foh',{'f14/Controller',...  
'hardcoded','copy','on'})
```

This command discretizes the Controller subsystem in the `f14` model using a zero-order hold transform method with a 1-second sample time and a 0.1-second sample time offset. It returns to the command window a cell array for the original continuous blocks in the system and a cell array for the discretized blocks in the system.

```
[a, b] = sldiscmdl('f14',[1.0 0.1],'zoh', {'f14/Controller',...
'hardcoded', 'copy', 'on'})
```

```
a =
```

```
    [1x43 char]    [1x37 char]    [1x53 char]    [1x30 char]
```

```
b =
```

```
    [1x43 char]    [1x37 char]    [1x53 char]    [1x30 char]
```

You can index into the cell arrays to get the new names of the discretized blocks and the original names of the continuous blocks.

For example, this command returns the name of the second discretized block.

```
b{2}
```

```
ans =
```

```
f14_disc_copy/Controller/Pitch Rate  
Lead Filter
```

# sIsFileChangedOnDisk

---

**Purpose** Determine whether model has changed since it was loaded

**Syntax** `Changed = sIsFileChangedOnDisk(sys)`

**Description** `Changed = sIsFileChangedOnDisk(sys)` Returns true if the file which contains block diagram `sys` was changed on disk since the block diagram was loaded.

**Example** To ensure that code is not generated for a model whose file has changed on disk since it was loaded, include the following in the 'entry' section of the `STF_make_rtw_hook.m` file:

```
if (sIsFileChangedOnDisk(sys))
    error('File has changed on disk since it was loaded. Aborting code generation.');
```

end

**See Also** “Customizing the Target Build Process with the `STF_make_rtw` Hook File”

“Model File Change Notification”

**Purpose** Open Model Discretizer GUI

**Syntax** `slmdliscui('name')`

**Description** `slmdliscui('name')` opens the Model Discretizer with the library or model specified by 'name'.

**Examples** This command opens the Model Discretizer with the f14 model.

```
slmdliscui('f14')
```

This command opens the Model Discretizer with the library named Test.

```
slmdliscui('Test')
```

# slreplace\_mux

---

**Purpose** Replace Mux blocks used to create buses with Bus Creator blocks

**Syntax** [muxes, uniqueMuxes, uniqueBds] = slreplace\_mux(model, reportonly)

**Description** slreplace\_mux(model) or slreplace\_mux(model, true) reports all Mux blocks that create buses in model and in libraries referenced by model.

A signal created by a Mux block is a bus if the signal meets either or both of the following conditions:

- A Bus Selector block individually selects one or more of the signal's elements (as opposed to the entire signal).
- The signal's components have different data types, numeric types (complex or real), dimensionality, storage classes, or sampling modes.

---

**Note** Before running this command, you should set the **Mux blocks used to create bus signals** connectivity diagnostic to warning or none. See “Connectivity Diagnostics Overview” for more information.

---

slreplace\_mux(model, false) replaces all Mux blocks in model that create buses, including Mux blocks in libraries, with Bus Creator blocks. This command saves the model, if changed, and saves and closes any library that it modifies.

---

**Note** You should make a backup copy of your model and libraries before using this form of the command because it is difficult to undo its effects.

---



`[muxes, uniqueMuxes, uniqueBds] = slreplace_mux(model)`  
returns the following output variables:

- `muxes`

All Mux blocks used as Bus Creators in the model and in libraries referenced by the model

- `uniqueMuxes`

All Mux blocks used as Bus Creators in the model and in libraries referenced by the model except blocks in the model that are copies of blocks in libraries

- `uniqueBds`

Models and libraries that use Mux blocks as Bus Creators

# slupdate

---

**Purpose** Replace blocks from previous releases with latest versions

**Syntax**

```
slupdate('sys')  
slupdate('sys', prompt)  
slupdate('sys', 'OperatingMode', 'Analyze')
```

**Description** `slupdate('sys')` replaces blocks in model `sys` from a previous release of Simulink with the latest versions.

---

**Note** The model to be updated must be open when you call `slupdate`.

---

`slupdate('sys', prompt)` specifies whether to prompt you before replacing a block. If *prompt* equals 1, the command prompts you before replacing the block. The prompt asks whether you want to replace the block. Valid responses are

- y  
Replace the block (the default).
- n  
Do not replace the block.
- a  
Replace this and all subsequent obsolete blocks without further prompting.

If *prompt* equals 0, the command replaces all obsolete blocks without prompting you.

In addition to replacing obsolete blocks, `slupdate`

- Reconnects broken links to masked blocks in libraries provided by the MathWorks to ensure that the model reflects changes made to the blocks in this release. This will overwrite any customizations that you have made to the masks of these blocks.

- Updates obsolete configuration settings for the model.

`slupdate('sys', 'OperatingMode', 'Analyze')` performs only the analysis portion without updating or changing the model. This command analyzes referenced models, linked libraries, and S-functions, and then returns a data structure with the following fields:

- `Message` — string containing a message summarizing the results
- `blockList` — cell array listing blocks that need to be updated
- `blockReasons` — cell array listing reasons for updating the corresponding blocks
- `modelList` — cell array listing referenced models and the parent model
- `libraryList` — cell array listing non-MathWorks libraries referenced
- `configSetList` — for internal use
- `sfunList` — cell array listing S-functions referenced
- `sfunOK` — logical array representing S-function status, where `false` indicates that an S-function needs updating and `true` indicates otherwise
- `sfunType` — cell array listing apparent S-function type (e.g., `m`, `mex`)

## Purpose

Find trim point of dynamic system

## Syntax

```
[x,u,y,dx] = trim('sys')
[x,u,y,dx] = trim('sys',x0,u0,y0)
[x,u,y,dx] = trim('sys',x0,u0,y0,ix,iu,iy)
[x,u,y,dx] = trim('sys',x0,u0,y0,ix,iu,iy,dx0,idx)
[x,u,y,dx,options] = trim('sys',x0,u0,y0,ix,iu,iy,dx0,idx,
    options)
[x,u,y,dx,options] = trim('sys',x0,u0,y0,ix,iu,iy,dx0,idx,
    options,t)
```

## Description

A trim point, also known as an equilibrium point, is a point in the parameter space of a dynamic system at which the system is in a steady state. For example, a trim point of an aircraft is a setting of its controls that causes the aircraft to fly straight and level. Mathematically, a trim point is a point where the system's state derivatives equal zero. `trim` starts from an initial point and searches, using a sequential quadratic programming algorithm, until it finds the nearest trim point. You must supply the initial point implicitly or explicitly. If `trim` cannot find a trim point, it returns the point encountered in its search where the state derivatives are closest to zero in a min-max sense; that is, it returns the point that minimizes the maximum deviation from zero of the derivatives. `trim` can find trim points that meet specific input, output, or state conditions, and it can find points where a system is changing in a specified manner, that is, points where the system's state derivatives equal specific nonzero values.

`[x,u,y,dx] = trim('sys')` finds the equilibrium point nearest to the system's initial state, `x0`. Specifically, `trim` finds the equilibrium point that minimizes the maximum absolute value of  $[x-x_0, u, y]$ . If `trim` cannot find an equilibrium point near the system's initial state, it returns the point at which the system is nearest to equilibrium. Specifically, it returns the point that minimizes  $\text{abs}(dx-0)$ . You can obtain `x0` using this command.

```
[sizes,x0,xstr] = sys([],[],[],0)
```

`[x,u,y,dx] = trim('sys',x0,u0,y0)` finds the trim point nearest to  $x_0$ ,  $u_0$ ,  $y_0$ , that is, the point that minimizes the maximum value of

$$\text{abs}([x-x_0; u-u_0; y-y_0])$$

`[x,u,y,dx] = trim('sys',x0,u0,y0,ix,iu,iy)` finds the trim point closest to  $x_0$ ,  $u_0$ ,  $y_0$  that satisfies a specified set of state, input, and/or output conditions. The integer vectors  $ix$ ,  $iu$ , and  $iy$  select the values in  $x_0$ ,  $u_0$ , and  $y_0$  that must be satisfied. If `trim` cannot find an equilibrium point that satisfies the specified set of conditions exactly, it returns the nearest point that satisfies the conditions, namely,

$$\text{abs}([x(ix)-x_0(ix); u(iu)-u_0(iu); y(iy)-y_0(iy)])$$

`[x,u,y,dx] = trim('sys',x0,u0,y0,ix,iu,iy,dx0,idx)` finds specific nonequilibrium points, that is, points at which the system's state derivatives have some specified nonzero value. Here,  $dx_0$  specifies the state derivative values at the search's starting point and  $idx$  selects the values in  $dx_0$  that the search must satisfy exactly.

`[x,u,y,dx,options] = trim('sys',x0,u0,y0,ix,iu,iy,dx0,idx,options)` specifies an array of optimization parameters that `trim` passes to the optimization function that it uses to find trim points. The optimization function, in turn, uses this array to control the optimization process and to return information about the process. `trim` returns the options array at the end of the search process. By exposing the underlying optimization process in this way, `trim` allows you to monitor and fine-tune the search for trim points.

The following table describes how each element affects the search for a trim point. Array elements 1, 2, 3, 4, and 10 are particularly useful for finding trim points.

# trim

No.	Default	Description
1	0	Specifies display options. 0 specifies no display; 1 specifies tabular output; -1 suppresses warning messages.
2	$10^{-4}$	Precision the computed trim point must attain to terminate the search.
3	$10^{-4}$	Precision the trim search goal function must attain to terminate the search.
4	$10^{-6}$	Precision the state derivatives must attain to terminate the search.
5	N/A	Not used.
6	N/A	Not used.
7	N/A	Used internally.
8	N/A	Returns the value of the trim search goal function ( $\lambda$ in goal attainment).
9	N/A	Not used.
10	N/A	Returns the number of iterations used to find a trim point.
11	N/A	Returns the number of function gradient evaluations.
12	0	Not used.
13	0	Number of equality constraints.
14	100*(Number of variables)	Maximum number of function evaluations to use to find a trim point.
15	N/A	Not used.
16	$10^{-8}$	Used internally.

No.	Default	Description
17	0.1	Used internally.
18	N/A	Returns the step length.

`[x,u,y,dx,options] = trim('sys',x0,u0,y0,ix,iu,iy,dx0,idx,options,t)` sets the time to `t` if the system is dependent on time.

## Examples

Consider a linear state-space model

$$\dot{x} = Ax + Bu$$

$$y = Cx + Du$$

The  $A$ ,  $B$ ,  $C$ , and  $D$  matrices are as follows in a system called `sys`.

$$A = [-0.09 \quad -0.01; \quad 1 \quad 0];$$

$$B = [ \quad 0 \quad -7; \quad 0 \quad -2];$$

$$C = [ \quad 0 \quad 2; \quad 1 \quad -5];$$

$$D = [-3 \quad 0; \quad 1 \quad 0];$$

### Example 1

To find an equilibrium point, use

```
[x,u,y,dx,options] = trim('sys')
x =
    0
    0
u =
    0
y =
    0
    0
dx =
    0
    0
```

The number of iterations taken is

```
options(10)
ans =
    7
```

## Example 2

To find an equilibrium point near  $x = [1;1]$ ,  $u = [1;1]$ , enter

```
x0 = [1;1];
u0 = [1;1];
[x,u,y,dx,options] = trim('sys', x0, u0);
x =
    1.0e-11 *
   -0.1167
   -0.1167
u =
    0.3333
    0.0000
y =
   -1.0000
    0.3333
dx =
    1.0e-11 *
    0.4214
    0.0003
```

The number of iterations taken is

```
options(10)
ans =
    25
```

## Example 3

To find an equilibrium point with the outputs fixed to 1, use



```
y = [1;1];
iy = [1;2];
[x,u,y,dx] = trim('sys', [], [], y, [], [], iy)
x =
    0.0009
   -0.3075
u =
   -0.5383
    0.0004
y =
    1.0000
    1.0000
dx =
    1.0e-16 *
   -0.0173
    0.2396
```

#### Example 4

To find an equilibrium point with the outputs fixed to 1 and the derivatives set to 0 and 1, use

```
y = [1;1];
iy = [1;2];
dx = [0;1];
idx = [1;2];
[x,u,y,dx,options] = trim('sys',[],[],y,[],[],iy,dx,idx)
x =
    0.9752
   -0.0827
u =
   -0.3884
   -0.0124
y =
    1.0000
    1.0000
dx =
```

# trim

---

```
0.0000  
1.0000
```

The number of iterations taken is

```
options(10)  
ans =  
    13
```

## Limitations

The trim point found by trim starting from any given initial point is only a local value. Other, more suitable trim points may exist. Thus, if you want to find the most suitable trim point for a particular application, it is important to try a number of initial guesses for  $x$ ,  $u$ , and  $y$ .

## Algorithm

trim uses a sequential quadratic programming algorithm to find trim points. See the *Optimization Toolbox User's Guide* for a description of this algorithm.

**Purpose** Create Simulink parameter objects from tunable parameters

**Syntax** `tunablevars2parameterobjects (modelName)`  
`tunablevars2parameterobjects (modelName, class)`

**Arguments**

*modelName*  
Model name or handle

*class*  
Parameter class to use for creating objects. Default: `Simulink.Parameter`.

**Description** This function creates Simulink parameter objects in the base workspace for the variables listed in a model's Tunable Parameters dialog, then deletes the source information from the dialog. To preserve the information, save the resulting Simulink parameter objects into a MAT-file.

If *class* is specified, the parameter objects are of that class. Otherwise, the parameter objects default to class `Simulink.Parameter`.

If a tunable variable is already defined as a numeric variable in the base workspace, the variable will be replaced by a parameter object and the original variable will be copied to the object's Value property.

If a tunable variable is already defined as a Simulink parameter object, the object will not be modified but the information for the variable will still be deleted from the Tunable Parameters dialog.

If a tunable variable is defined as any other class of variable, the variable will not be modified and the information for the variable will not be deleted from the Tunable Parameters dialog.

**See Also**

# ufix

---

**Purpose** Create MATLAB structure describing unsigned generalized fixed-point data type

**Syntax** `a = ufix(TotalBits)`

**Description** `ufix(TotalBits)` returns a MATLAB structure that describes the data type of an unsigned generalized fixed-point data type with a word size given by `TotalBits`.

`ufix` is automatically called when an unsigned generalized fixed-point data type is specified in a block dialog box.

---

**Note** The default binary point is not included in this data type description. Instead, the scaling must be explicitly defined in the block dialog box.

---

**Examples** Define a 16-bit unsigned generalized fixed-point data type:

```
a = ufix(16)
a =
    Class: 'FIX'
    IsSigned: 0
    MantBits: 16
```

**See Also** `fixdt`, `float`, `sfix`, `sfrac`, `sint`, `ufrac`, `uint`

---

<b>Purpose</b>	Create MATLAB structure describing unsigned fractional data type
<b>Syntax</b>	<pre>a = ufrac(TotalBits) a = ufrac(TotalBits, GuardBits)</pre>
<b>Description</b>	<p><code>ufrac(TotalBits)</code> returns a MATLAB structure that describes the data type of an unsigned fractional number with a word size given by <code>TotalBits</code>.</p> <p><code>ufrac(TotalBits, GuardBits)</code> returns a MATLAB structure that describes the data type of an unsigned fractional number. The total word size is given by <code>TotalBits</code> with <code>GuardBits</code> bits located to the left of the binary point.</p> <p><code>ufrac</code> is automatically called when an unsigned fractional data type is specified in a block dialog box.</p> <p>The default binary point for this data type is assumed to lie immediately to the left of all bits. If guard bits are specified, then they lie to the left the default binary point.</p>
<b>Examples</b>	<p>Define an 8-bit unsigned fractional data type with 4 guard bits. Note that the range of this number is from 0 to <math>(1 - 2^{-8}) \cdot 2^4 = 15.9375</math>:</p> <pre>a = ufrac(8,4) a =     Class: 'FRAC'     IsSigned: 0     MantBits: 8     GuardBits: 4</pre>
<b>See Also</b>	<code>fixdt</code> , <code>float</code> , <code>sfix</code> , <code>sfrac</code> , <code>sint</code> , <code>ufix</code> , <code>uint</code>

# uint

---

**Purpose** Create MATLAB structure describing unsigned integer data type

**Syntax** `a = uint(TotalBits)`

**Description** `uint(TotalBits)` returns a MATLAB structure that describes the data type of an unsigned integer with a word size given by `TotalBits`.

`uint` is automatically called when an unsigned integer is specified in a block dialog box.

The default binary point for this data type is assumed to lie to the right of all bits.

**Examples** Define a 16-bit unsigned integer:

```
a = uint(16)
a =
    Class: 'INT'
  IsSigned: 0
  MantBits: 16
```

**See Also** `fixdt`, `float`, `sfix`, `sfrac`, `sint`, `ufix`, `frac`

---

<b>Purpose</b>	Extract signal logging objects from signal logs and write them into MATLAB workspace
<b>Syntax</b>	<code>log.unpack</code> <code>tsarray.unpack</code> <code>log.unpack('systems')</code> <code>log.unpack('all')</code>
<b>Description</b>	<p><code>log.unpack</code> or <code>unpack(log)</code> extracts the top level elements of the <code>Simulink.ModelDataLogs</code> or <code>Simulink.SubsysDataLogs</code> object named <b>log</b> (e.g., <code>logout</code>).</p> <p><code>log.unpack('systems')</code> or <code>unpack(log, 'systems')</code> extracts <code>Simulink.Timeseries</code> and <code>Simulink.TsArray</code> objects from the <code>Simulink.ModelDataLogs</code> or <code>Simulink.SubsysDataLogs</code> object named <code>log</code>. This command does not extract <code>Simulink.Timeseries</code> objects from <code>Simulink.TsArray</code> objects nor does it write intermediate <code>Simulink.ModelDataLogs</code> or <code>Simulink.SubsysDataLogs</code> objects to the MATLAB workspace.</p> <p><code>log.unpack('all')</code> or <code>unpack(log, 'all')</code> extracts all the <code>Simulink.Timeseries</code> objects contained by the <code>Simulink.ModelDataLogs</code>, <code>Simulink.TsArray</code>, or <code>Simulink.SubsysDataLogs</code> object named <code>log</code>.</p> <p><code>tsarray.unpack</code> extracts the time-series objects of class <code>Simulink.Timeseries</code> from the <code>Simulink.TsArray</code> object named <code>tsarray</code>.</p>
<b>See Also</b>	<code>whos</code> , <code>who</code>

# view\_mdhrefs

---

**Purpose** Display graph of model reference dependencies

**Syntax** `view_mdhrefs('model_name')`

**Description** `view_mdhrefs('model_name')` launches the Model Dependency Viewer, which displays a graph of model reference dependencies for the model specified by `model_name`. The nodes in the graph represent Simulink models. The directed lines indicate model dependencies.

The default display omits library blocks. You could see this same display by opening `model_name` and choosing **Tools > Model Dependencies > Model Dependency Viewer > .mdl File Dependencies Excluding Libraries** from the model menu. Use **View > Dependency Type** to see other dependency displays.

The Model Dependency Viewer is the same tool, and provides the same options, whether you launch it by typing `view_mdhrefs` or by using the Simulink GUI. See “Using the Model Dependency Viewer” for details. To see a demo of the Model Dependency Viewer, type `sldemo_mdhref_depgraph` in the MATLAB Command Window.

**See Also** `find_mdhrefs`



---

<b>Purpose</b>	List contents of signal log
<b>Syntax</b>	<code>log.who</code> <code>tsarray.who</code> <code>log.who('systems')</code> <code>log.who('all')</code>
<b>Description</b>	<p><code>log.who</code> or <code>who(log)</code> lists the names of the top-level signal logging objects (i.e., objects of type <code>Simulink.Timeseries</code>, <code>Simulink.TsArray</code>, <code>Simulink.ModelDataLogs</code>, or <code>Simulink.SubsysDataLogs</code>) contained by <code>log</code> where <code>log</code> is the handle of a <code>Simulink.ModelDataLogs</code> object name.</p> <p><code>tsarray.who</code> or <code>who(tsarray)</code> lists the <code>Simulink.TimeSeries</code> objects contained by the <code>Simulink.TsArray</code> object named <code>tsarray</code>.</p> <p><code>log.who('systems')</code> or <code>who(log, 'systems')</code> lists the names of all signal logging objects contained by <code>log</code> except for <code>Simulink.Timeseries</code> objects stored in <code>Simulink.TsArray</code> objects contained by <code>log</code>.</p> <p><code>log.who('all')</code> or <code>who(log, 'all')</code> lists the names of all signal logging objects contained by <code>log</code></p>
<b>See Also</b>	<code>whos</code> , <code>unpack</code>

# whos

---

**Purpose** List names and types of simulink data logging objects contained by `Simulink.ModelDataLogs` or `Simulink.SubsysDataLogs` object

**Syntax**

```
log.whos
tsarray.whos
log.whos('systems')
log.whos('all')
```

**Description** `log.whos` or `whos(log)` lists the names and types of the top-level signal logging objects (i.e., objects of type `Simulink.TimeSeries`, `Simulink.TsArray`, `Simulink.ModelDataLogs`, or `Simulink.SubsysDataLogs`) contained by `log` where `log` is the handle of a `Simulink.ModelDataLogs` object name.

`tsarray.whos` or `whos(tsarray)` lists the names and types of `Simulink.TimeSeries` objects contained by the `Simulink.TsArray` object named `tsarray`.

`log.who('systems')` or `who(log, 'systems')` lists the names and types of all signal logging objects contained by `log` except for `Simulink.TimeSeries` objects stored in `Simulink.TsArray` objects contained by `log`.

`log.who('all')` or `who(log, 'all')` lists the names and types of all signal logging objects contained by `log`.

**See Also** `who`, `unpack`

# Mask Icon Drawing Commands

---

Command Summary (p. 5-2)

Brief descriptions of commands

Mask Icon Drawing Commands —  
Alphabetical List (p. 5-3)

Icon commands listed in alphabetical  
order

## Command Summary

The following sections describe commands that you can use to draw the icons that represent masked blocks in a block diagram.

<b>Command</b>	<b>Usage</b>
color	Change drawing color of subsequent mask icon drawing commands.
disp	Display text centered on mask icon.
dpoly	Display transfer function on mask icon.
droots	Display zero-pole representation on mask icon.
fprintf	Display variable text on mask icon.
image	Display image on mask icon.
patch	Draw color patch of specified shape on mask icon.
plot	Display graphics on mask icon.
port_label	Display port label on mask icon.
text	Display text at specified location on mask icon.

## **Mask Icon Drawing Commands – Alphabetical List**

# color

---

**Purpose** Change drawing color of subsequent mask icon drawing commands

**Syntax** `color(colorstr)`

**Description** `color(colorstr)` sets the drawing color of all subsequent mask drawing commands to the color specified by the string `colorstr`.

`colorstr` must be one of the following supported color strings.

```
blue
green
red
cyan
magenta
yellow
black
```

Entering any other string or specifying the color using RGB values results in a warning at the MATLAB command prompt and the color change is ignored. The specified drawing color does not influence the color used by the patch or image drawing commands.

## Examples

The following commands

```
color('cyan');
roots([-1], [-2 -3], 4)
color('magenta')
port_label('input',1,'in')
port_label('output',1,'out')
```

draw the following mask icon.

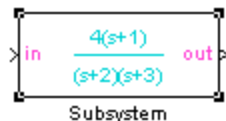

**See Also**      `droots, port_label`

# disp

---

**Purpose** Display text on icon of masked subsystem

**Syntax** `disp(text)`  
`disp(text, 'texmode', 'on')`

**Description** `disp(text)` displays *text* centered on the icon where *text* is any MATLAB expression that evaluates to a string.

`disp(text, 'texmode', 'on')` allows you to use TeX formatting commands in *text*. The TeX formatting commands in turn allow you to include symbols and Greek letters in icon text. See “Mathematical Symbols, Greek Letters, and TEX Characters” in the MATLAB documentation for information on the TeX formatting commands supported by Simulink.

**Examples** The following command

```
disp('{\itEquation:} \alpha^2 + \beta^2 \rightarrow \gamma^2,  
\chi, \phi_3 = {\bfcool}', 'texmode','on')
```

draws the equation that appears on this masked block icon.

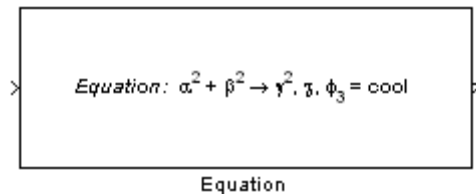

Equation

**See Also** `fprintf`, `port_label`, `text`



**Purpose** Display transfer function or zero-pole representation on icon of masked subsystem

**Syntax**

```
dpoly(num, den)
dpoly(num, den, 'character')

droots(zero, pole, gain)
droots(zero, pole, gain, 'z')
droots(zero, pole, gain, 'z-')
```

**Description** `dpoly(num, den)` displays the transfer function whose numerator is *num* and denominator is *den*.

`dpoly(num, den, 'character')` allows you to specify the name of the transfer function's independent variable. The default is *s*.

`droots(zero, pole, gain)` displays the transfer function whose zero is a *zero*, pole is *pole*, and gain is *gain*.

`droots(zero, pole, gain, 'z')` and `droots(zero, pole, gain, 'z-')` express the equation in terms of *z* or *1/z*.

When the icon is drawn, the initialization commands are executed and the resulting equation is drawn on the icon:

- To display a continuous transfer function in descending powers of *s*, enter

```
dpoly(num, den)
```

For example, for `num = [0 0 1]`; and `den = [1 2 1]` the icon looks like this:

$$\frac{1}{s^2+2s+1}$$

- To display a discrete transfer function in descending powers of *z*, enter

# dpoly, droots

---

```
dpoly(num, den, 'z')
```

For example, for num = [0 0 1]; and den = [1 2 1]; the icon looks like this:

$$\frac{1}{z^2+2z+1}$$

- To display a discrete transfer function in ascending powers of  $1/z$ , enter

```
dpoly(num, den, 'z-')
```

For example, for num and den as defined previously, the icon looks like this:

$$\frac{z^2}{1+2z^{-1}+z^{-2}}$$

- To display a zero-pole gain transfer function, enter

```
droots(z, p, k)
```

For example, the preceding command creates this icon for these values:

```
z = []; p = [-1 -1]; k = 1;
```

$$\frac{1}{(s+1)(s+1)}$$

If the parameters are not defined or have no values when you create the icon, Simulink displays three question marks (? ? ?) in the icon. When the parameter values are entered in the mask dialog box, Simulink evaluates the transfer function and displays the resulting equation in the icon.

**See Also**      `disp, port_label, text`

# fprintf

---

**Purpose** Display variable text centered on icon of masked subsystem

**Syntax** `fprintf(text)`  
`fprintf(format, var)`

**Description** The `fprintf` command displays formatted text centered on the icon and can display *format* along with the contents of *var*.

---

**Note** While this command is identical in name to its corresponding MATLAB function, it provides only the functionality described above.

---

**Examples** This command

```
fprintf('Hello');
```

displays the string 'Hello' on the icon.

This command

```
fprintf('Juhi = %d',17);
```

uses the decimal notation format (%d) to display the variable 17.

**See Also** `disp`, `port_label`, `text`

**Purpose** Display image on icon of masked subsystem

**Syntax**

```
image(a)
image(a, [x, y, w, h])
image(a, [x, y, w, h], rotation)
```

**Description** `image(a)` displays the image `a`, where `a` is an M-by-N-by-3 array of RGB values. You can use the MATLAB commands `imread` and `ind2rgb` to read and convert bitmap files (such as GIF) to the necessary matrix format.

`image(a, [x, y, w, h])` creates the image at the specified position relative to the lower-left corner of the mask.

`image(a, [x, y, w, h], rotation)` allows you to specify whether the image rotates ('on') or remains stationary ('off') as the icon rotates. The default is 'off'.

**Examples** This command

```
image(imread('icon.tif'))
```

reads the icon image from a TIFF file named `icon.tif` in the MATLAB path.

The following commands read and convert a GIF file, `label.gif`, to the appropriate matrix format. You can type these commands in the **Initialization** pane of the Mask Editor.

```
[data, map]=imread('label.gif');
pic=ind2rgb(data,map);
```

Then type the command

```
image(pic)
```

in the **Icon** pane of the Mask Editor to read the converted label image.

# image

---

## **See Also**

patch, plot

**Purpose** Draw color patch of specified shape on icon of masked subsystem

**Syntax** `patch(x, y)`  
`patch(x, y, [r g b])`

**Description** `patch(x, y)` creates a solid patch having the shape specified by the coordinate vectors `x` and `y`. The patch's color is the current foreground color.

`patch(x, y, [r g b])` creates a solid patch of the color specified by the vector `[r g b]`, where `r` is the red component, `g` the green, and `b` the blue. For example,

```
patch([0 .5 1], [0 1 0], [1 0 0])
```

creates a red triangle on the mask's icon.

**Examples** This command

```
patch([0 .5 1], [0 1 0], [1 0 0])
```

creates a red triangle on the mask's icon.



Pyramid

**See Also** `image`, `plot`

# plot

---

## Purpose

Draw graph connecting series of points

## Syntax

```
plot(Y)  
plot(X1,Y1,X2,Y2,...)
```

## Description

`plot(Y)` plots, for a vector  $Y$ , each element against its index. If  $Y$  is a matrix, it plots each column of the matrix as though it were a vector.

`plot(X1,Y1,X2,Y2,...)` plots the vectors  $Y1$  against  $X1$ ,  $Y2$  against  $X2$ , and so on. Vector pairs must be the same length and the list must consist of an even number of vectors.

Plot commands can include NaN and `inf` values. When NaNs or `infs` are encountered, Simulink stops drawing, then begins redrawing at the next numbers that are not NaN or `inf`.

The appearance of the plot on the icon depends on the value of the **Drawing coordinates** parameter. For more information, see “Icon options” in the Using Simulink documentation.

Simulink displays three question marks (? ? ?) in the block icon and issues warnings in these situations:

- When the values for the parameters used in the drawing commands are not yet defined (for example, when the mask is first created and values have not yet been entered in the mask dialog box)
- When a masked block parameter or drawing command is entered incorrectly



**Examples**

This command

```
plot([0 1 5], [0 0 4])
```

generates the plot that appears on the icon for the Ramp block, in the Sources library.



Ramp

**See Also**

image

# port\_label

---

**Purpose** Draw port label on icon of masked subsystem

**Syntax**  
`port_label('port_type', port_number, 'label')`  
`port_label('port_type', port_number, 'label', 'texmode', 'on')`

**Description** `port_label('port_type', port_number, 'label')` draws a label on a port. Valid values for `port_type` include the following:

Value	Description
input	Simulink input port
output	Simulink output port
lconn	Physical Modeling connection port on the left side of a masked subsystem
rconn	Physical Modeling connection port on the right side of a masked subsystem

The input argument `port_number` is an integer, and `label` is a string specifying the port's label.

---

**Note** Physical Modeling port labels are assigned based on the nominal port location. If the masked subsystem has been rotated or flipped, for example, a port labeled using 'lconn' as the `port_type` may not appear on the left side of the block.

---

`port_label('port_type', port_number, 'label', 'texmode', 'on')` lets you use TeX formatting commands in `label`. The TeX formatting commands allow you to include symbols and Greek letters in the port label. See “Mathematical Symbols, Greek Letters, and Tex Characters” in the MATLAB documentation for information on the TeX formatting commands supported by Simulink.

**Examples**

The command

```
port_label('input', 1, 'a')
```

defines a as the label of input port 1.

The commands

```
disp('Card\nSwapper');  
port_label('input',1,'\spadesuit','texmode','on');  
port_label('output',1,'\heartsuit','texmode','on');
```

draw playing card symbols as the labels of the ports on a masked subsystem.

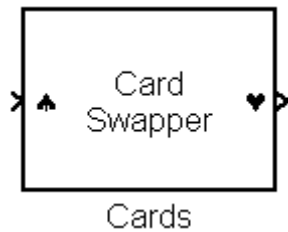
**See Also**

disp, fprintf, text

# text

---

**Purpose** Display text at specific location on icon of masked subsystem

**Syntax**

```
text(x, y, 'text')  
text(x, y, 'text', 'horizontalAlignment', 'halign',  
     'verticalAlignment', 'valign')  
text(x, y, 'text', 'texmode', 'on')
```

**Description** The text command places a character string at a location specified by the point (x,y). The units depend on the **Drawing coordinates** parameter. For more information, see “Icon options”.

`text(x,y, text, 'texmode', 'on')` allows you to use TeX formatting commands in *text*. The TeX formatting commands in turn allow you to include symbols and Greek letters in icon text. See “Mathematical Symbols, Greek Letters, and TEX Characters” in the MATLAB documentation for information on the TeX formatting commands supported by Simulink.

You can optionally specify the horizontal and/or vertical alignment of the text relative to the point (x, y) in the text command.

The text command offers the following horizontal alignment options.

Option	Aligns
'left'	The left end of the text at the specified point
'right'	The right end of the text at the specified point
'center'	The center of the text at the specified point

The text command offers the following vertical alignment options.

Option	Aligns
'base'	The baseline of the text at the specified point
'bottom'	The bottom line of the text at the specified point
'middle'	The midline of the text at the specified point

Option	Aligns
'cap'	The capitals line of the text at the specified point
'top'	The top of the text at the specified point

**Note** While this command is identical in name to its corresponding MATLAB function, it provides only the functionality described above.

## Examples

The command

```
text(0.5, 0.5, 'foobar', 'horizontalAlignment', 'center')
```

centers foobar in the icon.

The command

```
text(.05,.5,'\itEquation:} \Sigma \alpha^2 +
\beta^2 \rightarrow \infty, \Pi, \phi_3 = {\bfcool}',
'hor','left','texmode','on')
```

draws a left-aligned equation on the icon.

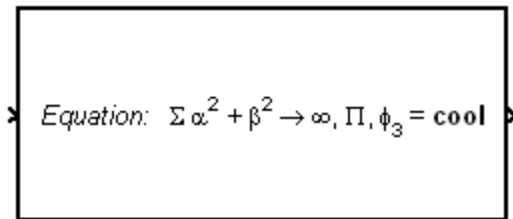

Equation

## See Also

disp, fprintf, port\_label

**text**

---

# Simulink Debugger Commands

---

Command Summary (p. 6-2)

Brief descriptions of commands

Simulink Debugger Commands —  
Alphabetical List (p. 6-5)

Simulink debugger commands listed  
in alphabetical order

## Command Summary

The following table lists the debugger commands. The table's Repeat column specifies whether pressing the **Enter** key at the command line repeats the command. Detailed descriptions of the commands follow the table.

Command	Short Form	Repeat	Description
animate	ani	No	Enable/disable animation mode.
ashow	as	No	Show algebraic loop.
atrace	at	No	Set algebraic loop trace level.
bafter	ba	No	Insert breakpoint after method.
break	b	No	Insert breakpoint before method.
bshow	bs	No	Show specified block.
clear	cl	No	Clear breakpoints from model.
continue	c	Yes	Continue simulation.
disp	d	Yes	Display block's I/O when simulation stops.
ebreak	eb	No	Break at recoverable solver errors.
elist	el	No	Display method execution order.
emode	em	No	Toggle between accelerated and normal mode.
etrace	et	No	Enable or disable method tracing.
help	? or h	No	Display help for debugger commands.



<b>Command</b>	<b>Short Form</b>	<b>Repeat</b>	<b>Description</b>
nanbreak	na	No	Set or clear nonfinite value break mode.
next	n	Yes	Go to start of next time step.
probe	p	No	Display block data.
quit	q	No	Abort simulation.
rbreak	rb	No	Toggle solver reset breakpoint.
run	r	No	Run simulation to completion.
stimes	sti	No	Display model's sample times.
slist	sli	No	Display model's sorted lists.
states	state	No	Display current state values.
status	stat	No	Display debugging options in effect.
step	s	Yes	Advance simulation by one or more methods.
stop	sto	No	Stop simulation.
strace	i	No	Set solver trace level.
systems	sys	No	List model's nonvirtual systems.
tbreak	tb	No	Set or clear time breakpoint.
trace	tr	Yes	Display block's I/O each time block executes.
undisp	und	Yes	Remove block from debugger's list of display points.

<b>Command</b>	<b>Short Form</b>	<b>Repeat</b>	<b>Description</b>
untrace	unt	Yes	Remove block from debugger's list of trace points.
where	w	No	Display current location of simulation in simulation loop.
xbreak	x	No	Break when debugger encounters step-size-limiting state.
zcbreak	zcb	No	Toggle breaking at nonsampled zero-crossing events.
zclist	zcl	No	List blocks containing nonsampled zero crossings.

## **Simulink Debugger Commands – Alphabetical List**

# animate

---

**Purpose** Enable or disable animation mode

**Syntax** `animate [delay | stop]`

**Arguments**

<code>delay</code>	Length in seconds between method calls (1 second by default).
<code><b>stop</b></code>	Disable animation mode.

**Description** `animate` without any arguments enables animation mode. `animate delay` enables animation mode and specifies `delay` as the time delay in seconds between method calls. `animate stop` disables animation mode.

**See Also** `continue`

**Purpose** Show algebraic loop

**Syntax** `ashow <gcb | s:b | s#n | clear>`

**Arguments**

<code>gcb</code>	Current block.
<code>s:b</code>	The block whose system index is <code>s</code> and block index is <code>b</code> .
<code>s#n</code>	The algebraic loop numbered <code>n</code> in system <code>s</code> .
<code>clear</code>	Switch that clears loop coloring.

**Description** `ashow` without any arguments lists all of a model's algebraic loops in the MATLAB Command Window. `ashow gcb` or `ashow s:b` highlights the algebraic loop that contains the specified block. `ashow s#n` highlights the `n`th algebraic loop in system `s`. The `ashow clear` command removes algebraic loop highlights from the model diagram.

**See Also** `atrace`, `slist`

# atrace

---

**Purpose** Set algebraic loop trace level

**Syntax** `atrace level`

**Arguments** `level` Trace level (0 = none, 4 = everything).

**Description** The `atrace` command sets the algebraic loop trace level for a simulation.

<b>Command</b>	<b>Displays for Each Algebraic Loop</b>
<code>atrace 0</code>	No information
<code>atrace 1</code>	The loop variable solution, the number of iterations required to solve the loop, and the estimated solution error
<code>atrace 2</code>	Same as level 1
<code>atrace 3</code>	Level 2 plus Jacobian matrix used to solve loop
<code>atrace 4</code>	Level 3 plus intermediate solutions of the loop variable

**See Also** `states`, `systems`

**Purpose** Insert breakpoint after specified method

**Syntax**

```
bafter
bafter m:mid
bafter <sid:bid | gcb> [meth] [tid:TID]
bafter <s:sid | gcs> [meth] [tid:TID]
bafter mdl [meth] [tid:TID]
```

**Arguments**

<i>mid</i>	Method ID
<i>sid:bid</i>	Block ID
<b>gcb</b>	Currently selected block
<i>sid</i>	System ID
<b>gcs</b>	Currently selected system
<b>mdl</b>	Currently selected model
<i>meth</i>	A method name, e.g., <code>Outputs.Major</code>
TID	Task ID

**Description**

`bafter` inserts a breakpoint after the current method.

`bafter m:mid` inserts a breakpoint after the method specified by *mid* (see “Method ID”).

`bafter sid:bid` inserts a breakpoint after each invocation of the method of the block specified by *sid:bid* (see “Block ID”) in major time steps. `bafter gcb` inserts a breakpoint after each invocation of a method of the currently selected block (see `gcb`) in major times steps.

`bafter s:sid` inserts a breakpoint after each method of the root system or nonvirtual subsystem specified by the system ID: *sid*.

# bafter

---

---

**Note** The `systems` command displays the system IDs for all nonvirtual systems in the currently selected model.

---

`bafter gcs` inserts a breakpoint after each method of the currently selected nonvirtual system.

`bafter mdl` inserts a breakpoint after each method of the currently selected model.

The optional `nth` parameter allow you to set a breakpoint after a particular block, system, or model method and task. For example, `bafter gcb Outputs` sets a breakpoint after the `Outputs` method of the currently selected block.

The optional `TID` parameter allows you to set a breakpoint after invocation of a method by a particular task. For example, suppose that the currently selected nonvirtual subsystem operates on task 2 and 3. Then `bafter gcs Outputs tid:2` sets a breakpoint after the invocation of the subsystem's `Outputs` method that occurs when task 2 is active.

## See Also

`break`, `ebreak`, `tbreak`, `xbreak`, `nanbreak`, `zcbreak`, `rbreak`, `clear`, `where`, `slist`, `systems`



**Purpose** Insert breakpoint before specified method

**Syntax**

```
break
break m:mid
break <sid:bid | gcb> [meth] [tid:TID]
break <s:sid | gcs> [meth] [tid:TID]
break mdl [meth] [tid:TID]
```

**Arguments**

<i>mid</i>	Method ID
<i>sid:bid</i>	Block ID
<b>gcb</b>	Currently selected block
<i>sid</i>	System ID
<i>gcs</i>	Currently selected system
<b>mdl</b>	Currently selected model
<i>meth</i>	A method name, e.g., <code>Outputs.Major</code>
<i>TID</i>	task ID

**Description** `break` inserts a breakpoint before the current method.

`break m:mid` inserts a breakpoint before the method specified by *mid* (see “Method ID”).

`break sid:bid` inserts a breakpoint before each invocation of the method of the block specified by *sid:bid* (see “Block ID”) in major time steps. `break gcb` inserts a breakpoint before each invocation of a method of the currently selected block (see `gcb`) in major times steps.

`break s:sid` inserts a breakpoint at each method of the root system or nonvirtual subsystem specified by the system ID: *sid*.

# break

---

---

**Note** The `systems` command displays the system IDs for all nonvirtual systems in the currently selected model.

---

`break gcs` inserts a breakpoint at each method of the currently selected nonvirtual system.

`break mdl` inserts a breakpoint at each method of the currently selected model.

The optional *meth* parameter allow you to set a breakpoint at a particular block, system, or model method. For example, `break gcb Outputs` sets a breakpoint at the `Outputs` method of the currently selected block.

The optional `TID` parameter allows you to set a breakpoint at the invocation of a method by a particular task. For example, suppose that the currently selected nonvirtual subsystem operates on task 2 and 3. Then `break gcs Outputs tid:2` sets a breakpoint at the invocation of the subsystem's `Outputs` method that occurs when task 2 is active.

## See Also

`bafter`, `clear`, `ebreak`, `nanbreak`, `rbreak`, `systems`, `tbreak`, `where`, `xbreak`, `zcbreak`, `slist`

**Purpose** Show specified block

**Syntax** `bshow s:b`

**Arguments** `s:b` The block whose system index is `s` and block index is `b`.

**Description** The `bshow` command opens the model window containing the specified block and selects the block.

**See Also** `slist`

# clear

---

**Purpose** Clear breakpoints from model

**Syntax**

```
clear  
clear m:mid  
clear id  
clear <sid:bid | gcb>
```

**Arguments**

<i>mid</i>	Method ID
<i>id</i>	Breakpoint ID
<i>sid:bid</i>	Block ID
<b>gcb</b>	Currently selected block

**Description**

`clear` clears a breakpoint from the current method.

`clear m:mid` clears a breakpoint from the method specified by *mid*.

`clear id` clears the breakpoint specified by the breakpoint ID *id*.

`clear sid:bid` clears any breakpoints set on the methods of the block specified by *sid:bid*.

`clear gcb` clears any breakpoints set on the methods of the currently selected block.

**See Also** `break`, `bafter`, `slist`

**Purpose** Continue simulation

**Syntax** `continue`

**Description** The `continue` command continues the simulation from the current breakpoint. If animation mode is not enabled, the simulation continues until it reaches another breakpoint or its final time step. If animation mode is enabled, the simulation continues in animation mode to the first method of the next major time step, ignoring breakpoints.

**See Also** `run`, `stop`, `quit`, `animate`

# disp

---

**Purpose** Display block's I/O when simulation stops

**Syntax**  
disp  
disp **gcb**  
disp s:b

**Arguments**

<b>s:b</b>	The block whose system index is s and block index is b.
<b>gcb</b>	Current block.

**Description** The disp command registers a block as a display point. The debugger displays the inputs and outputs of all display points in the MATLAB Command Window whenever the simulation halts. Invoking disp without arguments shows a list of display points. Use undisp to unregister a block.

**See Also** undisp, slist, probe, trace

<b>Purpose</b>	Enable (or disable) breakpoint on solver errors
<b>Syntax</b>	<code>ebreak</code>
<b>Description</b>	This command causes the simulation to stop if the solver detects a recoverable error in the model. If you do not set or disable this breakpoint, the solver recovers from the error and proceeds with the simulation without notifying you.
<b>See Also</b>	<code>break</code> , <code>bafter</code> , <code>tbreak</code> , <code>xbreak</code> , <code>nanbreak</code> , <code>zcbreak</code> , <code>rbreak</code> , <code>clear</code> , <code>where</code> , <code>slist</code> , <code>systems</code>

## Purpose

List simulation methods in order in which they are executed during simulation

## Syntax

```
elist m:mid [tid:TID]
elist <gcs | s:sid> [mth] [tid:TID]
elist <gcb | sid:bid> [mth] [tid:TID]
```

## Description

elist m:mid lists the methods invoked by the system or nonvirtual subsystem method corresponding to the method id *mid* (see the where command for information on method IDs), e.g.,

```
(sldebug @19): elist m:19

RootSystem.Outputs 'vdp' [tid=0] : ← Calling method
  0:0 Integrator.Outputs 'vdp/x1' [tid=0]
  0:1 Outport.Outputs 'vdp/Out1' [tid=0]
  0:2 Integrator.Outputs 'vdp/x2' [tid=0]
  ...
  ↑           ↑           ↑           ↑
Blockid      Method      Block      Taskid
```

The method list specifies the calling method followed by the methods that it calls in the order in which they are invoked. The entry for the calling method includes

- The name of the method  
The name of the method is prefixed by the type of system that defines the method, e.g., RootSystem.
- The name of the model or subsystem instance on which the method is invoked
- The ID of the task that invokes the method

The entry for each called method includes



- The ID (*sid:bid*) of the block instance on which the method is invoked  
The block ID is prefixed by a number specifying the system that contains the block (the *sid*). This allows Simulink to assign the same block ID to blocks residing in different subsystems.
- The name of the method  
The method name is prefixed with the type of block that defines the method, e.g., Integrator.
- The name of the block instance on which the method is invoked
- The task that invokes the method

The optional task ID parameter (**tid:TID**) allows you to restrict the displayed lists to methods invoked for a specified task. You can specify this option only for system or atomic subsystem methods that invoke Outputs or Update methods.

`elist <gcs | s:sid>` lists the methods executed for the currently selected system (specified by the `gcs` command) or the system or nonvirtual subsystem specified by the system ID *sid*, e.g.,

```
(sldebug @19): elist gcs

RootSystem.Start 'vdp':
  0:0 Integrator.Start 'vdp/x1'
  0:2 Integrator.Start 'vdp/x2'
  0:4 Scope.Start 'vdp/Scope'
  0:5 Fcn.Start 'vdp/Fcn'
  0:6 Product.Start 'vdp/Product'
  0:7 Gain.Start 'vdp/Mu'
  0:8 Sum.Start 'vdp/Sum'

RootSystem.Initialize 'vdp':
  0:0 Integrator.Initialize 'vdp/x1'
  ...
```

The system ID of a model's root system is 0. You can use the debugger's `systems` command to determine the system IDs of a model's subsystems.

---

**Note** The `elist` and `where` commands use block IDs to identify subsystems in their output. The block ID for a subsystem is not the same as the system ID displayed by the `systems` command. Use the `elist sid:bid` form of the `elist` command to display the methods of a subsystem whose block ID appears in the output of a previous invocation of the `elist` or `where` command.

---

`elist <gcs | s:sid> mth` lists methods of type `mth` to be executed for the system specified by the `gcs` command or the system ID `sid`, e.g.,

```
(sldebug @19): elist gcs Start
RootSystem.Start 'vdp':
  0:0 Integrator.Start 'vdp/x1'
  0:2 Integrator.Start 'vdp/x2'
  0:4 Scope.Start 'vdp/Scope'
  0:5 Fcn.Start 'vdp/Fcn'
  0:6 Product.Start 'vdp/Product'
  0:7 Gain.Start 'vdp/Mu'
  0:8 Sum.Start 'vdp/Sum'
  ...
```

Use `elist gcb` to list the methods invoked by the nonvirtual subsystem currently selected in the model.

## See Also

`where`, `slist`, `systems`

<b>Purpose</b>	Toggle model execution between accelerated and normal mode
<b>Syntax</b>	emode
<b>Description</b>	Toggles the simulation between accelerated and normal mode when using the Accelerator mode in Simulink. See “Using the Accelerator Mode with the Simulink Debugger” in “Using Simulink” for more information.

# etrace

---

**Purpose** Enable or disable method tracing

**Syntax** `etrace level level-number`

**Description** This command enables or disables method tracing, depending on the value of `level`:

<b>Level</b>	<b>Description</b>
0	Turn tracing off.
1	Trace model methods.
2	Trace model and system methods.
3	Trace model, system, and block methods.

When method tracing is on, the debugger prints a message at the command line every time a method of the specified level is entered or exited. The message specifies the current simulation time, whether the simulation is entering or exiting the method, the method id and name, and the name of the model, system, or block to which the method belongs.

**See Also** `elist`, `where`, `trace`

**Purpose** Display help for debugger commands

**Syntax** help

**Description** The help command displays a list of debugger commands in the command window. The list includes the syntax and a brief description of each command.

# nanbreak

---

<b>Purpose</b>	Set or clear nonfinite value break mode
<b>Syntax</b>	nanbreak
<b>Description</b>	The nanbreak command causes the debugger to break whenever the simulation encounters a nonfinite (NaN or Inf) value. If nonfinite break mode is set, nanbreak clears it.
<b>See Also</b>	break, bafter, ebreak, rbreak, tbreak, xbreak, zcbreak

**Purpose** Advance simulation to start of next method at current level in model's execution list

**Syntax** next

**Description** The next command advances the simulation to the start of the next method at the current level in the model's method execution list.

---

**Note** The next command has the same effect as the step over command. See step for more information.

---

**See Also** step

# probe

---

**Purpose** Display block data

**Syntax**  
probe  
probe s:b  
probe **gcb**  
probe **level** level-type

**Arguments**

s:b            The block whose system index is s and block index is b.

**gcb**            Currently selected block.

level-type    The type of information displayed [io | all].

**Description** probe causes the debugger to enter an interactive probe mode. In this mode, the debugger displays the I/O of any block you select with a click of a mouse button. To exit probe mode, enter any command or press the **Enter** key.

probe s:b displays the I/O of the block whose index is s:b.

probe gcb displays the I/O of the currently selected block.

probe **level** level-type specifies the type of information displayed, depending on the value of level-type:

Level	Displays
io	Block's I/O
all	All information regarding a block's current state, including inputs and outputs, states, and zero crossings

By default, level-type is set to all.

**See Also** disp, trace



<b>Purpose</b>	Abort simulation
<b>Syntax</b>	quit
<b>Description</b>	The quit command terminates the current simulation.
<b>See Also</b>	stop

# rbreak

---

**Purpose** Break when simulation requires solver reset

**Syntax** `rbreak`

**Description** This command enables (or disables) a solver reset breakpoint if the breakpoint is disabled (or enabled). The breakpoint causes the debugger to halt the simulation whenever an event that requires a solver reset occurs. The halt occurs before the solver is reset.

**See Also** `break`, `bafter`, `ebreak`, `nanbreak`, `tbreak`, `xbreak`, `zcbreak`

**Purpose** Run simulation to completion

**Syntax** run

**Description** The run command runs the simulation from the current breakpoint to its final time step. It ignores breakpoints and display points.

**See Also** continue, stop, quit

**Purpose** Display sorted list of model's root system and of each of its nonvirtual subsystems

**Syntax** `slist`

**Description** The `slist` command displays the sorted list of a model's root system and each of its nonvirtual subsystems. For example, the sorted list for the `vdp` model's root system is

```
---- Sorted list for 'vdp' [9 nonvirtual blocks, directFeed=0]
0:0   'vdp/x1' (Integrator)
0:1   'vdp/Out1' (Outport)
0:2   'vdp/x2' (Integrator)
0:3   'vdp/Out2' (Outport)
0:4   'vdp/Scope' (Scope)
0:5   'vdp/Fcn' (Fcn)
0:6   'vdp/Product' (Product)
0:7   'vdp/Mu' (Gain)
0:8   'vdp/Sum' (Sum)
```

For each system (root or nonvirtual), the `slist` command displays a title line followed by an entry for each block in the order in which the blocks appear in the sorted list. The title line specifies the name of the system, the number of nonvirtual blocks that the system contains, and the number of blocks in the system that have direct feedthrough ports. Each block entry lists the block's id and the name and type of the block. The block id consists of a system index and a block index separated by a colon (s:b). The block index is the position of the block in the sorted list. The system index is the order in which Simulink generated the system's sorted list. The system index has no special significance. It simply allows blocks that appear in the same position in different sorted lists to have unique identifiers.

A sorted list is a list of a root system or nonvirtual subsystem's blocks sorted according to data dependencies and other criteria. Simulink uses sorted lists to create block method execution lists (see `elist`) for root system and nonvirtual subsystem methods that invoke the

corresponding methods of the blocks that the root system or subsystem contains. In general, root system and nonvirtual subsystem methods invoke the block methods in the same order as the blocks appear in the sorted list. However, significant exceptions occur. For example, execution lists for multitask models group all blocks operating at the same rate (i.e., in the same task) together with slower groups appearing later than faster groups. The grouping of methods by task can result in an order of block method execution that differs from the order in which blocks appear in the sorted list. However, within groups, methods execute in the same order as the corresponding blocks appear in the sorted list.

**See Also**

systems, elist

# states

---

**Purpose** Display current state values

**Syntax** `states`

**Description** The `states` command displays a list of the current states of the model. The display lists the index, current value, `system:block:element ID`, state vector name, and block name for each state.

**Example** The following command displays information about the states for the `hardstop` demo:

```
(sdebug @41): >> states
```

```
Continuous States:
```

```
Idx Value (system:block:element Name 'BlockName')
  0 -0.5 (0:1:0 CSTATE 'hardstop/position')
  1 100 (0:9:0 CSTATE 'hardstop/velocity')
```

<b>Purpose</b>	Display debugging options in effect
<b>Syntax</b>	status
<b>Description</b>	The status command displays a list of the debugging options in effect.

# step

**Purpose** Advance simulation by one or more methods

**Syntax**

```
step [in into]
step over
step out
step top
step blockmth
```

**Description** This command advances the simulation

- Into (step [in into]), over (step over), or out of the method at which the simulation is currently stopped (step out)
- To the top of the simulation loop (step top), i.e., to the start of the first method executed at the start of the next time step
- To the next method that operates on a block (step blockmth)

The following diagram illustrates the effect of various forms of the step command.

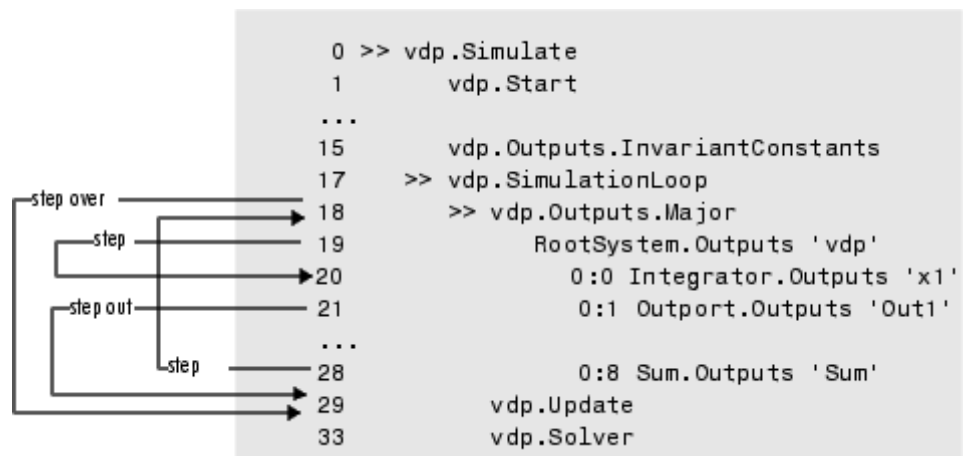



If this command advances the simulation to the start of a block method, the debugger points the debug pointer at the block on which the method operates.

**See Also**

next, where, elist

# stimes

---

**Purpose** Display sample times defined by model being debugged

**Syntax** `stimes`

**Description** This command displays information about the sample times defined by this model, including the sample time's period, offset, and task ID.

**Example** The following command displays the sample times for the f14 demo:

```
(sldebug @0): >> stimes

--- Sample times for 'f14' [Number of sample times = 3]
  1. [0      , 0      ] tid=0 (continuous sample time)
  2. [0      , 1      ] tid=1 (continuous but fixed in minor step)
  3. [0.1    , 0      ] tid=2
```

<b>Purpose</b>	Stop simulation
<b>Syntax</b>	stop
<b>Description</b>	The stop command stops the simulation.
<b>See Also</b>	continue, run, quit

# strace

---

**Purpose** Set solver trace level

**Syntax** strace level

**Arguments** level Trace level (0 = none, 1 = everything).

**Description** The strace command causes the solver to display diagnostic information in the MATLAB Command Window, depending on the value of level. Valid values are 0 (no information) or 1 (maximum detail).

Command	Displays
strace 0	No information
strace 1	Information about time steps, integration steps, zero crossings, and solver resets

When diagnostic tracing is on, the debugger displays the sizes of major and minor time steps:

```
[TM = 13.21072088374186 ] Start of Major Time Step  
[Tm = 13.21072088374186 ] Start of Minor Time Step
```

The debugger also displays integration information, including the time step of the integration method, the step size of the integration method, the outcome of the integration step, the normalized error, and the index of the state:

```
[Tm = 13.21072088374186 ] [H = 0.2751116230148764 ] Begin Integration Step  
[Tf = 13.48583250675674 ] [Hf = 0.2751116230148764 ] Fail [Er = 1.0404e+000]  
[Ix = 1]  
[Tm = 13.21072088374186 ] [H = 0.2183536061326544 ] Retry  
[Ts = 13.42907448987452 ] [Hs = 0.2183536061326539 ] Pass [Er = 2.8856e-001]  
[Ix = 1]
```

When a zero crossing is detected, the debugger displays information about the iterative search algorithm used to identify when the zero crossing occurred. This includes the time step of the zero crossing, the step size of the zero crossing detection algorithm, the length of the time interval bracketing the zero crossing, and a flag denoting the rising or falling direction of the zero crossing:

```
[Tz = 3.615333333333301 ] Detected 1 Zero Crossing Event 0[F]
      Begin iterative search to bracket zero crossing event
[Tz = 3.621111157580072 ] [Hz = 0.005777824246771424 ] [Iz = 4.2222e-003] 0[F]
[Tz = 3.621116982080098 ] [Hz = 0.005783648746797265 ] [Iz = 4.2164e-003] 0[F]
[Tz = 3.621116987943544 ] [Hz = 0.005783654610242994 ] [Iz = 4.2163e-003] 0[F]
[Tz = 3.621116987943544 ] [Hz = 0.005783654610242994 ] [Iz = 1.1804e-011] 0[F]
[Tz = 3.621116987949452 ] [Hz = 0.005783654616151157 ] [Iz = 5.8962e-012] 0[F]
[Tz = 3.621116987949452 ] [Hz = 0.005783654616151157 ] [Iz = 5.1514e-014] 0[F]
      End iterative search to bracket zero crossing event
```

When solver resets occur, the debugger displays the time at which the solver was reset:

```
[Tr = 6.246905153573676 ] Process Solver Reset
[Tr = 6.246905153573676 ] Reset Zero Crossing Cache
[Tr = 6.246905153573676 ] Reset Derivative Cache
```

For more information about the notation displayed by strace, type the following command at the sldebug prompt:

```
help time
```

## See Also

atrace, etrace, states, trace, zclist

# systems

---

<b>Purpose</b>	List model's nonvirtual systems
<b>Syntax</b>	systems
<b>Description</b>	The systems command lists a model's nonvirtual systems in the MATLAB Command Window.
<b>See Also</b>	slist

**Purpose** Set or clear time breakpoint

**Syntax** tbreak  
tbreak t

**Description** The tbreak command sets a breakpoint at the specified time step. If a breakpoint already exists at the specified time, tbreak clears the breakpoint. If you do not specify a time, tbreak toggles a breakpoint at the current time step.

**See Also** break, bafter, ebreak, xbreak, nanbreak, zcbreak, rbreak

# trace

---

**Purpose**            Display block's I/O each time block executes

**Syntax**            `trace gcb`  
                      `trace s:b`

**Arguments**        `s:b`            The block whose system index is s and block index is b.  
                      `gcb`            Current block.

**Description**        The trace command registers a block as a trace point. The debugger displays the I/O of each registered block each time the block executes.

**See Also**            `disp`, `probe`, `untrace`, `slist`, `strace`



**Purpose** Remove block from debugger's list of display points

**Syntax** undisp gcb  
undisp s:b

**Arguments** s:b The block whose system index is s and block index is b.  
gcb Current block.

**Description** The undisp command removes the specified block from the debugger's list of display points.

**See Also** disp, slist

# untrace

---

**Purpose** Remove block from debugger's list of trace points

**Syntax** untrace gcb  
untrace s:b

**Arguments** s:b The block whose system index is s and block index is b.  
gcb Current block.

**Description** The untrace command removes the specified block from the debugger's list of trace points.

**See Also** trace, slist

**Purpose** Display current location of simulation in simulation loop

**Syntax** `where [detail]`

**Description** The where command displays the current location of the simulation in the simulation loop, for example,

```
sldebug @7): where
  0 >> vdp.Simulate
  1   >> vdp.Start
  2     >> RootSystem.Start 'vdp'
  7       >| 0:8 Sum.Start 'Sum'
```

Method ID    State    Block ID    Method    Block

The display consists of a list of simulation nodes with the last entry being the node that is about to be entered or exited. Each entry contains the following information:

- Method ID
  - The method ID identifies a specific invocation of a method.
- A symbol specifying its state:
  - >> (active)
  - >|(about to be entered)
  - <|(about to be exited)
- Name of the method invoked (e.g., RootSystem.Start)
- Name of the block or system on which the method is invoked (e.g., Sum)
- System and block ID (sid:bid) of the block on which the method is invoked

# where

---

For example, 0:8 indicates that the specified method operates on block 8 of system 0.

where detail, where detail is any nonnegative integer, includes inactive nodes in the display.

```
0 >> vdp.Simulate
  1   >> vdp.Start
  2     >> RootSystem.Start 'vdp'
  3       0:4 Scope.Start 'Scope'
  4         0:5 Fcn.Start 'Fcn'
  5           0:6 Product.Start
'Product'
  6             0:7 Gain.Start 'Mu'
  7               >| 0:8 Sum.Start 'Sum'
```

## See Also

step

<b>Purpose</b>	Break when debugger encounters step-size-limiting state
<b>Syntax</b>	<code>xbreak</code>
<b>Description</b>	The <code>xbreak</code> command pauses execution of the model when the debugger encounters a state that limits the size of the steps that the solver takes. If <code>xbreak</code> mode is already on, <code>xbreak</code> turns the mode off.
<b>See Also</b>	<code>break</code> , <code>bafter</code> , <code>ebreak</code> , <code>zcbreak</code> , <code>tbreak</code> , <code>nanbreak</code> , <code>rbreak</code>

# zcbreak

---

<b>Purpose</b>	Toggle breaking at nonsampled zero-crossing events
<b>Syntax</b>	zcbreak
<b>Description</b>	The zcbreak command causes the debugger to break when a nonsampled zero-crossing event occurs. If zero-crossing break mode is already on, zcbreak turns the mode off.
<b>See Also</b>	break, bafter, xbreak, tbreak, nanbreak, zclist

<b>Purpose</b>	List blocks containing nonsampled zero crossings
<b>Syntax</b>	<code>zclist</code>
<b>Description</b>	The <code>zclist</code> command displays a list of blocks in which nonsampled zero crossings can occur. The command displays the list in the MATLAB Command Window.
<b>See Also</b>	<code>zcbreak</code>





# Data Object Classes

---

Class Summary (p. 7-2)

Brief description of data object classes

Classes — Alphabetical List (p. 7-4)

Data object classes listed in alphabetical order

## Class Summary

The following table briefly describes the purpose of each Simulink data object class. See “Working with Data Objects” in *Using Simulink* for general information on creating and using Simulink data objects.

Class	Purpose
EventData	Provide information about block method execution events.
Simulink.AliasType	Specify alternate name for existing data type.
Simulink.Annotation	Specify properties of model annotation
Simulink.BlockComp-DworkData	Provide post-compilation information about block’s Dwork vector.
Simulink.BlockCompInput-PortData	Provide post-compilation information about block input port.
Simulink.BlockCompOutput-PortData	Provide post-compilation information about block output port.
Simulink.BlockData	Provide run-time information about block-related data, such as block parameters.
Simulink.BlockPortData	Describe block input or output port.
Simulink.BlockPreComp-InputPortData	Provide precompilation information about block input port.
Simulink.BlockPreComp-OutputPortData	Provide precompilation information about block output port.
Simulink.Bus	Describe signal bus.
Simulink.BusElement	Describe element of signal bus.
Simulink.ConfigSet	Access model configuration set.
Simulink.ConfigSetRef	Link a model to a configuration set that is stored independently of any model
Simulink.ModelAdvisor	Run the Model Advisor programmatically.
Simulink.ModelDataLogs	Store model’s signal logs.

<b>Class</b>	<b>Purpose</b>
<code>Simulink.ModelWorkspace</code>	Access model's workspace.
<code>Simulink.MSFcnRunTime-Block</code>	Get run-time information about Level-2 M-file S-function block.
<code>Simulink.NumericType</code>	Describe numeric data type.
<code>Simulink.Parameter</code>	Describe value of block parameter.
<code>Simulink.ParamRTWInfo</code>	Specify information needed to generate code for parameter.
<code>Simulink.RunTimeBlock</code>	Allow Level-2 M-file S-function and other M-file programs to get information about block while simulation is running.
<code>Simulink.ScopeDataLogs</code>	Log data displayed by Scope viewer.
<code>Simulink.Signal</code>	Describes value of block output.
<code>Simulink.StructElement</code>	Describe element of data structure.
<code>Simulink.StructType</code>	Describe data structure.
<code>Simulink.SubsysDataLogs</code>	Store subsystem's signal logs.
<code>Simulink.TimeInfo</code>	Provide information about time data in <code>Simulink.Timeseries</code> object.
<code>Simulink.Timeseries</code>	Log for elementary signal.
<code>Simulink.TsArray</code>	Log for composite signal.

## **Classes – Alphabetical List**

**Purpose** Provide information about block method execution events

**Description** Simulink creates an instance of this class when a block method execution event occurs during simulation and passes it to any listeners registered for the event (see `add_exec_event_listener`). The instance specifies the type of event that occurred and the block whose method execution triggered the event. See “Accessing Block Data During Simulation” in *Using Simulink* for more information.

**Parent** None

**Children** None

## Property Summary

Name	Description
“Type”	Type of method execution event that occurred.
“Source”	Block that triggered the event.

## Properties

Type

### Description

Type of method execution event that occurred. Possible values are:

Event	Occurs...
'PreOutputs'	Before a block's Outputs method executes.
'PostOutputs'	After a block's Outputs method executes.
'PreUpdate'	Before a block's Update method executes.
'PostUpdate'	After a block's Update method executes.
'PreDerivatives'	Before a block's Derivatives method executes.
'PostDerivatives'	After a block's Derivatives method executes.

### Data Type

string

# EventData

---

## **Access**

RO

---

Source

## **Description**

Block that triggered the event

## **Data Type**

Simulink.RunTimeBlock

## **Access**

RO

**Purpose**

Create alias for signal and/or parameter data type

**Description**

This class allows you to designate MATLAB variables as aliases for signal and parameter data types. You do this by creating instances of this class and assigning them to variables in the MATLAB or model workspaces (see “Creating a Data Type Alias” on page 7-7). The MATLAB variable to which a `Simulink.AliasType` object is assigned is called a data type alias. The data type to which an alias refers is called its base type. Simulink allows you to set the `BaseType` property of the object that the variable references, thereby designating the data type for which it is an alias.

Simulink lets you use aliases instead of actual type names in dialog boxes and `set_param` commands to specify the data types of Simulink block outputs and parameters. Using aliases to specify signal and parameter data types can greatly simplify global changes to the signal and parameter data types that a model specifies. In particular, changing the data type of all signals and parameters whose data type is specified by an alias requires only changing the base type of the alias. By contrast, changing the data types of signals and parameters whose data types are specified by an actual type name requires respecifying the data type of each signal and parameter individually.

---

**Note** Suppose you specify an instance of the `Simulink.AliasType` class as the value of a `Simulink.Parameter` object’s **Data type** property. If you enter the parameter object in a subsystem’s mask, the subsystem displays the data type’s base type instead of its alias name.

---

**Creating a Data Type Alias**

You can use either the Model Explorer or MATLAB commands (see “MATLAB Commands for Creating Data Type Aliases” on page 7-8) to create a data type alias.

To use the Model Explorer to create an alias:

# Simulink.AliasType

---

- 1 Select Base Workspace (i.e., the MATLAB workspace) in the Model Explorer's **Model Hierarchy** pane.

You must create data type aliases in the MATLAB workspace. If you attempt to create an alias in a model workspace, Simulink displays an error.

- 2 Select **Simulink.AliasType** from the Model Explorer's **Add** menu.

Simulink creates an instance of a `Simulink.AliasType` object and assigns it to a variable named `Alias` in the MATLAB workspace.

- 3 Rename the variable to a more appropriate name, for example, a name that reflects its intended usage.

To change the name, edit the name displayed in the **Name** field in the Model Explorer's **Contents** pane.

- 4 Enter the name of the data type that this alias represents in the **Base type** field in the Model Explorer's **Dialog** pane.

You can specify the name of any existing standard or user-defined data type in this field. Skip this step if the desired base type is `double` (the default).

- 5 Use the MATLAB save command to save the newly created alias in a MAT-file that can be loaded by the models in which it is used.

## **MATLAB Commands for Creating Data Type Aliases**

Use the following syntax to create a data type alias at the MATLAB command line or in a MATLAB program

```
ALIAS = Simulink.AliasType;
```

where `ALIAS` is the name of the variable that you want to serve as the alias. For example, the following line creates an alias names `MyFloat`.

```
MyFloat = Simulink.AliasType;
```



The following notations get and set the properties of a data type alias, respectively,

```
PROPVALUE = ALIAS.PROPNAME;  
ALIAS.PROPNAME = PROPVALUE;
```

where ALIAS is the name of the alias, PROPNAME is the name of the alias object's properties, and PROPVALUE is the property's value. For example, the following code saves the current value of MyFloat's BaseType property and assigns it a new value.

```
old = MyFloat.BaseType;  
MyFloat.BaseType = 'single';
```

See “Properties” on page 7-11 for information on the names, permitted values, and usage of the properties of data type alias objects.

## Data Type Aliases in the Generated Code

You can cause data type aliases to appear in the code generated for a model using any of the following methods.

- Specifying the signal data type of a block in the model as a Simulink.AliasType via the **Block Parameters** dialog box.
- Creating a Simulink.Signal object that uses the Simulink.AliasType as its data type. Use this signal object as the name of a signal in the model and specify that the signal name must resolve to an object in the MATLAB workspace. See “Signal Objects” in the Real-Time Workshop User's Guide for more information.
- Creating a Simulink.Parameter object that uses the Simulink.AliasType as its data type. Use this parameter object as a block parameter in the model. See “Generated Code for Parameter Data Types” in the Real-Time Workshop User's Guide for more information.

# Simulink.AliasType

---

---

**Note** If a data type is assigned both in a block's **Block Parameters** dialog box and using a `Simulink.Signal` object on the signal feeding into the block, the code is always generated using the data type in the dialog box.

---

**Parent** None

**Children** None.

**Property  
Dialog  
Box**

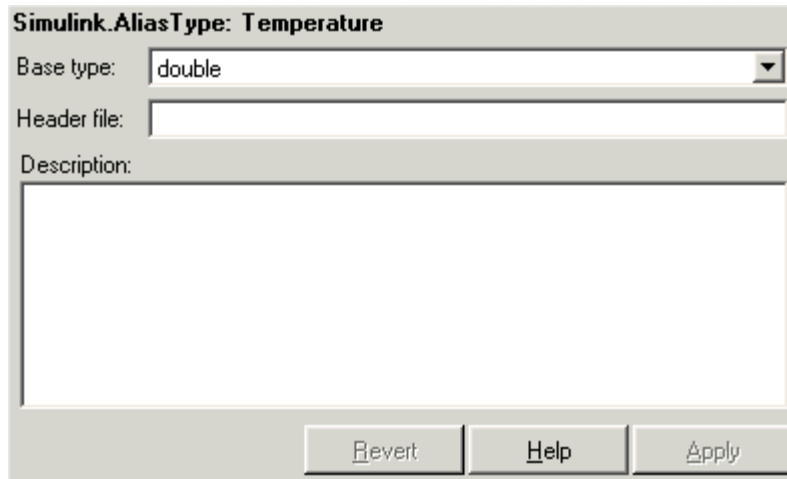

The screenshot shows a dialog box titled "Simulink.AliasType: Temperature". It has three main sections: "Base type:" with a pull-down menu currently set to "double"; "Header file:" with an empty text input field; and "Description:" with a large, empty text area. At the bottom of the dialog are three buttons: "Revert", "Help", and "Apply".

**Base type**

The data type to which this alias refers. The default is `double`. To specify another data type, select the data type from the adjacent pull-down list of standard data types or enter the data type's name in the edit field. Note that you can, with one exception, specify a nonstandard data type, e.g., a data type defined by a `Simulink.NumericType` object, by entering the data type's name in the edit field. The exception is a `Simulink.NumericType` whose `Category` is `Fixed-point: unspecified scaling`.

---

**Note** Fixed-point: unspecified scaling is a partially specified type whose definition is completed by the block that uses the `Simulink.NumericType`. Forbidding its use in alias types avoids creating aliases that have different base types depending on where they are used.

---

## Header file

Name of a user-supplied C header file that defines a data type having the same name as this alias (i.e., as the MATLAB variable that references this alias object). If this field is not empty, code generated from this model defines the alias type by including the specified header file. If this field is empty, the generated code defines the alias type itself.

## Description

Describes the usage of the data type referenced by this alias.

## Properties

Name	Description
BaseType	A string specifying the name of a standard or custom data type. ( <b>Base Type</b> )
Description	A string that describes the usage of the data type. May be a null string. ( <b>Description</b> )
HeaderFile	A string that specifies the name of a C header file that defines a data type having the same name as the alias. ( <b>Header File</b> )

# Simulink.Annotation

---

**Purpose** Specify properties of model annotation

**Description** Instances of this class specify the properties of annotations. You can use `getCallbackAnnotation` in an annotation callback function to get the `Simulink.Annotation` instance for the annotation associated with the callback function. You can use `find_system` and `get_param` to get the `Simulink.Annotation` instance associated with any annotation in a model. For example, the following code gets the annotation object for the first annotation in the currently selected model and turns on its drop shadow

```
ah = find_system(gcs, 'FindAll', 'on', 'type', 'annotation');  
ao = get_param(ah(1), 'Object');  
ao.DropShadow = 'on';
```

**Children** None.

## Property Summary

Property	Description	Values
Text	String specifying text of annotation. Same as Name.	string
ClickFcn	Specifies MATLAB code to be executed when a user single-clicks this annotation. Simulink stores the code entered in this field with the model. See “Associating Click Functions with Annotations” for more information.	string
Description	String that describes this annotation.	string

Property	Description	Values
FontAngle	String specifying the angle of the annotation's font. The default value, 'auto', specifies use of the model's preferred font angle.	'normal'   'italic'   'oblique'   {'auto'}
FontName	String specifying name of annotation's font. The default value, 'auto', specifies use of the model's preferred font.	string
FontSize	Integer specifying size of annotation's font in points. The default value, -1, specifies use of the model's preferred font size.	real {'-1'}
FontWeight	String specifying the weight of the annotation's font. The default value, 'auto', specifies use of the model's preferred font weight.	'light'   'normal'   'demi'   'bold'   {'auto'}
Handle	Annotation handle.	real
HiliteAncestors	For internal use.	
Name	String specifying text of annotation. Same as Text.	string
Selected	String specifying whether this annotation is currently selected ('on') or not selected ('off').	{'on'}   'off'
Parent	String specifying parent name of annotation object.	string
Path	Path to the annotation.	string

# Simulink.Annotation

Property	Description	Values
Position	Two-element vector specifying the x-y coordinates of this annotation relative to the top, left corner of the block diagram, e.g., [236 83].	vector [left top right bottom] not enclosed in quotation marks. The maximum value for a coordinate is 32767.
Horizontal-Alignment	String specifying the horizontal alignment of this annotation, e.g., 'center'.	{'center'}   'left'   'right'
VerticalAlignment	String specifying the vertical alignment of this annotation, e.g., 'middle'.	{'middle'}   'top'   'cap'   'baseline'   'bottom'
ForegroundColor	String specifying foreground color of this annotation.	RGB value array string   [r,g,b,a] where r, g, b, and a are the red, green, blue, and alpha values of the color normalized to the range 0.0 to 1.0, delineated with commas. The alpha value is optional and ignored.  Block background color can also be 'black', 'white', 'red', 'green', 'blue', 'cyan', 'magenta', 'yellow', 'gray', 'lightBlue', 'orange', 'darkGreen'.

Property	Description	Values
BackgroundColor	String specifying background color of this annotation.	<p>RGB value array string   [r,g,b,a] where r, g, b, and a are the red, green, blue, and alpha values of the color normalized to the range 0.0 to 1.0, delineated with commas. The alpha value is optional and ignored.</p> <p>Block background color can also be 'black', 'white', 'red', 'green', 'blue', 'cyan', 'magenta', 'yellow', 'gray', 'lightBlue', 'orange', 'darkGreen'.</p>
DropShadow	String specifying whether to display a drop shadow. Options are 'on' or 'off'.	'on'   {'off'}
TeXMode	String specifying whether to render TeX markup. Options are 'on' or 'off'.	'on'   {'off'}
Type	Annotation type. This is always 'annotation'	string
LoadFcn	String specifying M-code to be executed when the model containing this annotation is loaded. See “Annotation Callback Functions” in the online Simulink documentation.	string

# Simulink.Annotation

Property	Description	Values
DeleteFcn	String specifying M-code to be executed before deleting this annotation. See “Annotation Callback Functions” in the online Simulink documentation.	string
RequirementInfo	For internal use.	string
Tag	User-specified text that is assigned to the annotation’s Tag parameter and saved with the annotation.	string
UseDisplayText-AsClickCallback	<p>String specifying whether to use the contents of the Text property as this annotation’s click function. Options are 'on' or 'off'.</p> <p>If set to 'on', the text of the annotation is interpreted as a valid MATLAB expression and run. If set to 'off', clicking on the annotation runs the click function, if there is one. If there is no click function, clicking the annotation has no effect.</p> <p>See “Associating Click Functions with Annotations” in the Using Simulink documentation for more information.</p>	'on'   {'off'}
UserData	Any data that you want to associate with this annotation.	vector



**Purpose** Provide postcompilation information about block's Dwork vector

**Description** Simulink returns an instance of this class when an M-file program, e.g., a Level-2 M-file S-function, invokes the “Dwork” on page 7-126 method of a block's run-time object after the model containing the block has been compiled.

**Parent** Simulink.BlockData

**Children** None

## Property Summary

Name	Description
“Usage” on page 7-17	Usage type of this Dwork vector.
“UsedAsDiscState”	True if this Dwork vector is being used to store the values of a block's discrete states.

## Properties

---

Usage

### Description

Returns a string indicating how this Dwork vector is used. Permissible values are:

- DWork
- DState
- Scratch
- Mode

### Data Type

string

### Access

RW for M-file S-function blocks, RO for other blocks.

# Simulink.BlockCompDworkData

---

---

UsedAsDiscState

**Description**

True if this Dwork vector is being used to store the values of a block's discrete states.

**Data Type**

Boolean

**Access**

RW for M-file S-function blocks, RO for other blocks.

**Purpose** Provide postcompilation information about block input port

**Description** Simulink returns an instance of this class when an M-file program, e.g., a Level-2 M-file S-function, invokes the “InputPort” on page 7-127 method of a block’s run-time object after the model containing the block has been compiled.

**Parent** Simulink.BlockPortData

**Children** None

## Property Summary

Name	Description
“DirectFeedthrough”	True if this port has direct feedthrough.
“Overwritable”	True if this port is overwritable.

## Properties

---

DirectFeedthrough

### Description

True if this input port has direct feedthrough.

### Data Type

Boolean

### Access

RW for M-file S functions, RO for other blocks.

---

Overwritable

### Description

True if this input port is overwritable.

### Data Type

Boolean

### Access

RW for M-file S functions, RO for other blocks.

# Simulink.BlockCompOutputPortData

---

**Purpose** Provide postcompilation information about block output port

**Description** Simulink returns an instance of this class when an M-file program, e.g., a Level-2 M-file S-function, invokes the “OutputPort” on page 7-128 method of a block’s run-time object after the model containing the block has been compiled.

**Parent** Simulink.BlockPortData

**Children** None

## Property Summary

Name	Description
“Reusable”	Specifies whether an output port’s memory is reusable.

## Properties

---

Reusable

### Description

Specifies whether an output port’s memory is reusable. Options are: NotReusableAndGlobal and ReusableAndLocal.

### Data Type

string

### Access

RW for M-file S functions, RO for other blocks.

**Purpose** Provide run-time information about block-related data, such as block parameters

**Description** This class defines properties that are common to objects that provide run-time information about a block's ports and work vectors.

**Parent** None

**Children** Simulink.BlockPortData, Simulink.BlockCompDworkData

## Property Summary

Name	Description
"AliasedThroughDataType"	Fundamental base data type.
"AliasedThroughDataType-ID"	Fundamental base data type ID.
"Complexity"	Numeric type (real or complex) of the block data.
"Data"	The block data.
"DataAsDouble"	The block data in double form.
"Datatype"	Data type of the block data.
"DatatypeID"	Index of the data type of the block data.
"Dimensions"	Dimensions of the block data.
"Name"	Name of the block data.
"Type"	Type of block data (e.g., a parameter).

## Properties

AliasedThroughDataType

### Description

Data type aliases allow a data type (B) to be recursively aliased to another alias type or BaseType (A). If alias type A is aliased to another

# Simulink.BlockData

---

alias type that is aliased to another alias type and so forth, this property allows the alias type to be iteratively searched (aliased through) until the type is no longer an alias type and that final result is the value of the property returned. For example, assume that you have created the Simulink Alias types A and B as follows:

```
A=Simulink.AliasType('double')

A =
Simulink.AliasType
  Description: ''
  HeaderFile: ''
  BaseType: 'double'
B=Simulink.AliasType('A')

B =
Simulink.AliasType
  Description: ''
  HeaderFile: ''
  BaseType: 'A'
```

If the data type of an item of block data is B, this property returns the base type A instead of B.

## **Data Type**

string

## **Access**

RO

---

AliasedThroughDataTypeID

## **Description**

Index of the data type alias returned by the AliasedThroughDataType property.

## **Data Type**

integer

**Access**

RO

---

Complexity

**Description**

Numeric type (real or complex) of the block data.

**Data Type**

string

**Access**

RW for M-file S functions, RO for other blocks.

---

Data

**Description**

The block data.

**Data Type**

The data type specified by the “Datatype” or “DatatypeID” properties of this object.

**Access**

RW

---

DataAsDouble

**Description**

The block data’s in double form.

**Data Type**

double

**Access**

RO

---

Datatype

**Description**

Data type of the values of the block-related object.

# Simulink.BlockData

---

**Data Type**

string

**Access**

RO

---

DatatypeID

**Description**

Index of the data type of the values of the block-related object. Enter the numeric value for the desired data type, as follows:

Data Type	Value
'inherited'	-1
'double'	0
'single'	1
'int8'	2
'uint8'	3
'int16'	4
'uint16'	5
'int32'	6
'uint32'	7
'boolean' or fixed-point data types	8

---

**Data Type**

integer

**Access**

RW for M-file S functions, RO for other blocks

---

Dimensions

**Description**

Dimensions of the block-related object, e.g., parameter or DWork vector.



**Data Type**

array

**Access**

RW for M-file S functions, RO for other blocks

---

Name

**Description**

Name of block-related object, e.g., a block parameter or Dwork vector.

**Data Type**

string

**Access**

RW for M-file S functions, RO for other blocks

---

Type

**Description**

Type of block data. Possible values are:

Type	Description
'BlockPreCompInputPortData '	This object contains data for an input port before the model is compiled.
'BlockPreCompOutputPortData '	This object contains data for an output port before the model is compiled.
'BlockCompInputPortData '	This object contains data for an input port after the model is compiled.
'BlockCompOutputPortData '	This object contains data for an output port after the model is compiled.

# Simulink.BlockData

---

Type	Description
'BlockPreCompDworkData '	This object contains data for a Dwork vector before the model is compiled.
'BlockCompDworkData '	This object contains data for a Dwork vector after the model is compiled.
'BlockDialogPrmData '	This object describes a dialog box parameter of a Level-2 M-file S-function.
'BlockRuntimePrmData '	This object describes a run-time parameter of a Level-2 M-file S-function.
'BlockCompContStatesData '	This object describes the continuous states of the block at the current time step.
'BlockDerivativesData '	This object describes the derivatives of the block's continuous states at the current time step.

**Data Type**

string

**Access**

RO

**Purpose** Describe block input or output port

**Description** This class defines properties that are common to objects that provide run-time information about a block's ports.

**Parent** Simulink.BlockData

**Children** Simulink.BlockPreCompInputPortData, Simulink.BlockPreCompOutputPortData, Simulink.BlockCompInputPortData, Simulink.BlockCompOutputPortData

## Property Summary

Name	Description
"IsBus"	True if this port is connected to a bus.
"IsSampleHit"	True if this port produces output or accepts input at the current simulation time step.
"SampleTime"	Sample time of this port.
"SampleTimeIndex"	Sample time index of this port.
"SamplingMode"	Sampling mode of the port.

## Properties

---

IsBus

### Description

True if this port is connected to a bus.

### Data Type

Boolean

### Access

RO

# Simulink.BlockPortData

---

---

IsSampleHit

**Description**

True if this port produces output or accepts input at the current simulation time step.

**Data Type**

Boolean

**Access**

RO

---

SampleTime

**Description**

Sample time of this port.

**Data Type**

[period offset] where period and offset are values of type double. See “Specifying Sample Time” for more information.

**Access**

RW for M-file S functions, RO for other blocks

---

SampleTimeIndex

**Description**

Sample time index of this port.

**Data Type**

integer

**Access**

RO

---

SamplingMode

**Description**

Sampling mode of the port. Valid values are:

Value	Description
'frame'	Port accepts or outputs frame-based signals. The use of frame-based signals requires a Signal Processing Blockset license.
'inherited'	Sampling mode is inherited from the port to which this port is connected.
'sample'	Port accepts or outputs sampled data.

**Data Type**

string

**Access**

RW for M-file S functions, RO for other blocks

# Simulink.BlockPreCompInputPortData

---

**Purpose** Provide precompilation information about block input port

**Description** Simulink returns an instance of this class when an M-file program, e.g., a Level-2 M-file S-function, invokes the “InputPort” on page 7-127 method of a block’s run-time object before the model containing the block has been compiled.

**Parent** Simulink.BlockPortData

**Children** None

## Property Summary

Name	Description
“DirectFeedthrough”	True if this port has direct feedthrough.
“Overwritable”	True if this port is overwritable.

## Properties

---

DirectFeedthrough

### Description

True if this input port has direct feedthrough.

### Data Type

Boolean

### Access

RW for M-file S functions, RO for other blocks

---

Overwritable

### Description

True if this input port is overwritable.

### Data Type

Boolean

### Access

RW for M-file S functions, RO for other blocks

**Purpose** Provide precompilation information about block output port

**Description** Simulink returns an instance of this class when an M-file program, e.g., a Level-2 M-file S-function, invokes the “OutputPort” on page 7-128 method of a block’s run-time object before the model containing the block has been compiled.

**Parent** Simulink.BlockPortData

**Children** none

## Property Summary

Name	Description
“Reusable”	Specifies whether an output port’s memory is reusable.

## Properties

---

Reusable

### Description

Specifies whether an output port’s memory is reusable. Options are: NotReusableAndGlobal and ReusableAndLocal.

### Data Type

string

### Access

RW for M-file S functions, RO for other blocks

# Simulink.Bus

---

**Purpose** Specify properties of signal bus

**Description** Objects of this class (in conjunction with objects of the `Simulink.BusElement` class) specify the properties of a signal bus. You can use these objects to enable Simulink to check the validity of buses connected to the inputs of blocks in your model. You do this by entering the name of a bus object defining a bus in the **Bus object** field of a block's parameter dialog box. When you update the model's diagram or start a simulation of the model, Simulink checks whether the buses connected to the blocks have the properties specified by the bus objects. If not, Simulink halts and displays an error message.

You can use the Model Explorer's **Add > Simulink Bus** command (see "Using the Model Explorer to Create Data Objects"), the Simulink Bus Editor (see "Using Bus Objects"), or MATLAB commands (see "Working with Data Objects") to create bus objects in the base MATLAB workspace. If you attempt to create an alias in a model workspace, Simulink displays an error. You must use the Bus Editor or the MATLAB command line to set the properties of a bus object. Simulink also provides a set of utility functions for creating and saving bus objects. See the documentation for the following functions for more information:

- `Simulink.Bus.save`
- `Simulink.Bus.createObject`
- `Simulink.Bus.cellToObject`



## Property Dialog Box

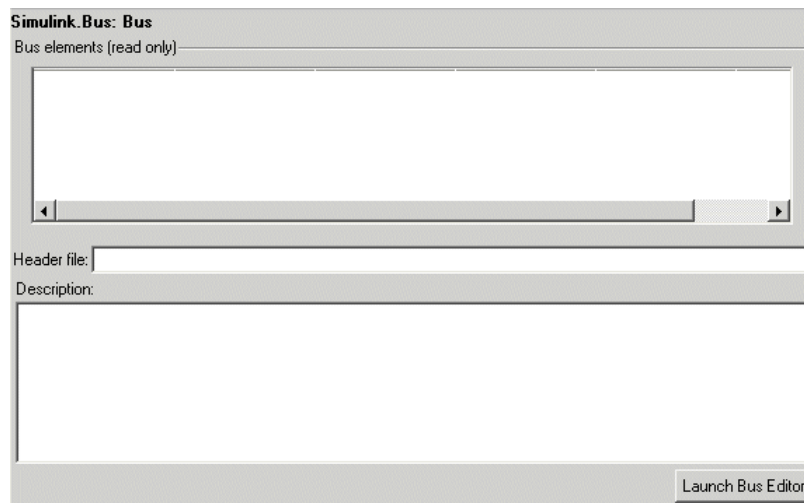

### Bus elements

Table that displays the properties of the bus's elements. You cannot edit this table. You must use either the Simulink **Bus Editor** (see “Using Bus Objects” in *Using Simulink*) or MATLAB commands to add or delete bus elements or change the properties of existing bus elements. To launch the bus editor, click the **Launch Bus Editor** button at the bottom of this dialog box or select **Bus Editor** from the model editor's **Tools** menu.

### Header file

Name of a C header file that declares the structure of this bus. This field is intended for use by Real-Time Workshop (see “Code Generation with User-Defined Data Types” *Real-Time Workshop Embedded Coder User's Guide*). Simulink ignores this field.

### Description

Description of this structure. This field is intended for you to use to document this bus. Simulink itself does not use this field.

# Simulink.Bus

---

## Properties

Name	Access	Description
Description	RW	String that describes this bus. This property is intended for user use. Simulink itself does not use it. (Description)
Elements	RW	An array of Simulink.BusElement objects that define the names, data types, dimensions, and other properties of the bus's elements. The elements must have unique names. (Bus elements)
HeaderFile	RW	String that specifies the name of a C header file that declares the structure of this bus. This property is intended for use by Real-Time Workshop. Simulink does not use it. (Header file)

## See Also

Simulink.BusElement

**Purpose** Describe element of signal bus

**Description** Objects of this class define elements of buses defined by objects of the Simulink.Bus class.

## Property Summary

Name	Description
“Complexity”	Numeric type of this bus element.
“DataType”	Data type of this bus element.
“Dimensions”	Dimensions of this bus element.
“Name”	Name of this bus element.
“SampleTime”	Sample time of this bus element.
“SamplingMode”	Sampling mode of this bus element.

## Property Dialog Box

Simulink.BusElement: BusElement

Name:

Data Type:  >>

Dimensions:  Complexity:

Sample time:  Sampling mode:

## Properties

Complexity

Numeric type ('real' or 'complex') of this element. Must be 'real' if this bus element is itself a bus.

Data Type: string

# Simulink.BusElement

---

Access: RW

---

## Data Type

Name of the data type of this element. The value of this field can be the name of a

- built-in Simulink data type, e.g., double or uint8
- Simulink.NumericType object, with one exception. The exception is a Simulink.NumericType whose Category is Fixed-point: unspecified scaling.

---

**Note** Fixed-point: unspecified scaling is a partially specified type whose definition is completed by the block that uses the Simulink.NumericType. Forbidding its use for bus elements avoids creating bus elements that have different data types depending on where they are used.

---

- Simulink.Bus object. This allows you to create bus objects that specify hierarchical buses, i.e., buses that contain other buses.

Click the **Show data type assistant** button  to display the **Data Type Assistant**, which helps you set the **Data type** parameter. (See “Using the Data Type Assistant” in *Using Simulink*.)

Data Type: string

Access: RW

---

## Dimensions

A vector specifying the dimensions of this element. Must be 1 if this element is itself a bus.

Data Type: array.

Access: RW

---

Name

Name of this element.

Data Type: string

Access: RW

---

SampleTime

Size of the interval between times when this signal's value must be recomputed. Must be -1 (inherited) if this bus element is itself a bus or if the bus that includes this element passes through a block that changes the bus's sample time, such as a Rate Transition block. See "Specifying Sample Time" for more information.

Data Type: double

Access: RW

---

SamplingMode

Sampling mode of this element. Must be sample-based if this element is itself a bus. This field is intended to be used by applications based on Simulink.

Data Type: string

Access: RW

## See Also

Simulink.Bus

# Simulink.ConfigSet

---

**Purpose** Access model configuration set

**Description** Instances of this handle class allow you to write programs to create, modify, and attach configuration sets to models. See “Configuration Sets” and “Configuration Set API” for more information.

## Property Summary

Name	Description
“Components”	Components of the configuration set.
“Description”	Description of the configuration set.
“Name”	Name of the configuration set.
“SimulationMode”	Mode used for simulation with this configuration.

---

**Note** You can use the **Model Configuration** dialog box to set the Name and Description properties of a configuration set. See “Model Configuration Dialog” for more information.

---

## Method Summary

Name	Description
“attachComponent”	Attach a component to a configuration set.
“copy”	Create a copy of a configuration set.
“getComponent”	Get a component of a configuration set.
“getFullName”	Get the full pathname of a configuration set.
“getModel”	Get the handle of the model that owns a configuration set.
“get_param”	Get the value of a configuration set parameter.
“isActive”	Determine whether a configuration set is the active set of the model that owns it.

Name	Description
“isValidParam”	Determine whether a specified parameter is a valid parameter of a configuration set.
“setPropEnabled”	Prevent or allow a user to change a parameter.
“set_param”	Set the value of a configuration set parameter.

## Properties

---

Components

### Description

Array of `Simulink.ConfigComponent` objects representing the components of the configuration set, e.g., solver parameters, data import/export parameters, etc.

### Data Type

array

### Access

RW

---

Description

### Description

Description of the configuration set. You can use this property to provide additional information about a configuration set, such as its purpose. This field can remain blank.

### Data Type

string

### Access

RW

---

Name

### Description

Configuration set's name. This name represents the configuration set in the Model Explorer.

# Simulink.ConfigSet

---

**Data Type**

string

**Access**

RW

---

SimulationMode

**Description**

Model's simulation mode. Valid values are normal, accelerator, or external.

**Data Type**

string

**Access**

RW

---

## Methods

attachComponent

**Purpose**

Attach a component to this configuration set.

**Syntax**

attachComponent(*component*)

**Arguments**

*component*

Instance of Simulink.ConfigComponent class.

**Description**

This method replaces a component in this configuration set with a component having the same name.

**Example**

The following example replaces the solver component of the active configuration set of model A with the solver component of the active configuration set of model B.



```
hCs = getActiveConfigSet('B');  
hSolverConfig = hCs.getComponent('Solver');  
hSolverConfig = hSolverConfig.copy;  
hCs = getActiveConfigSet('A');  
hCs.attachComponent(hSolverConfig);
```

---

copy

**Purpose**

Create a copy of this configuration set.

**Syntax**

copy

**Description**

This method creates a copy of this configuration set.

---

**Note** You must use this method to create copies of configuration sets. This is because `Simulink.ConfigSet` is a handle class. See “Handle Versus Value Classes” in *Using Simulink* for more information.

---

---

getComponent

**Purpose**

Get a component of this configuration set.

**Syntax**

getComponent(*componentName*)

**Arguments**

*componentName*

String specifying the name of the component to be returned.

**Description**

Returns the specified component. Omit the argument to get a list of the names of the components that this configuration set contains.

## Example

The following code gets the solver component of the active configuration set of the currently selected model.

```
hCs = getActiveConfigSet(gcs);  
hSolverConfig = hCs.getComponent('Solver');
```

The following code displays the names of the components of the currently selected model's active configuration set at the MATLAB command line.

```
hCs = getActiveConfigSet(gcs);  
hCs.getComponent
```

---

getFullName

### Purpose

Get the full pathname of a configuration set.

### Syntax

getFullName

### Description

This method returns a string specifying the full pathname of a configuration set, e.g., 'vdp/Configuration'.

---

getModel

### Purpose

Get the model that owns this configuration set.

### Syntax

getModel

### Description

Returns a handle to the model that owns this configuration set.

## Example

The following command opens the block diagram of the model that owns the configuration set referenced by the MATLAB workspace variable `hCs`.

```
open_system(hCs.getModel);
```

---

`get_param`

## Purpose

Get the value of a configuration set parameter.

## Syntax

```
get_param(paramName)
```

## Arguments

*paramName*

String specifying the name of the parameter whose value is to be returned.

## Description

This method returns the value of the specified parameter. Specifying *paramName* as 'ObjectParameters' returns the names of the valid parameters in the configuration set.

## Example

The following command gets the name of the solver used by the selected model's active configuration.

```
hAcs = getActiveConfigSet(bdroot);  
hAcs.get_param('SolverName');
```

---

**Note** You can also use the `get_param` model construction command to get the values of parameters of a model's active configuration set, e.g., `get_param(bdroot, 'SolverName')` gets the solver name of the currently selected model.

---

---

isActive

## **Purpose**

Determine whether this configuration set is its model's active configuration set.

## **Syntax**

isActive

## **Description**

Returns true if this configuration set is the active configuration set of the model that owns this configuration set.

---

isValidParam

## **Purpose**

Determine whether a specified parameter is a valid parameter of this configuration set. A parameter is valid if it is compatible with other parameters in the configuration set. For example, if SolverType is set to 'variable-step', FixedStep is an invalid parameter.

## **Syntax**

isValidParam(*paramName*)

## **Arguments**

*paramName*

String specifying the name of the parameter whose validity is to be determined.

## **Description**

This method returns true if the specified parameter is a valid parameter of this configuration set; otherwise, it returns false.

## **Example**

The following code sets the parameter StopTime only if it is a valid parameter of the currently selected model's active configuration set.

```
hAcs = getActiveConfigSet(gcs);
if hAcs.isValidParam('StopTime')
    set_param('StopTime', '20');
```

end

---

setPropEnabled

### **Purpose**

Enable a configuration set parameter to be changed.

### **Syntax**

`setPropEnabled(paramName, isEnabled)`

### **Arguments**

*paramName*

Name of the parameter whose value is to be set.

*isEnabled*

Specify as true to enable parameter; as false, to disable the parameter.

### **Description**

This method sets the enabled status the parameter specified by `paramName` to the value specified by `isEnabled`. Disabling a parameter prevents the user from changing it.

### **Example**

The following code prevents the user from setting the simulation stop time of the currently selected model.

```
hAcs = getActiveConfigSet(gcs);  
hAcs.setPropEnabled('StopTime', false);
```

---

set\_param

### **Purpose**

Set the value of a configuration set parameter.

### **Syntax**

`set_param(paramName, paramValue)`

## Arguments

paramName

Name of the parameter whose value is to be set.

paramValue

Value to assign to the parameter.

## Description

This method sets the configuration set parameter specified by paramName to the value specified by paramValue.

## Example

The following command sets the simulation stop time of the selected model's active configuration.

```
hAcs = getActiveConfigSet(gcs);  
hAcs.set_param('StopTime', '20');
```

---

**Note** You can also use the set\_param model construction command to set the parameters of the active configuration set, e.g., set\_param(gcs, 'StopTime', '20') sets the simulation stop time of the currently selected model.

---

**Purpose** Link model to configuration set stored independently of any model

**Description** Instances of this handle class allow a model to reference configuration sets that exist outside any model. See “Configuration Sets”, “Configuration Set API”, and “Referencing Configuration Sets” for more information.

**Property Summary**

Name	Description
“Description”	Description of the configuration reference.
“Name”	Name of the configuration reference.
“WSVarName”	Name of the workspace variable that contains the referenced configuration set.

**Note** You can use the **Configuration Reference** dialog box to set the Name, Description, and WSVarName properties of a configuration reference. See “Creating and Attaching a Configuration Reference” for details.

**Method Summary**

Name	Description
“copy”	Create a copy of a configuration reference.
“getFullName”	Get the full pathname of a configuration reference.
“getModel”	Get the handle of the model that owns a configuration reference.
“get_param”	Get the value of a configuration set parameter indirectly through a configuration reference.
“getRefConfigSet”	Get the configuration set specified by a configuration reference.

# Simulink.ConfigSetRef

---

Name	Description
“isActive”	Determine whether a configuration reference is the active configuration object of the model.
“refresh”	Update configuration reference after any change to properties or configuration set availability.

## Properties

---

Description

### Description

Description of the configuration reference. You can use this property to provide additional information about a configuration reference, such as its purpose. This field can remain blank.

### Data Type

string

### Access

RW

---

Name

### Description

Name of the configuration reference. This name represents the configuration reference in the GUI.

### Data Type

string

### Access

RW

---

WSVarName

### Description

Name of the workspace variable that contains the referenced configuration set.



**Data Type**

string

**Access**

RW

## Methods

---

copy

**Purpose**

Create a copy of this configuration reference.

**Syntax**

copy

**Description**

This method creates a copy of this configuration set.

---

**Note** You must use this method to create copies of configuration references. This is because `Simulink.ConfigSetRef` is a handle class. See “Handle Versus Value Classes” for more information.

---

---

getFullName

**Purpose**

Get the full pathname of a configuration reference.

**Syntax**

getFullName

**Description**

This method returns a string specifying the full pathname of a configuration reference, e.g., 'vdp/Configuration'.

---

getModel

**Purpose**

Get the model that owns this configuration reference.

# Simulink.ConfigSetRef

---

## Syntax

`getModel`

## Description

Returns a handle to the model that owns this configuration reference.

## Example

The following command opens the block diagram of the model that owns the configuration set referenced by the MATLAB workspace variable `hCr`.

```
open_system(hCr.getModel);
```

---

`get_param`

## Purpose

Get the value of a configuration set parameter indirectly through a configuration reference.

## Syntax

```
get_param(paramName)
```

## Arguments

`paramName`

String specifying the name of the parameter whose value is to be returned.

## Description

This method returns the value of the specified parameter from the configuration set to which the configuration reference points. To obtain this value, the method uses the value of `WSVarName` to retrieve the configuration set, then retrieves the value of `paramName` from that configuration set. Specifying `paramName` as `'ObjectParameters'` returns the names of all valid parameters in the configuration set. If a valid configuration set is not attached to the configuration reference, the method returns unreliable values.

The inverse method, `set_param`, is not defined for configuration references. To obtain a parameter value through a configuration reference, you must first use the `getRefConfigSet` method to retrieve

the configuration set from the reference, then use `set_param` directly on the configuration set itself.

You can also use the `get_param` model construction command to get the values of parameters of a model's active configuration set, e.g., `get_param(bdroot, 'SolverName')` gets the solver name of the currently selected model.

### Example

The following command gets the name of the solver used by the selected model's active configuration.

```
hAcs = getActiveConfigSet(bdroot);  
hAcs.get_param('SolverName');
```

---

## getRefConfigSet

### Purpose

Get the configuration set specified by a configuration reference

### Syntax

```
getRefConfigSet
```

### Description

Returns a handle to the configuration set specified by the `WSVarName` property of a configuration reference.

---

## isActive

### Purpose

Determine whether this configuration set is its model's active configuration set.

### Syntax

```
isActive
```

### Description

Returns true if this configuration set is the active configuration set of the model that owns this configuration set.

---

refresh

**Purpose**

Update configuration reference after any change to properties or configuration set availability

**Syntax**

refresh

**Description**

Updates a configuration reference after using the API to change any property of the reference, or after providing a configuration set that did not exist at the time the set was originally specified in `WSVarName`. If you omit executing `refresh` after any such change, the configuration reference handle will be stale, and using it will give incorrect results.

**Purpose** Run Model Advisor from M-file

**Description** Use instances of this class in M-file programs to run the Model Advisor, for example, to perform a standard set of checks. Simulink creates an instance of this object for each model that you open in the current MATLAB session. To get a handle to a model's Model Advisor object, execute the following command

```
ma = Simulink.ModelAdvisor.getModelAdvisor(model);
```

where *model* is the name of the model or subsystem that you want to check. Your program can then use the Model Advisor object's methods to initialize and run the Model Advisor's checks.

### About Title IDs

Many `Simulink.ModelAdvisor` object methods require or return title IDs. A *title ID* is a string that identifies a Model Advisor check or task. A title ID is often, but not necessarily, the same as the title of the check or task that it identifies. Hence, its name. A `Simulink.ModelAdvisor` object includes methods that enable you to retrieve the title ID or IDs for all checks and tasks, checks belonging to groups and tasks, the active check, and selected checks and tasks. See the `Simulink.ModelAdvisor` "Method Summary" for more information.

### Method Summary

Name	Description
"closeReport"	Close Model Advisor report.
"deselectCheck"	Deselect check(s).
"deselectCheckAll"	Deselect all checks.
"deselectCheckForGroup"	Deselect a group of checks.
"deselectCheckForTask"	Deselect checks that belong to a specified task or set of tasks.
"deselectTask"	Deselect task(s).

# Simulink.ModelAdvisor

---

<b>Name</b>	<b>Description</b>
“deselectTaskAll”	Deselect all tasks.
“displayReport”	Display Model Advisor report.
“exportReport”	Copy report to a specified location.
“getBaselineMode”	Get baseline mode setting for the Model Advisor.
“getCheckAll”	Get the title IDs of the checks performed by the Model Advisor.
“getCheckForGroup”	Get checks belonging to a check group.
“getCheckForTask”	Get checks belonging to a task.
“getCheckResult”	Get check results.
“getCheckResultData”	Get check result data.
“getCheckResultStatus”	Get pass/fail status of a check or set of checks.
“getGroupAll”	Get the title IDs of the groups of tasks performed by the Model Advisor.
“getModelAdvisor”	Get the Model Advisor for a model or subsystem.
“getSelectedCheck”	Get selected checks.
“getSelectedSystem” on page 7-66	Get path of system currently targeted by the Model Advisor.
“getSelectedTask”	Get selected tasks.

<b>Name</b>	<b>Description</b>
“getTaskAll”	Get the title IDs of the tasks performed by the Model Advisor.
“Simulink.ModelAdvisor.reportExists”	Determine whether a report exists for a system or subsystem.
“runCheck”	Run selected checks.
“runTask”	Run checks for selected tasks.
“selectCheck”	Select check(s).
“selectCheckAll”	Select all checks.
“selectCheckForGroup”	Select a group of checks.
“selectCheckForTask”	Select checks that belong to a specified task.
“selectTask”	Select task(s).
“selectTaskAll”	Select all tasks.
“setBaselineMode”	Set baseline mode for the Model Advisor.
“setCheckResult”	Set result for the currently running check.
“setCheckResultData”	Set result data for the currently running check.
“setCheckResultStatus”	Set pass/fail status for the currently running check.
“verifyCheckRan”	Verify that checks have run.
“verifyCheckResult”	Generate a baseline set of check results or compare the current set of results to the baseline results.

Name	Description
“verifyCheckResultStatus”	Verify that a model has passed or failed a set of checks.
“verifyHTML”	Generate a baseline report or compare the current report to a baseline report.

## Methods

### closeReport

#### Purpose

Close Model Advisor report.

#### Syntax

```
closeReport
```

#### Description

Closes the report associated with this Model Advisor object, which closes the Model Advisor window.

#### See Also

“displayReport”

### deselectCheck

#### Purpose

Deselect a check.

#### Syntax

```
success = deselectCheck(titleID)
```

#### Arguments

titleID

String or cell array that specifies the title IDs of the checks to be deselected

success

True (1) if the check is deselected.



**Description**

This method deselects the checks specified by `titleID`.

---

**Note** This method cannot deselect disabled checks.

---

**See Also**

“`getCheckAll`”, “`deselectCheckForGroup`”, “`selectCheck`”

**deselectCheckAll****Purpose**

Deselect all checks.

**Syntax**

```
success = deselectCheckAll
```

**Arguments**

`success`

True (1) if all checks are deselected.

**Description**

Deselects all checks that are not disabled.

**See Also**

“`selectCheckAll`”

**deselectCheckForGroup****Purpose**

Deselect a group of checks.

**Syntax**

```
success = deselectCheckForGroup(groupName)
```

**Arguments**

`groupName`

String or cell array that specifies the names of the groups to be deselected

`success`

True (1) if the method succeeds in deselecting the specified group.

**Description**

Deselects a specified group of checks.

**See Also**

“selectCheckForGroup”

**deselectCheckForTask****Purpose**

Deselect checks that belong to a specified task or set of tasks.

**Syntax**

```
success = deselectCheckForTask(titleID)
```

**Arguments**

titleID

String or cell array of strings that specify the title IDs of tasks whose checks are to be deselected.

success

True (1) if the specified tasks are deselected.

**Description**

Deselects checks belonging to the tasks specified by the titleID argument.

**See Also**

“getTaskAll”, “selectCheckForTask”

**deselectTask****Purpose**

Deselect a task.

**Syntax**

```
success = deselectTask(titleID)
```

**Arguments**

titleID

String or cell array that specifies the title ID of tasks to be deselected

success

True (1) if the method succeeded in deselecting the specified tasks

**Description**

Deselects the tasks specified by `titleID`.

**See Also**

“selectTask”, “getTaskAll”

**deselectTaskAll****Purpose**

Deselect all tasks.

**Syntax**

```
success = deselectTaskAll
```

**Arguments**

`success`

True (1) if this method succeeds in deselecting all tasks

**Description**

Deselects all tasks.

**See Also**

“selectTaskAll”

**displayReport****Purpose**

Display report in Model Advisor.

**Syntax**

```
displayReport
```

**Description**

Displays the report associated with this Model Advisor object in the Model Advisor window. The report includes the most recent results of running checks on the system associated with this Model Advisor object and the current selection status of checks, groups, and tasks for the system.

**See Also**

“Simulink.ModelAdvisor.reportExists”

## **exportReport**

### **Purpose**

Create a copy of a report generated by Model Advisor.

### **Syntax**

```
[success message] = exportReport(destination)
```

### **Arguments**

destination

Pathname of copy to be made of the report file

success

True (1) if this method succeeded in creating a copy of the report at the specified location

message

Empty if the copy was successful; otherwise, the reason the copy did not succeed.

### **Description**

This method creates a copy of the last report generated by the Model Advisor and stores the copy at the specified location.

### **See Also**

“Simulink.ModelAdvisor.reportExists”

## **getBaselineMode**

### **Purpose**

Determine whether the Model Advisor is in baseline data generation mode.

### **Syntax**

```
mode = getBaselineMode
```

### **Arguments**

mode

Boolean value indicating baseline mode

**Description**

The mode output variable returns true if the Model Advisor is in baseline data mode. Baseline mode causes the Model Advisor's verification methods, e.g., "verifyHTML", to generate baseline data.

**See Also**

"setBaselineMode", "verifyHTML", "verifyCheckResult", "verifyCheckResultStatus"

**getCheckAll****Purpose**

Get the title IDs of all checks.

**Syntax**

```
titleIDs = getCheckAll
```

**Arguments**

titleIDs

Cell array of strings specifying the title IDs of all checks performed by the Model Advisor

**Description**

Returns a cell array of strings specifying the title IDs of all checks performed by the Model Advisor.

**See Also**

"getTaskAll", "getGroupAll"

**getCheckForGroup****Purpose**

Get checks that belong to a check group.

**Syntax**

```
titleIDs = getCheckForTask(groupName)
```

**Arguments**

groupName

String specifying the name of a group

titleIDs

Cell array of title IDs

## **Description**

Returns a cell array of title IDs of the tasks belonging to the group specified by groupName.

## **See Also**

“getCheckForTask”

## **getCheckForTask**

### **Purpose**

Get the checks that belong to a task.

### **Syntax**

```
checkIDs = getCheckForTask(taskID)
```

### **Arguments**

taskID

Title ID of a task

checkIDs

Cell array of title IDs of checks belonging to the specified task

## **Description**

Returns a cell array of title IDs of the checks belonging to the task specified by taskID.

## **See Also**

“getCheckForGroup”

## **getCheckResult**

### **Purpose**

Get the results of running a check or set of checks.

### **Syntax**

```
result = getCheckResult(titleID)
```

### **Arguments**

titleID

Title ID of a check or cell array of check title IDs

result

A check result or cell array of check results

## Description

Gets check results for the specified checks. The format of the results depends on the checks that generated the data.

---

**Note** This method is intended for accessing check results generated by custom checks created with the Model Advisor's customization API, an optional feature available with Simulink Verification and Validation (see the online Simulink Verification and Validation documentation for more information).

---

## See Also

“getCheckResultData”, “getCheckResultStatus”

## getCheckResultData

### Purpose

Get the data resulting from running a check or set of checks.

### Syntax

```
result = getCheckResultData(titleID)
```

### Arguments

titleID

Check title ID or cell array of check title IDs

result

Data from a check result or cell array of data from check results

### Description

Gets the check result data for the specified checks. The format of the data depends on the checks that generated the data.

---

**Note** This method is intended for accessing check result data generated by custom checks created with the Model Advisor’s customization API, an optional feature available with Simulink Verification and Validation (see the online Simulink Verification and Validation documentation for more information).

---

**See Also**

“getCheckResult”, “getCheckResultStatus”

**getCheckResultStatus**

**Purpose**

Get the pass/fail status of a check or set of checks.

**Syntax**

```
result = getCheckResultStatus(titleID)
```

**Arguments**

titleID

Check title ID or cell array of check title IDs

result

Boolean or a cell array of Boolean values indication the pass/fail status of a check or set of checks

**Description**

Invoke this method after running a set of checks to determine whether the checks passed or failed.

**See Also**

“getCheckResult”, “getCheckResultData”

**getGroupAll**

**Purpose**

Get all groups of checks performed by the Model Advisor.

**Syntax**

```
titleIDs = getGroupAll
```



## Arguments

titleIDs

Cell array of title IDs of all groups of checks performed by the Model Advisor.

## Description

Returns a cell array of title IDs of all groups of checks performed by the Model Advisor.

## See Also

“getCheckAll”, “getTaskAll”

## getModelAdvisor

### Purpose

Get a Model Advisor object for a system or subsystem.

### Syntax

```
obj = Simulink.ModelAdvisor.getModelAdvisor(system)
obj = Simulink.ModelAdvisor.getModelAdvisor(system, 'new')
```

### Arguments

system

Name of model for which the Model Advisor is to be gotten

'new'

Required when changing Model Advisor working scope from one system to another without closing the previous session.

Alternatively, you can close the previous session before invoking getModelAdvisor, in which case 'new' can be omitted.

obj

Model Advisor object

### Description

This static method (see “Static Methods”) creates and returns an instance of Simulink.ModelAdvisor class for the model or subsystem specified by system.

## **getSelectedCheck**

### **Purpose**

Get the currently selected checks.

### **Syntax**

```
titleIDs = getSelectedCheck
```

### **Arguments**

titleIDs

Cell array of title IDs of currently selected checks

### **Description**

Returns the checks currently selected in the Model Advisor.

### **See Also**

“getSelectedTask”

## **getSelectedSystem**

### **Purpose**

Get system currently targeted by the Model Advisor.

### **Syntax**

```
path = getSelectedSystem
```

### **Arguments**

path

Path of the system selected system

### **Description**

Gets the path of the system currently targeted by the Model Advisor, i.e., the system or subsystem most recently selected for checking either interactively by the user or programmatically via `Simulink.ModelAdvisor.getModelAdvisor`.

### **See Also**

“getModelAdvisor”

## **getSelectedTask**

### **Purpose**

Get selected tasks.

**Syntax**

`titleIDs = getSelectedTask`

**Arguments**

`titleIDs`

Cell array of title IDs of currently selected tasks.

**Description**

Returns the tasks currently selected in the Model Advisor.

**See Also**

“getSelectedCheck”

**getTaskAll****Purpose**

Get the tasks performed by the Model Advisor.

**Syntax**

`titleIDs = getTaskAll`

**Arguments**

`titleIDs`

Cell array of title IDs of tasks performed by the Model Advisor.

**Description**

Returns a cell array of title IDs of tasks performed by the Model Advisor.

**See Also**

“getCheckAll”, “getGroupAll”

**Simulink.ModelAdvisor.reportExists****Purpose**

Determine whether a report exists for a model or subsystem.

**Syntax**

`exists = reportExists('system')`

**Arguments**

`'system'`

String specifying pathname of a system or subsystem

`exists`

True (1) if a report exists for system

## **Description**

This method returns true (1) if a report file exists for the model (system) or subsystem specified by system in the slprj/modeladvisor subdirectory of MATLAB's working directory.

## **See Also**

“exportReport”

## **runCheck**

### **Purpose**

Run the currently selected checks.

### **Syntax**

`success = runCheck`

### **Arguments**

`success`

True (1) if the checks were run.

## **Description**

Runs the checks currently selected in the Model Advisor. Invoking this method is equivalent to selecting the **Run Advisor** button on the Model Advisor window.

## **See Also**

“selectCheck”

## **runTask**

### **Purpose**

Run the currently selected tasks.

### **Syntax**

`success = runTask`

### **Arguments**

`success`

True (1) if the tasks were run.

**Description**

Runs the tasks currently selected in the Model Advisor. Invoking this method is equivalent to selecting the **Run Advisor** button on the Model Advisor window.

**See Also**

“selectTask”

**selectCheck****Purpose**

Select a check.

**Syntax**

```
success = selectCheck(titleID)
```

**Arguments**

titleID

Title ID or cell array of title IDs of checks to be selected

success

True (1) if this method succeeded in selecting the specified checks

**Description**

This method cannot select a check that is disabled.

**See Also**

“selectCheckAll”, “selectCheckForGroup”, “deselectCheck”

**selectCheckAll****Purpose**

Select all checks.

**Syntax**

```
success = selectCheckAll
```

**Arguments**

success

True (1) if this method succeeded in selecting all checks.

**Description**

Selects all checks that are not disabled.

**See Also**

“selectCheck”, “selectCheckForGroup”, “deselectCheck”

**selectCheckForGroup****Purpose**

Select a group of checks.

**Syntax**

```
success = selectCheckForGroup(titleID)
```

**Arguments**

titleID

Title ID or cell array of group title IDs

success

True (1) if this method succeeded in selecting the specified groups

**Description**

Selects the groups specified by titleID.

**See Also**

“deselectCheckForGroup”

**selectCheckForTask****Purpose**

Select checks that belong to a specified task or set of tasks.

**Syntax**

```
success = selectCheckForTask(titleID)
```

**Arguments**

titleID

Title ID or cell array of title IDs of tasks whose checks are to be selected

success

True (1) if this method succeeded in selecting the checks for the specified tasks

**Description**

Selects checks belonging to the tasks specified by the titleID argument.

**See Also**

“deselectCheckForTask”

**selectTask****Purpose**

Select a task.

**Syntax**

```
success = selectTask(titleID)
```

**Arguments**

titleID

Title ID or cell array of title IDs of the task to be selected

success

True (1) if this method succeeds in selecting the specified tasks

**Description**

Selects a task.

**See Also**

“deselectTask”

**selectTaskAll****Purpose**

Select all tasks.

**Syntax**

```
success = selectTaskAll
```

**Arguments**

success

True (1) if this method succeeds in selecting all tasks

**Description**

Selects all tasks.

**See Also**

“deselectTaskAll”

## **setBaselineMode**

### **Purpose**

Set the baseline data generation mode for the Model Advisor.

### **Syntax**

```
setBaselineMode(mode)
```

### **Arguments**

mode

Boolean value indicating setting of Model Advisor's baseline mode, either on (true) or off (false)

### **Description**

Sets the Model Advisor's baseline mode to mode. Baseline mode causes the Model Advisor's verify methods to generate baseline comparison data for verifying the results of a Model Advisor run.

### **See Also**

“getBaselineMode”, “verifyCheckResult”, “verifyHTML”

## **setCheckResult**

### **Purpose**

Set the result for the currently running check.

### **Syntax**

```
success = setCheckResult(result)
```

### **Arguments**

result

String or cell array that specifies the result of the currently running task

success

True (1) if this method succeeds in setting the check result

### **Description**

Sets the check result for the currently running check. Only the check's callback function can invoke this method.



---

**Note** This method is intended for use with custom checks created with the Model Advisor’s customization API, an optional feature available with Simulink Verification and Validation (see the online Simulink Verification and Validation documentation for more information).

---

**See Also**

“getCheckResult”, “setCheckResultData”, “setCheckResultStatus”

**setCheckResultData**

**Purpose**

Set the result data for the currently running check.

**Syntax**

```
success = setCheckResultData(data)
```

**Arguments**

data

Result data to be set

success

True (1) if this method succeeds in setting the result data for the current check

**Description**

Sets the check result data for the currently running check. Only the check’s callback function can invoke this method.

---

**Note** This method is intended for use with custom checks created with the Model Advisor’s customization API, an optional feature available with Simulink Verification and Validation and Verification (see the online Simulink Verification and Validation documentation for more information).

---

**See Also**

“getCheckResultData”, “setCheckResult”, “setCheckResultStatus”

## **setCheckResultStatus**

### **Purpose**

Set the pass/fail status for the currently running check.

### **Syntax**

```
success = setCheckResultStatus(status)
```

### **Arguments**

status

Boolean value that indicates the status of the check that just ran, either pass (true) or fail (false)

success

True (1) if the status was set.

### **Description**

Sets the pass/fail status for the currently running check to status. Only the check's callback function can invoke this method.

---

**Note** This method is intended for use with custom checks created with the Model Advisor's customization API, an optional feature available with Simulink Verification and Validation (see the online Simulink Verification and Validation documentation for more information).

---

### **See Also**

“getCheckResultStatus”, “setCheckResult”, “setCheckResultStatus”

## **verifyCheckRan**

### **Purpose**

Verify that the Model Advisor has run a set of checks.

### **Syntax**

```
[success, missingChecks, additionalChecks] =  
verifyCheckRan(titleIDs)
```

### **Arguments**

titleIDs

Cell array of title IDs of checks to verify

`success`

Boolean value specifying whether the checks ran

`missingChecks`

Cell array of title IDs for specified checks that ran

`additionalChecks`

Cell array of title IDs for unspecified checks that ran

## **Description**

The output variable `success` returns `true` if all the checks specified by `titleIDs` have run. If not, `success` returns `false`, `missingChecks` lists specified checks that did not run. The `additionalChecks` argument lists unspecified checks that ran.

## **See Also**

“`verifyCheckResultStatus`”

## **verifyCheckResult**

### **Purpose**

Generate a baseline Model Advisor check results file or compare the current check results to the baseline check results.

### **Syntax**

```
[success message] = verifyCheckResult(baseline, checkIDs)
```

### **Arguments**

`baseline`

Pathname of the baseline check results MAT-file

`checkIDs`

Cell array of check title IDs.

`success`

Boolean value specifying whether the method succeeded

`message`

String specifying an error message

## Description

If the Model Advisor is in baseline mode (see “setBaselineMode”), this method stores the most recent results of running the checks specified by checkIDs in a MAT-file at the location specified by baseline. If the method is unable to store the check results at the specified location, it returns false in the output variable success and the reason for the failure in the output variable message. If the Model Advisor is not in baseline mode, this method compares the most recent results of running the checks specified by checkIDs with the report specified by baseline. If the current results match the baseline results, this method returns true as the value of the success output variable.

---

**Note** You must run the checks specified by checkIDs (see “runCheck”) before invoking verifyCheckResult.

---

This method enables you to compare the most recent check results generated by the Model Advisor with a baseline set of check results. You can use the method to generate the baseline report as well as perform current-to-baseline result comparisons. To generate a baseline report, put the Model Advisor in baseline mode, using “setBaselineMode”. Then invoke this method with the baseline argument set to the location where you want to store the baseline results. To perform a current-to-baseline report comparison, first ensure that the Model Advisor is not in baseline mode (see “getBaselineMode”). Then invoke this method with the path of the baseline report as the value of the baseline input argument.

## See Also

“setBaselineMode”, “getBaselineMode”, “runCheck”,  
“verifyCheckResultStatus”

## verifyCheckResultStatus

### Purpose

Verify that a model has passed or failed a set of checks.

## Syntax

```
[success message] = verifyCheckResultStatus(baseline,  
checkIDs)
```

## Arguments

baseline

Array of Boolean variables

checkIDs

Cell array of check title IDs.

success

Boolean value specifying whether the method succeeded

message

String specifying an error message

## Description

This method compares the pass/fail (true/false) statuses from the most recent running of the checks specified by checkIDs with the Boolean values specified by status. If the statuses match the baseline, this method returns true as the value of the success output variable.

---

**Note** You must run the checks specified by checkIDs (see “runCheck”) before invoking verifyCheckResultStatus.

---

## See Also

“runCheck”

## verifyHTML

### Purpose

Generate a baseline Model Advisor report or compare the current report to a baseline report.

### Syntax

```
[success message] = verifyHTML(baseline)
```

## Arguments

`baseline`

Pathname of a Model Advisor report

`success`

Boolean value specifying whether the method succeeded

`message`

String specifying an error message

## Description

If the Model Advisor is in baseline mode (see “`setBaselineMode`”), this method stores the report most recently generated by the Model Advisor at the location specified by `baseline`. If the method is unable to store a copy of the report at the specified location, it returns `false` in the output variable `success` and the reason for the failure in the output variable `message`. If the Model Advisor is not in baseline mode, this method compares the report most recently generated by the Model Advisor with the report specified by `baseline`. If the current report has exactly the same content as the baseline report, this method returns `true` as the value of the `success` output variable.

This method enables you to compare a report generated by the Model Advisor with a baseline report to determine if they differ. You can use the method to generate the baseline report as well as perform current-to-baseline report comparisons. To generate a baseline report, put the Model Advisor in baseline mode. Then invoke this method with the `baseline` argument set to the location where you want to store the baseline report. To perform a current-to-baseline report comparison, first ensure that the Model Advisor is not in baseline mode (see “`getBaselineMode`”). Then invoke this method with the path of the baseline report as the value of the `baseline` input argument.

## See Also

“`setBaselineMode`”, “`getBaselineMode`”, “`verifyCheckResult`”

## Purpose

Container for model's signal data logs

## Description

Simulink creates instances of this class to contain signal logs that it creates while simulating a model (see “Logging Signals”). In particular, Simulink creates an instance of this class for a top-level model and for each model referenced by the top-level model that contains signals to be logged. Simulink assigns the `ModelDataLogs` object for the top-level model to a variable in the MATLAB workspace. The name of the variable is the name specified in the **Signal logging name** field on the **Data Import/Export** pane of the model's **Configuration Parameters** dialog box. The default value is `logout`.

A `ModelDataLogs` object has a variable number of properties. The first property, named `Name`, specifies the name of the model whose signal data the object contains or, if the model is a referenced model, the name of the Model block that references the model. The remaining properties reference objects that contain signal data logged during simulation of the model. The objects may be instances of any of the following types of objects:

- `Simulink.Timeseries`  
Log for a signal in this model.
- `Simulink.TsArray`  
Container for the logs of the elements of a root-level composite signal (e.g., a Mux or Bus Creator signal) in this model.
- `Simulink.ModelDataLogs`  
Container for the logs of a model referenced by this model.
- `Simulink.SubsysDataLogs`  
Container for the signal logs of a subsystem of this model.
- `Simulink.ScopeDataLogs`  
Container for data displayed on Scope signal viewers (see “Signal & Scope Manager” in *Using Simulink*).

# Simulink.ModelDataLogs

---

The names of the properties identify the data being logged as follows:

- For signal data logs, the name of the signal
- For a subsystem or model log container, the name of the subsystem or model, respectively
- For a scope viewer data log, the name specified on the viewer's parameter dialog box

---

**Note** If a name contains spaces, the ModelDataLogs objects specifies its name as ( ' **name** ' ) where **name** is the actual name, e.g., ( ' Brake Subsystem ' ).

---

Consider, for example, the following model.



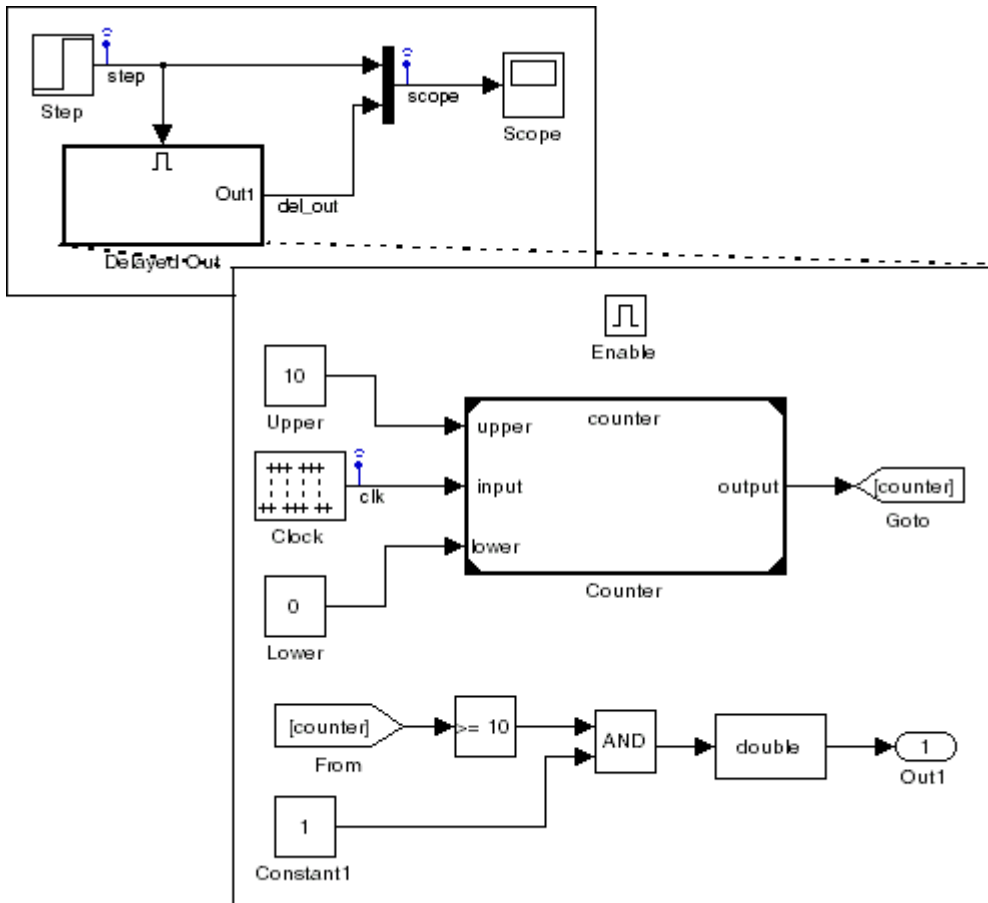

As indicated by the testpoint icons, this model specifies that Simulink should log the signals named `step` and `scope` in the model's root system and the signal named `clk` in the subsystem named `Delayed Out`. After simulation of this model, the MATLAB workspace contains the following variable:

```
>> logout
```

# Simulink.ModelDataLogs

---

```
logout =  
  
Simulink.ModelDataLogs (siglgex):  
  Name                Elements  Simulink Class  
  
  scope                2        TsArray  
  step                 1        Timeseries  
  ('Delayed Out')     2        SubsysDataLogs
```

The `logout` variable contains the signal data logged during the simulation. You can use fully qualified object names or the Simulink `unpack` command to access the signal data stored in `logout`. For example, to access the amplitudes of the `clk` signal in the Delayed Out subsystem, enter

```
>> data = logout('Delayed Out').clk;
```

or

```
>> logout.unpack('all');  
>> data = clk;
```

You can use a custom logging name or signal name when logging a signal. If you choose to use the signal name, and that signal name is a multiline one, seen in the following:

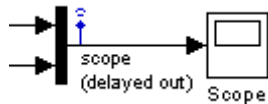

include an `sprintf('\n')` between the two lines of the signal name when accessing the logged data. For example,

```
logout.(['scope' sprintf('\n') '(delayed out)'])
```

**See Also**

Simulink.Timeseries, Simulink.TsArray,  
Simulink.SubsysDataLogs, Simulink.ScopeDataLogs,  
unpack

# Simulink.ModelWorkspace

---

**Purpose** Describe model workspace

**Description** Instances of this class describe model workspaces. Simulink creates an instance of this class for each model that you open during a Simulink session. See “Working with Model Workspaces” in *Using Simulink* for more information.

## Property Summary

Name	Access	Description
DataSource	RW	Specifies the source used to initialize this workspace. Valid values are <ul style="list-style-type: none"><li>'MDL-File'</li><li>'MAT-File'</li><li>'M-Code'</li></ul>
FileName	RW	Specifies the name of the MAT-file used to initialize this workspace. Simulink ignores this property if DataSource is not 'MAT-File'.
MCode	RW	A string specifying M code used to initialize this workspace. Simulink ignores this property if DataSource is not 'M-Code'.

## Method Summary

Name	Description
“assignin”	Assign a value to a variable in the model’s workspace.
“clear”	Clear the model’s workspace.
“evalin”	Evaluate an expression in the model’s workspace.

Name	Description
“reload”	Reload the model workspace from the workspace’s data source.
“save”	Save the model’s workspace to a specified MAT-file.
“saveToSource”	Save the workspace to the MAT-file that the workspace designates as its data source.
“whos”	List the variables in the model workspace.

## Methods

---

`assignin`

### **Purpose**

Assign a value to a variable in the model’s workspace.

### **Syntax**

```
assignin('varname', varvalue)
```

### **Arguments**

`varname`

Name of the variable to be assigned a value.

`varvalue`

Value to be assigned the variable.

### **Description**

This method assigns the value specified by `varvalue` to the variable whose name is `varname`.

### **See also**

“evalin”

---

`clear`

### **Purpose**

Clear the model’s workspace.

# Simulink.ModelWorkspace

---

## **Syntax**

clear

## **Description**

This method empties the workspace of its variables.

---

evalin

## **Purpose**

Evaluate an expression in the model's workspace.

## **Syntax**

evalin('expression')

## **Arguments**

expression

A MATLAB expression to be evaluated.

## **Description**

This method evaluates expression in the model workspace.

## **See also**

“assignin”

---

reload

## **Purpose**

Reload the model workspace from the workspace's data source.

## **Syntax**

reload

## **Description**

This method reloads the model workspace from the data source specified by its DataSource parameter.

## **See also**

“saveToSource”

---

save

## **Purpose**

Save the model's workspace to a specified MAT-file.

## **Syntax**

```
save('filename')
```

## **Arguments**

filename  
Name of a MAT-file.

## **Description**

This method saves the model's workspace to the MAT-file specified by filename.

---

**Note** This method allows you to save the workspace to a file other than the file specified by the workspace's `FileName` property. If you want to save the model workspace to the file specified by the file's `FileName` property, it is simpler to use the workspace's `saveToSource` method.

---

## **Example**

```
hws = get_param('mymodel','modelworkspace')
hws.DataSource = 'MAT-File';
hws.FileName = 'workspace';
hws.assignin('roll', 30);
hws.saveToSource;
hws.assignin('roll', 40);
hws.save('workspace_test.mat');
```

## **See also**

“reload”, “saveToSource”

# Simulink.ModelWorkspace

---

---

saveToSource

## **Purpose**

Save the workspace to the MAT-file that it designates as its data source.

## **Syntax**

saveToSource

## **Description**

This method saves the model workspace designated by its FileName property.

## **Example**

```
hws = get_param('mymodel','modelworkspace')
hws.DataSource = 'MAT-File';
hws.FileName = 'params';
hws.assignin('roll', 30);
hws.saveToSource;
```

## **See also**

“save”, “reload”

---

whos

## **Purpose**

List the variables in the model workspace.

## **Syntax**

whos

## **Description**

This method lists the variables in the model’s workspace. The listing includes the size and class of the variables.



## Example

```
>> hws = get_param('myModel', 'modelworkspace');  
>> hws.assignin('k', 2);  
>> hws.whos
```

Name	Size	Bytes	Class
k	1x1	8	double array

# Simulink.MSFcnRunTimeBlock

---

**Purpose** Get run-time information about Level-2 M-file S-function block

**Description** This class allows a Level-2 M-file S-function or other M program to obtain information from Simulink and provide information to Simulink about a Level-2 M-file S-function block. Simulink creates an instance of this class for each Level-2 M-file S-function block in a model. Simulink passes the object to the callback methods of Level-2 M-File S-Functions when it updates or simulates a model, allowing the callback methods to get and provide block-related information to Simulink. See “Writing Level-2 M-File S-Functions” in *Writing S-Functions* for more information.

You can also use instances of this class in M-file programs to obtain information about Level-2 M-File S-Function blocks during a simulation. See “Accessing Block Data During Simulation” in *Using Simulink* for more information.

The Level-2 M-file S-Function template `matlabroot/toolbox/simulink/blocks/msfuntmp1.m` shows how to use a number of the following methods.

**Parent Class** Simulink.RunTimeBlock

**Derived Classes** None

## Property Summary

Name	Description
“DialogPrmsTunable”	Specifies which of the S-function’s dialog parameters are tunable.
“NextTimeHit”	Time of the next sample hit for variable sample time S-functions.

## Method Summary

Name	Description
“AllowSignalsWithMoreThan2D ”	Enable Level-2 S-function M-file to work with multidimensional signals.
“AutoRegRuntimePrms”	Register this block’s dialog parameters as run-time parameters.
“AutoUpdateRuntimePrms”	Update this block’s run-time parameters.
“IsDoingConstantOutput”	Determine whether the current simulation stage is the constant sample time stage.
“IsMajorTimeStep”	Determine whether the current simulation time step is a major time step.
“IsSampleHit”	Determine whether the current simulation time is one at which a task handled by this block is active.
“IsSpecialSampleHit”	Determine whether the current simulation time is one at which multiple tasks handled by this block are active.
“RegBlockMethod”	Register a callback method for this block.

# Simulink.MSFcnRunTimeBlock

---

Name	Description
"RegisterDataTypeFxpBinaryPoint"	Register fixed-point data type with binary point-only scaling.
"RegisterDataTypeFxpFSlopeFixExpBias"	Register fixed-point data type with [Slope Bias] scaling specified in terms of fractional slope, fixed exponent, and bias.
"RegisterDataTypeFxpSlopeBias"	Register data type with [Slope Bias] scaling.
"SetAccelRunOnTLC"	Specify whether to use this block's TLC file to generate the simulation target for the model that uses it.
"SetPreCompInpPortInfoToDynamic"	Set precompiled attributes of this block's input ports to be inherited.
"SetPreCompOutPortInfoToDynamic"	Set precompiled attributes of this block's output ports to be inherited.
"SetSimViewingDevice"	Specify whether block is a viewer.
"WriteRTWParam"	Write custom parameter information to Real-Time Workshop file.

## Properties

---

DialogPrmsTunable

### Description

Specifies whether a dialog parameter of the S-function is tunable. Tunable parameters are registered as run-time parameters when you call the “AutoRegRuntimePrms” method. Note that SimOnlyTunable parameters are not registered as run-time parameters. For example, the following lines initializes three dialog parameters where the first is tunable, the second in not tunable, and the third is tunable only during simulation.

```
block.NumDialogPrms      = 3;  
block.DialogPrmsTunable = {'Tunable','Nontunable','SimOnlyTunable'};
```

### Data Type

array

### Access

RW

---

NextTimeHit

### Description

Time of the next sample hit for variable sample-time S-functions.

### Data Type

double

### Access

RW

---

## Methods

---

AllowSignalsWithMoreThan2D

### Purpose

Enable Level-2 S-function M-file to work with multidimensional signals.

### Syntax

```
AllowSignalsWithMoreThan2D;
```

# Simulink.MSFcnRunTimeBlock

---

## **Description**

Allow Level-2 S-function M-file to use multidimensional signals. You must call the AllowSignalWidthMoreThan2D function in the Level-2 M-file S-function setup method.

---

AutoRegRuntimePrms

## **Purpose**

Register a block's tunable dialog parameters as run-time parameters.

## **Syntax**

AutoRegRuntimePrms;

## **Description**

Use in the PostPropagationSetup method to register this block's tunable dialog parameters as run-time parameters.

---

AutoUpdateRuntimePrms

## **Purpose**

Update a block's run-time parameters.

## **Syntax**

AutoRegRuntimePrms;

## **Description**

Automatically update the values of the run-time parameters during a call to ProcessParameters.

See the S-function *matlabroot/toolbox/simulink/simdemos/adapt\_lms.m* in the Simulink model *sldemo\_msfcn\_lms.mdl* for an example.

---

IsDoingConstantOutput

## **Purpose**

Determine whether this is in the constant sample time stage of a simulation.

## Syntax

```
bVal = IsDoingConstantOutput;
```

## Description

Returns true if this is the constant sample time stage of a simulation, i.e., the stage at the beginning of a simulation where Simulink computes the values of block outputs that cannot change during the simulation (see “Constant Sample Time” in *Using Simulink*). Use this method in the Outputs method of an S-function with port-based sample times to avoid unnecessarily computing the outputs of ports that have constant sample time, i.e., [inf, 0].

```
function Outputs(block)
.
.
    if block.IsDoingConstantOutput
        ts = block.OutputPort(1).SampleTime;
        if ts(1) == Inf
            %% Compute port's output.
        end
    end
end
.
.
%% end of Outputs
```

See “Specifying Port-Based Sample Times” in *Writing S-Functions* for more information.

---

```
IsMajorTimeStep
```

## Purpose.

Determine whether current time step is a major or a minor time step.

## Syntax

```
bVal = IsMajorTimeStep;
```

# Simulink.MSFcnRunTimeBlock

---

## Description

Returns true if the current time step is a major time step; false, if it is a minor time step. This method can be called only from the Outputs or Update methods.

---

IsSampleHit

## Purpose

Determine whether the current simulation time is one at which a task handled by this block is active.

## Syntax

```
bVal = IsSampleHit(stIdx);
```

## Arguments

stIdx

Global index of the sample time to be queried.

## Description

Use in Outputs or Update block methods when the M-file S-function has multiple sample times to determine whether a sample hit has occurred at stIdx. The sample time index stIdx is a global index for the Simulink model. For example, consider a model that contains three sample rates of 0.1, 0.2, and 0.5, and an M-file S-function block that contains two rates of 0.2 and 0.5. In the M-file S-function, block.IsSampleHit(0) returns true for the rate 0.1, not the rate 0.2.

This block method is similar to ssIsSampleHit for C-MEX S-functions, however ssIsSampleHit returns values based on only the sample times contained in the S-function. For example, if the model described above contained a C-MEX S-function with sample rates of 0.2 and 0.5, ssIsSampleHit(S,0,tid) returns true for the rate of 0.2.

Use port-based sample times to avoid using the global sample time index for multi-rate systems (see Simulink.BlockPortData).



---

IsSpecialSampleHit

**Purpose**

Determine whether the current simulation time is one at which multiple tasks implemented by this block are active.

**Syntax**

```
bVal = IsSpecialSampleHit(stIdx1, stIdx1);
```

**Arguments**

stIdx1

Index of sample time of first task to be queried.

stIdx2

Index of sample time of second task to be queried.

**Description**

Use in Outputs or Update block methods to ensure the validity of data shared by multiple tasks running at different rates. Returns true if a sample hit has occurred at stIdx1 and a sample hit has also occurred at stIdx2 in the same time step (similar to ssIsSpecialSampleHit for C-Mex S-functions).

---

RegBlockMethod

**Purpose**

Register a block callback method.

**Syntax**

```
RegBlockMethod(methName, methHandle);
```

**Arguments**

methName

Name of method to be registered.

methHandle

MATLAB function handle of the callback method to be registered.

# Simulink.MSFcnRunTimeBlock

---

## Description

Registers the block callback method specified by `methName` and `methHandle`. Use this method in the setup function of a Level-2 M-file S-function to specify the block callback methods that the S-function implements.

---

`RegisterDataTypeFxpBinaryPoint`

## Purpose

Register fixed-point data type with binary point-only scaling.

## Syntax

```
dtID = RegisterDataTypeFxpBinaryPoint(isSigned, wordLength,  
fractionalLength, obeyDataTypeOverride);
```

## Arguments

`isSigned`

true if the data type is signed.

false if the data type is unsigned.

`wordLength`

Total number of bits in the data type, including any sign bit.

`fractionalLength`

Number of bits in the data type to the right of the binary point.

`obeyDataTypeOverride`

true indicates that the **Data Type Override** setting for the subsystem is to be obeyed. Depending on the value of **Data Type Override**, the resulting data type could be `True Doubles`, `True Singles`, `ScaledDouble`, or the fixed-point data type specified by the other arguments of the function.

false indicates that the **Data Type Override** setting is to be ignored.

## Description

This method registers a fixed-point data type with Simulink and returns a data type ID. The data type ID can be used to specify the data types of

input and output ports, run-time parameters, and DWork states. It can also be used with all the standard data type access methods defined for instances of this class, such as “DatatypeSize”.

Use this function if you want to register a fixed-point data type with binary point-only scaling. Alternatively, you can use one of the other fixed-point registration functions:

- Use “RegisterDataTypeFxpFSlopeFixExpBias” to register a data type with [Slope Bias] scaling by specifying the word length, fractional slope, fixed exponent, and bias.
- Use “RegisterDataTypeFxpSlopeBias” to register a data type with [Slope Bias] scaling.

If the registered data type is not one of the Simulink built-in data types, a Simulink Fixed Point license is checked out.

---

## RegisterDataTypeFxpFSlopeFixExpBias

### **Purpose**

Register fixed-point data type with [Slope Bias] scaling specified in terms of fractional slope, fixed exponent, and bias

### **Syntax**

```
dtID = RegisterDataTypeFxpFSlopeFixExpBias(isSigned,  
wordLength, fractionalSlope, fixedExponent, bias,  
obeyDataTypeOverride);
```

### **Arguments**

`isSigned`

true if the data type is signed.

false if the data type is unsigned.

`wordLength`

Total number of bits in the data type, including any sign bit.

`fractionalSlope`

Fractional slope of the data type.

`fixedExponent`

Exponent of the slope of the data type.

`bias`

Bias of the scaling of the data type.

`obeyDataTypeOverride`

`true` indicates that the **Data Type Override** setting for the subsystem is to be obeyed. Depending on the value of **Data Type Override**, the resulting data type could be `True Doubles`, `True Singles`, `ScaledDouble`, or the fixed-point data type specified by the other arguments of the function.

`false` indicates that the **Data Type Override** setting is to be ignored.

## Description

This method registers a fixed-point data type with Simulink and returns a data type ID. The data type ID can be used to specify the data types of input and output ports, run-time parameters, and DWork states. It can also be used with all the standard data type access methods defined for instances of this class, such as “DatatypeSize”.

Use this function if you want to register a fixed-point data type by specifying the word length, fractional slope, fixed exponent, and bias. Alternatively, you can use one of the other fixed-point registration functions:

- Use “RegisterDataTypeFxpBinaryPoint” to register a data type with binary point-only scaling.
- Use “RegisterDataTypeFxpSlopeBias” to register a data type with [Slope Bias] scaling.

If the registered data type is not one of the Simulink built-in data types, a Simulink Fixed Point license is checked out.

---

RegisterDataTypeFxpSlopeBias

## Purpose

Register data type with [Slope Bias] scaling.

## Syntax

```
dtID = RegisterDataTypeFxpSlopeBias(isSigned, wordLength,  
totalSlope, bias, obeyDataTypeOverride);
```

## Arguments

isSigned

true if the data type is signed.

false if the data type is unsigned.

wordLength

Total number of bits in the data type, including any sign bit.

totalSlope

Total slope of the scaling of the data type.

bias

Bias of the scaling of the data type.

obeyDataTypeOverride

true indicates that the **Data Type Override** setting for the subsystem is to be obeyed. Depending on the value of **Data Type Override**, the resulting data type could be True Doubles, True Singles, ScaledDouble, or the fixed-point data type specified by the other arguments of the function.

false indicates that the **Data Type Override** setting is to be ignored.

## Description

This method registers a fixed-point data type with Simulink and returns a data type ID. The data type ID can be used to specify the data types of input and output ports, run-time parameters, and DWork states. It can also be used with all the standard data type access methods defined for instances of this class, such as “DatatypeSize” on page 7-124.

# Simulink.MSFcnRunTimeBlock

---

Use this function if you want to register a fixed-point data type with [Slope Bias] scaling. Alternatively, you can use one of the other fixed-point registration functions:

- Use “RegisterDataTypeFxpBinaryPoint” to register a data type with binary point-only scaling.
- Use “RegisterDataTypeFxpFSlopeFixExpBias” to register a data type by specifying the word length, fractional slope, fixed exponent, and bias

If the registered data type is not one of the Simulink built-in data types, a Simulink Fixed Point license is checked out.

---

SetAccelRunOnTLC

## **Purpose**

Specify whether to use block’s TLC file to generate code for the Accelerator mode of Simulink.

## **Syntax**

```
SetAccelRunOnTLC(bVal);
```

## **Arguments**

bVal

May be 'true' (use TLC file) or 'false' (run block in interpreted mode).

## **Description**

Specify if the block should use its TLC file to generate code that runs with the accelerator. If this option is 'false', the block runs in interpreted mode. See the S-function *matlabroot/toolbox/simulink/blocks/msfcn\_times\_two.m* in the Simulink model *msfcndemo\_timestwo.mdl* for an example.

---

SetPreCompInpPortInfoToDynamic

## **Purpose**

Set precompiled attributes of this block’s input ports to be inherited.

## Syntax

```
SetPreCompInpPortInfoToDynamic;
```

## Description

Initialize the compiled information (dimensions, data type, complexity, and sampling mode) of this block's input ports to be inherited. See the S-function *matlabroot/toolbox/simulink/simdemos/adapt\_lms.m* in the Simulink model *sldemo\_msfcn\_lms.mdl* for an example.

---

```
SetPreCompOutPortInfoToDynamic
```

## Purpose

Set precompiled attributes of this block's output ports to be inherited.

## Syntax

```
SetPreCompOutPortInfoToDynamic;
```

## Description

Initialize the compiled information (dimensions, data type, complexity, and sampling mode) of the block's output ports to be inherited. See the S-function *matlabroot/toolbox/simulink/simdemos/adapt\_lms.m* in the Simulink model *sldemo\_msfcn\_lms.mdl* for an example.

---

```
SetSimViewingDevice
```

## Purpose

Specify whether this block is a viewer.

## Syntax

```
SetSimViewingDevice(bVal);
```

## Arguments

bVal

May be 'true' (is a viewer) or 'false' (is not a viewer).

## Description

Specify if the block is a viewer/scope. If this flag is specified, the block will be used only during simulation and automatically stubbed out in generated code.

# Simulink.MSFcnRunTimeBlock

---

---

WriteRTWParam

## **Purpose**

Write a custom parameter to the Real-Time Workshop information file used for code generation.

## **Syntax**

WriteRTWParam(pType, pName, pVal)

## **Arguments**

pType

Type of the parameter to be written. Valid values are 'string' and 'matrix'.

pName

Name of the parameter to be written.

pVal

Value of the parameter to be written.

## **Description**

Use in the WriteRTW method of the M-file S-function to write out custom parameters. These parameters are generally settings used to determine how code should be generated in the TLC file for the S-function. See the S-function *matlabroot/toolbox/simulink/simdemos/adapt\_lms.m* in the Simulink model *sldemo\_msfcn\_lms.mdl* for an example.



**Purpose** Specify data type

**Description** This class lets you specify a data type. To do this,

- 1 Create an instance of this class in the MATLAB base workspace. If you attempt to create a numeric type in a model workspace, Simulink displays an error.
- 2 Set object's properties to the properties of the custom data type
- 3 Assign the data type to all signals and parameters of your model that you want to conform to the data type.

Assigning a data type in this way allows you to change the data types of the signals and parameters in your model by changing the properties of the object that describe them. You do not have to change the model itself.

## Property Dialog Box

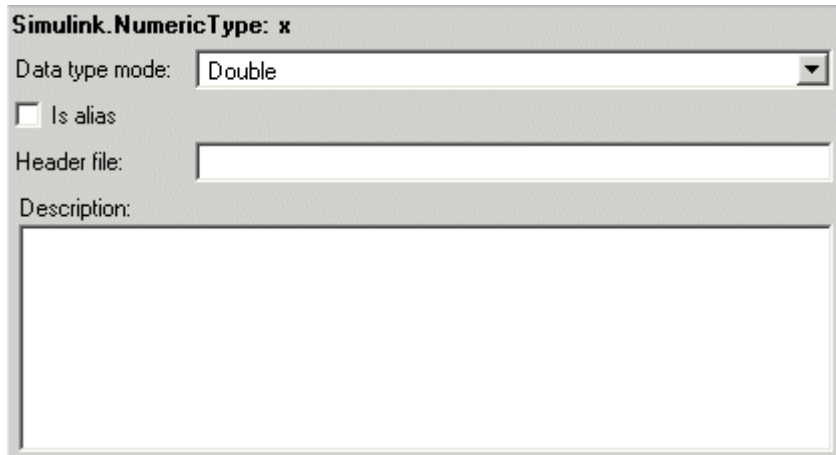

Simulink.NumericType: x

Data type mode: Double

Is alias

Header file:

Description:

### Data type mode

Data type of this numeric type. The options are

# Simulink.NumericType

---

Option	Description
Boolean	Same as the MATLAB boolean type.
Double	Same as the MATLAB double type.
Single	Same as the MATLAB single type.
Fixed-point: unspecified scaling	A fixed-point data type with unspecified scaling.
Fixed-point: binary point scaling	A fixed-point data type with binary-point scaling.
Fixed-point: slope and bias scaling	A fixed-point data type with slope and bias scaling.

Selecting a category causes Simulink to disable other controls on the dialog box (see below) that apply to the category and to disable controls that do not apply. Selecting a fixed-point category may, depending on the other dialog box options that you select, cause the model to run only on systems that have a Simulink Fixed Point option installed.

## Is alias

If this option is selected, Simulink uses the name of the workspace variable that references this object as the name of the data type. Otherwise, Simulink uses the category of the data type as its name, or, if the category is a fixed-point category, Simulink generates a name that encodes the type's properties, using the encoding specified by the Simulink Fixed Point product.

## Header file

Name of a user-supplied C header file that defines a data type having the same name as this numeric type (i.e., as the MATLAB variable that references this object). If this field is not empty, code generated from this model defines the numeric type by including

the specified header file. If this field is empty, the generated code defines the numeric type itself.

## Description

Description of this data type. This field is intended for use in documenting this data type. Simulink ignores it.

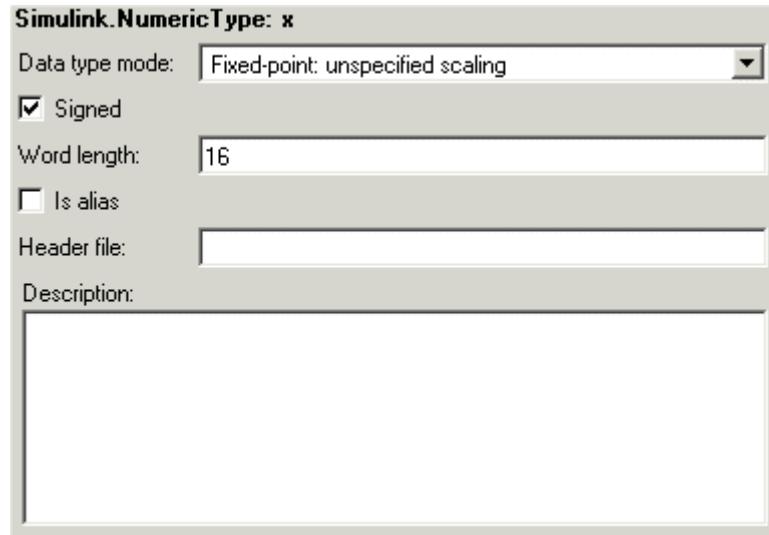

The image shows a configuration dialog box for 'Simulink.NumericType: x'. It contains the following fields and controls:

- Data type mode:** A dropdown menu currently set to 'Fixed-point: unspecified scaling'.
- Signed:** A checked checkbox.
- Word length:** A text input field containing the value '16'.
- Is alias:** An unchecked checkbox.
- Header file:** An empty text input field.
- Description:** A large, empty text area for entering a description.

## Signed

Specifies whether the data type is signed or unsigned. This option is enabled only for fixed-point data type categories.

## Word-Length

Word length in bits of the fixed-point data type. This option is enabled only for fixed-point data type categories.

## Fraction length

Number of bits to the right of the binary point. This option is enabled only if the data type category is Fixed-point: binary point scaling.

# Simulink.NumericType

---

The image shows a configuration dialog box titled "Simulink.NumericType: x". It contains several settings:

- Data type mode:** A dropdown menu set to "Fixed-point: binary point scaling".
- Signed:** A checked checkbox.
- Word length:** A text input field containing the value "16".
- Fraction length:** A text input field containing the value "0".
- Is alias:** An unchecked checkbox.
- Header file:** An empty text input field.
- Description:** A large empty text area.

## **Slope**

Slope for slope and bias scaling. This option is enabled only if the data type category is Fixed-point: slope and bias scaling.

## **Bias**

Bias for slope and bias scaling. This option is enabled only if the data type category is Fixed-point: slope and bias scaling.

**Simulink.NumericType: x**

Data type mode: Fixed-point: slope and bias scaling

Signed

Word length: 16

Slope:  $2^0$

Bias: 0

Is alias

Header file:

Description:

## Properties

Name	Access	Description
Bias	RW	Bias used for slope and bias scaling of a fixed-point data type. This field is intended for use by the Simulink Fixed Point product. (Bias)

# Simulink.NumericType

Name	Access	Description
DataTypeMode	RW	String that specifies the data type of this numeric type. Valid values are 'Double', 'Boolean', 'Single', 'Fixed-point: unspecified scaling', 'Fixed-point: binary point scaling', and 'Fixed-point: slope and bias scaling'. (Data type mode)
Description	RW	Description of this data type. (Description)
FixedExponent	RW	Exponent used for binary point scaling. This property equals -FractionLength. Setting this property causes Simulink to set the FractionLength and Slope properties accordingly, and vice versa. This property applies only if the data type category is Fixed-point: binary point scaling or Fixed-point: slope and bias scaling. It does not appear on the object's Property dialog box, but can be accessed from the MATLAB command prompt.
FractionLength	RW	Integer that specifies the size in bits of the fractional portion of the fixed-point number. This property equals -FixedExponent. Setting this property causes Simulink to set the FixedExponent property accordingly, and vice versa. This field is intended for use by the Simulink Fixed Point product. (Fraction length)
IsAlias	RW	Integer that specifies whether to use the name of this object as the name of the data type that it specifies. Valid values are 1 (yes) or 0 (no). (Is alias)

Name	Access	Description
Signed	RW	Integer that specifies whether this data type is signed or unsigned. Valid values are 1 (yes) or 0 (no). (Signed)
Slope	RW	Slope for slope and bias scaling of fixed-point numbers. This property equals $\text{SlopeAdjustmentFactor} * 2^{\text{FixedExponent}}$ . If $\text{SlopeAdjustmentFactor}$ is 1.0, Simulink displays the value of this field as $2^{\text{SlopeAdjustmentFactor}}$ . Otherwise, it displays it as a numeric value. Setting this property causes Simulink to set the $\text{FixedExponent}$ and $\text{SlopeAdjustmentFactor}$ properties accordingly, and vice versa. This property appears only if $\text{Category}$ is Fixed-point: slope and bias scaling. (Slope)
SlopeAdjustmentFactor	RW	Slope for slope and bias scaling of fixed-point numbers. Setting this property causes Simulink to adjust the $\text{Slope}$ property accordingly, and vice versa. This property applies only if $\text{Category}$ is Fixed-point: slope and bias scaling. It does not appear on the object's Property dialog box, but can be accessed from the MATLAB command prompt.
WordLength	RW	Integer that specifies the word size of this data type. This field is intended for use by the Simulink Fixed Point product. This property appears only if $\text{Category}$ is Fixed-point. (Word Length)

# Simulink.Parameter

---

**Purpose** Specify value, value range, data type, and other properties of block parameter

**Description** This class enables you to create workspace objects that you can then use as the values of block parameters, e.g., the value of a Gain block's Gain parameter. You can create a `Simulink.Parameter` object in the base MATLAB workspace or a model workspace. However, to create the object in a model workspace, you must set the object's storage class to `Auto`.

Parameter objects let you specify not only the value of a parameter but also other information about the parameter, such as the parameter's purpose, its dimensions, its minimum and maximum values, etc. Some Simulink products use this information. For example, Simulink and Real-Time Workshop use information specified by `Simulink.Parameter` objects to determine whether the parameter is tunable (see “Changing the Values of Block Parameters During Simulation” in *Using Simulink*).



## Property Dialog Box

Simulink.Parameter: Param

Value:

Data type:

Dimensions:  Complexity:

Minimum:  Maximum:

Units:

Code generation options

Storage class:

Alias:

Description:

### Value

Value of the parameter. You can use MATLAB expressions to specify the numeric type, dimensions, and data type of the parameter (see “Data Types Supported by Simulink” ). You can also specify fixed-point values for block parameters (see “Specifying Fixed-Point Values Directly” in the Simulink Fixed Point documentation). The following examples illustrate this syntax.

# Simulink.Parameter

---

Expression	Description
<code>single(1.0)</code>	Specifies a single-precision value of 1.0
<code>int8(2)</code>	Specifies an 8-bit integer of value 2
<code>int32(3+2i)</code>	Specifies a complex value whose real and imaginary parts are 32-bit integers
<code>fi(2.3,true,16,3)</code>	Specifies a signed fixed-point numeric object having a value of 2.3, a word length of 16 bits, and a fraction length of 3.

---

**Note** If you specify a typed expression as the parameter object's **Value** property, it overrides the current setting of the **Data type** property.

---

## Data type

Data type of the parameter. You can either select a data type from the adjacent pulldown menu or enter a string. If you select auto (the default), the block that references the parameter object determines the data type of the variable used to represent this parameter in code generated from the model. If you enter a string, it must evaluate to one of the following:

- A built-in data type that Simulink supports (see “Data Types Supported by Simulink” ).
- A `Simulink.NumericType` object
- A `Simulink.AliasType` object

Click the **Show data type assistant** button  to display the **Data Type Assistant**, which helps you set the **Data type** parameter. (See “Using the Data Type Assistant” in *Using Simulink*.)

---

**Note** If you specify a parameter object's data type using the **Data type** property, it overrides any typed expression in the **Value** property and changes the value to be untyped.

---

## **Units**

Measurement units in which this value is expressed, e.g., inches. This field is intended for use in documenting this parameter. Simulink ignores it.

## **Dimensions**

Dimensions of the parameter. Simulink determines the dimensions from the entry in the **Value** field of this parameter. You cannot set this field yourself.

## **Complexity**

Numeric type (i.e., real or complex) of the parameter. Simulink determines the numeric type of this parameter from the entry in the **Value** field of this parameter. You cannot set this field yourself.

## **Minimum**

Minimum value that the parameter can have. Simulink generates a warning if you assign a value to the parameter that is less than the minimum value. When updating the diagram or starting a simulation, Simulink generates an error if the parameter value violates its minimum value.

## **Maximum**

Maximum value that the parameter can have. Simulink generates a warning if you assign a value to the parameter that is greater than the maximum value. When updating the diagram or starting a simulation, Simulink generates an error if the parameter violates its maximum value.

## **Storage class**

Storage class of this parameter. Simulink code generation products use this property to allocate memory for this parameter

# Simulink.Parameter

---

in generate code. See “Tunable Parameter Storage Classes” in *Real-Time Workshop® User’s Guide* for more information.

## Alias

Alternate name for this parameter. Simulink ignores this setting.

## Description

Description of this parameter. This field is intended for use in documenting this parameter. Simulink ignores it.

## Properties

Name	Access	Description
Value	RW	Value of this parameter. (Value)
DataType	RW	String specifying the data type of this parameter. (Data type)
Dimensions	RO	Vector specifying the dimensions of this parameter. (Dimensions)
Complexity	RO	String specifying the numeric type of this parameter. Valid values are 'real' or 'complex'. (Complexity)
Min	RW	Minimum value that this parameter can have. (Minimum)
Max	RW	Maximum value that this parameter can have. (Maximum)
DocUnits	RW	Measurement units in which this parameter’s value is expressed. (Units)

<b>Name</b>	<b>Access</b>	<b>Description</b>
RTWInfo	RW	Information used by Real-Time Workshop for generating code for this parameter. The value of this property is an object of <code>Simulink.ParamRTWInfo</code> class.
Description	RW	String that describes this parameter. This property is intended for user use. Simulink itself does not use it. (Description)

# Simulink.ParamRTWInfo

---

**Purpose** Specify information needed to generate code for parameter

**Description** Simulink creates an instance of this class for each instance of a Simulink.Parameter object that it creates. Simulink uses the Simulink.ParamRTWInfo object to store information needed to generate code for the parameter specified by the Simulink.Parameter object.

You can set the properties of an instance of this class via the RTWInfo property or the property dialog box of the Simulink.Parameter object that uses it. For example, the following MATLAB expression sets the StorageClass property of a Simulink.ParamRTWInfo object used by a parameter object name gain.

```
gain.RTWInfo.StorageClass = 'ExportedGlobal';
```

**Property Dialog Box** Use the Simulink.Parameter property dialog box to set the StorageClass and Alias properties of objects of this class.

## Properties

Name	Description
Alias	Alternate name for this parameter.
CustomAttributes	Custom storage class attributes of this parameter. See “Custom Storage Classes” in the Real-Time Workshop Embedded Coder documentation for more information.
CustomStorageClass	Custom storage class of this parameter.
StorageClass	Storage class of this parameter. See “Tunable Parameter Storage Classes” in the Real-Time Workshop documentation for more information.

**Purpose** Allow Level-2 M-file S-function and other M-file programs to get information about block while simulation is running

**Description** This class allows a Level-2 M-file S-function or other M program to obtain information about a block. Simulink creates an instance of this class or a derived class for each block in a model. Simulink passes the object to the callback methods of Level-2 M-file S-functions when it updates or simulates a model, allowing the callback methods to get block-related information from and provide such information to Simulink. See “Writing Level-2 M-File S-Functions” in Writing S-Functions for more information. You can also use instances of this class in M-file programs to obtain information about blocks during a simulation. See “Accessing Block Data During Simulation” in Using Simulink for more information.

**Parent Class** None

**Derived Classes** Simulink.MSFcnRunTimeBlock

## Property Summary

Name	Description
“BlockHandle”	Block’s handle.
“CurrentTime”	Current simulation time.
“NumDworks”	Number of discrete work vectors used by the block.
“NumOutputPorts”	Number of block output ports.
“NumContStates”	Number of block’s continuous states.
“NumDworkDiscStates”	Number of block’s discrete states
“NumDialogPrms”	Number of parameters that can be entered on S-function block’s dialog box.

# Simulink.RunTimeBlock

---

Name	Description
“NumInputPorts”	Number of block’s input ports.
“NumRuntimePrms”	Number of run-time parameters used by block.
“SampleTimes”	Sample times at which block produces outputs.

## Method Summary

Name	Description
“ContStates”	Get a block’s continuous states.
“DataTypeIsFixedPoint”	Determine whether a data type is fixed point.
“DatatypeName”	Get name of a data type supported by this block.
“DatatypeSize”	Get size of a data type supported by this block.
“Derivatives”	Get a block’s continuous state derivatives.
“DialogPrm”	Get a parameter entered on an S-function block’s dialog box.
“Dwork”	Get one of a block’s Dwork vectors.
“FixedPointNumericType”	Determine the properties of a fixed-point data type.
“InputPort”	Get one of a block’s input ports.
“OutputPort”	Get one of a block’s output ports.
“RuntimePrm”	Get one of the run-time parameters used by a block.



## Properties

---

BlockHandle

**Description**

Block's handle.

**Access**

RO

---

CurrentTime

**Description**

Current simulation time.

**Access**

RO

---

NumDworks

**Description**

Number of data work vectors.

**Access**

RW

**See Also**

ssGetNumDWork

---

NumOutputPorts

**Description**

Number of output ports.

**Access**

RW

**See Also**

ssGetNumOutputPorts

---

NumContStates

**Description**

Number of continuous states.

**Access**

RW

**See Also**

ssGetNumContStates

---

NumDworkDiscStates

**Description**

Number of discrete states. In an M-file S-function, you need to use Dworks to set up discrete states.

**Access**

RW

**See Also**

ssGetNumDiscStates

---

NumDialogPrms

**Description**

Number of parameters declared on the block's dialog. In the case of the S-function, it returns the number of parameters listed as a comma-separated list in the **S-function parameters** dialog field.

**Access**

RW

**See Also**

ssGetNumSFcnParams

---

NumInputPorts

**Description**

Number of input ports.

**Access**

RW

**See Also**

ssGetNumInputPorts

---

NumRuntimePrms

**Description**

Number of run-time parameters used by this block. See “Run-Time Parameters” for more information.

**Access**

RW

**See Also**

ssGetNumSFcnParams

---

SampleTimes

**Description**

Block’s sample times.

**Access**

RW for M-file S-functions, RO for all other blocks.

---

## Methods

ContStates

**Purpose**

Get a block’s continuous states.

**Syntax**

```
states = ContStates();
```

**Description**

Get vector of continuous states.

**See Also**

ssGetContStates

---

DataTypeIsFixedPoint

**Purpose**

Determine whether a data type is fixed point.

**Syntax**

```
bVal = DataTypeIsFixedPoint(dtID);
```

**Arguments**

dtID

Integer value specifying the ID of a data type.

**Description**

Returns true if the specified data type is a fixed-point data type.

---

DatatypeName

**Purpose**

Get the name of a data type.

**Syntax**

```
name = DatatypeName(dtID);
```

**Arguments**

dtID

Integer value specifying ID of a data type.

**Description**

Returns the name of the data type specified by dtID.

**See Also**

“DatatypeSize”

---

DatatypeSize

**Purpose**

Get the size of a data type.

**Syntax**

```
size = DatatypeSize(dtID);
```

## Arguments

dtID

Integer value specifying the ID of a data type.

## Description

Returns the size of the data type specified by dtID.

## See Also

“DatatypeName”

---

Derivatives

## Purpose

Get derivatives of a block’s continuous states.

## Syntax

```
derivs = Derivatives();
```

## Description

Get vector of state derivatives.

## See Also

ssGetdX

---

DialogPrm

**Purpose**

Get an S-function's dialog parameters.

**Syntax**

```
param = DialogPrm(pIdx);
```

**Arguments**

pIdx

Integer value specifying the index of the parameter to be returned.

**Description**

Get the specified dialog parameter. In the case of the S-function, each DialogPrm corresponds to one of the elements in the comma-separated list of parameters in the **S-function parameters** dialog field.

**See Also**

ssGetSFcnParam, "RuntimePrm"

---

Dwork

**Purpose**

Get one of a block's Dwork vectors.

**Syntax**

```
dworkObj = Dwork(dwIdx);
```

**Arguments**

dwIdx

Integer value specifying the index of a work vector.

**Description**

Get information about the Dwork vector specified by dwIdx where dwIdx is the index number of the work vector. This method returns an object of type Simulink.BlockCompDworkData.

**See Also**

ssGetDWork

---

FixedPointNumericType

**Purpose**

Get the properties of a fixed-point data type.

**Syntax**

```
eno = FixedPointNumericType(dtID);
```

**Arguments**

dtID

Integer value specifying the ID of a fixed-point data type.

**Description**

Returns an object of `Embedded.Numeric` class that contains the attributes of the specified fixed-point data type.

---

**Note** `Embedded.Numeric` is also the class of the `numericType` objects created by Fixed-Point Toolbox. For information on the properties defined by `Embedded.Numeric` class, see `numericType Object Properties` in the "Property Reference" in the *Fixed-Point Toolbox User's Guide*.

---

---

InputPort

**Purpose**

Get an input port of a block.

**Syntax**

```
port = InputPort(pIdx);
```

**Arguments**

pIdx

Integer value specifying the index of an input port.

**Description**

Get the input port specified by `pIdx`, where `pIdx` is the index number of the input port. For example,

# Simulink.RunTimeBlock

---

```
port = rto.InputPort(1)
```

returns the first input port of the block represented by the run-time object `rto`.

This method returns an object of type `Simulink.BlockPreComp-InputPortData` or `Simulink.BlockCompInputPortData`, depending on whether the model that contains the port is uncompiled or compiled. You can use this object to get and set the input port's uncompiled or compiled properties, respectively.

### See Also

`ssGetInputPortSignalPtrs`, `Simulink.BlockPreCompInputPortData`, `Simulink.BlockCompInputPortData`, “OutputPort”

---

OutputPort

### Purpose

Get an output port of a block.

### Syntax

```
port = OutputPort(pIdx);
```

### Arguments

`pIdx`

Integer value specifying the index of an output port.

### Description

Get the output port specified by `pIdx`, where `pIdx` is the index number of the output port. For example,

```
port = rto.OutputPort(1)
```

returns the first output port of the block represented by the run-time object `rto`.

This method returns an object of type `Simulink.BlockPreComp-OutputPortData` or `Simulink.BlockCompOutputPortData`, depending on whether the model that contains the port is uncompiled or compiled,



respectively. You can use this object to get and set the output port's uncompiled or compiled properties, respectively.

**See Also**

`ssGetInputPortSignalPtrs`, `Simulink.BlockPreComp-OutputPortData`, `Simulink.BlockCompOutputPortData`

---

`RuntimePrm`

**Purpose**

Get an S-function's run-time parameters.

**Syntax**

```
param = RuntimePrm(pIdx);
```

**Arguments**

`pIdx`

Integer value specifying the index of a run-time parameter.

**Description**

Get the run-time parameter whose index is `pIdx`.

**See Also**

`ssGetRunTimeParamInfo`

# Simulink.ScopeDataLogs

---

**Purpose** Log data displayed by Scope viewer

**Description** Simulink creates instances of this class to log data displayed on Scope viewers (see “Signal & Scope Manager” in Using Simulink). In particular, if you have enabled data logging for a model, Simulink creates an instance of this class for each scope viewer enabled for logging in the model and assigns it to a property of the model’s `Simulink.ModelDataLogs` object. The instance created for each viewer has a `Name` property whose value is the name specified on the History pane of the viewer’s parameter dialog box (see Scope for more information). The instance also has an `axes` property for each of the scope’s axes labeled `Axes1`, `Axes2`, etc. The value of each `axes` property is itself a `Simulink.ScopeDataLogs` object that contains `Simulink.Timeseries` objects, one for each signal displayed on the axes. The time series objects contain the signal data displayed on the axes.

Consider, for example, the following model:

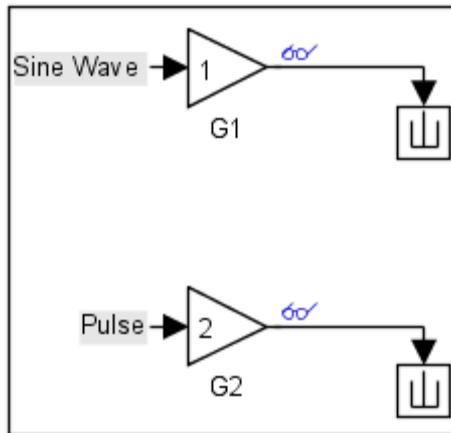

This model displays signals `out1` and `out2` on a scope viewer that has only one set of axes.

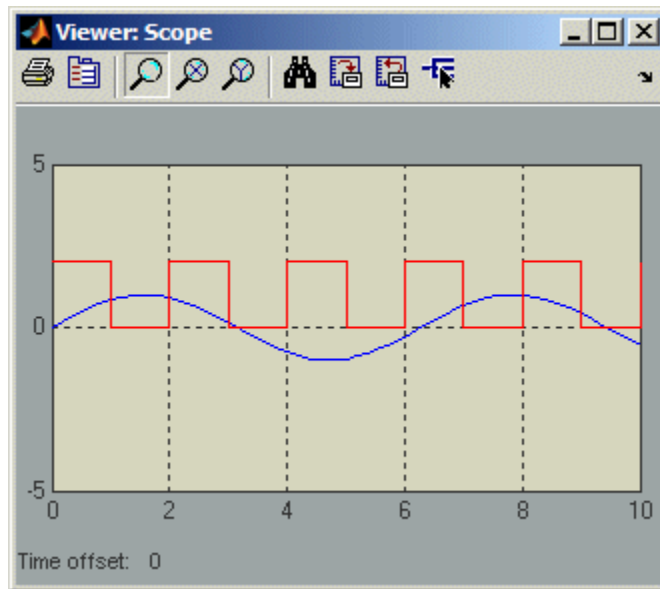

The model enables data logging for the scope viewer under the variable name ScopeData and for the model as a whole under the default variable name logcout.

# Simulink.ScopeDataLogs

---

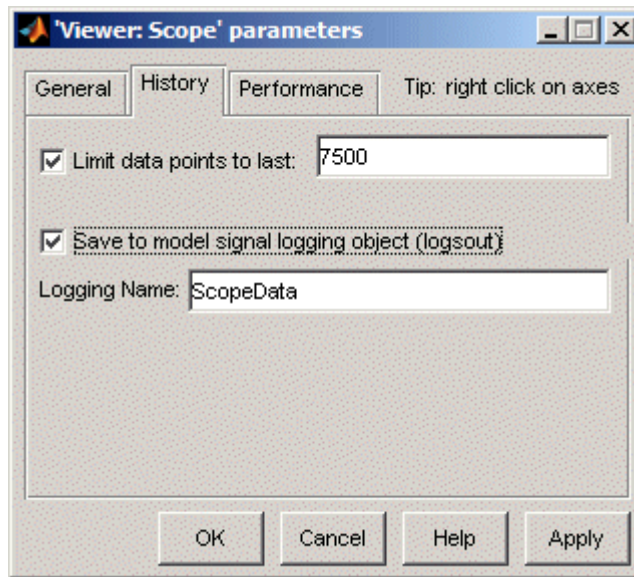

After simulation of the model, the MATLAB workspace contains a `Simulink.ModelDataLogs` object named `logout` containing a `Simulink.ScopeDataLogs` object that in turn contains a `Simulink.ScopeDataLogs` object that contains `Simulink.Timeseries` objects that contain the times series data for signals `out1` and `out 2`.

You can use Simulink data object dot notation to access the data, e.g.,

```
>> logout.ScopeData.axes1
```

```
ans =
```

```
Simulink.ScopeDataLogs (axes1):
```

Name	Elements	Simulink Class
out1	1	Timeseries
out2	1	Timeseries

**Purpose** Specify attributes of signal

**Description** This class enables you to create workspace objects that you can use to specify the attributes that a signal or discrete state should have, for example, its data type, numeric type, dimensions, and so on. You can create a `Simulink.Signal` object in the base MATLAB workspace or a model workspace. However, to create the object in a model workspace, you must set the object's storage class to `Auto`.

Objects of this class allow you to specify the signal or discrete state attributes by giving the signal or discrete state the same name as the workspace variable that references the `Simulink.Signal` object. You can use signal objects both for specifying and checking signal properties.

### **Using Signal Objects to Specify Signal Properties**

You can use signal objects to assign values to properties left unassigned by signal sources, i.e., that are assigned a value of `-1` (inherited) or `auto`. To do this for a particular signal, create a signal object that has the same name as the signal and set the properties of the object that correspond to the properties left unspecified by the signal source.

You can also use a `Signal Specification` block to specify properties left unspecified by a signal source. The advantage of using signal objects is that it allows you to change signal property values without having to edit the model and it simplifies the model's diagram. The advantage of a `Signal Specification` block is that it displays the values assigned to the signal's properties on the block diagram itself.

# Simulink.Signal

The following model illustrates the respective advantages of the two ways of assigning attributes to a signal.

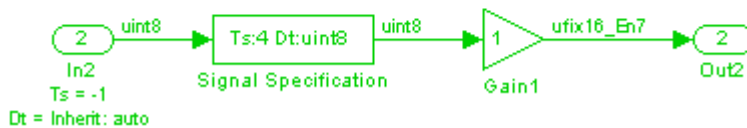
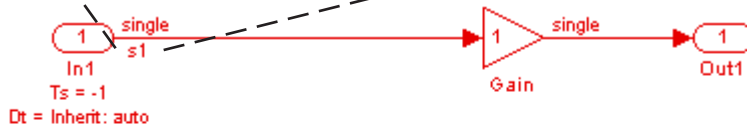
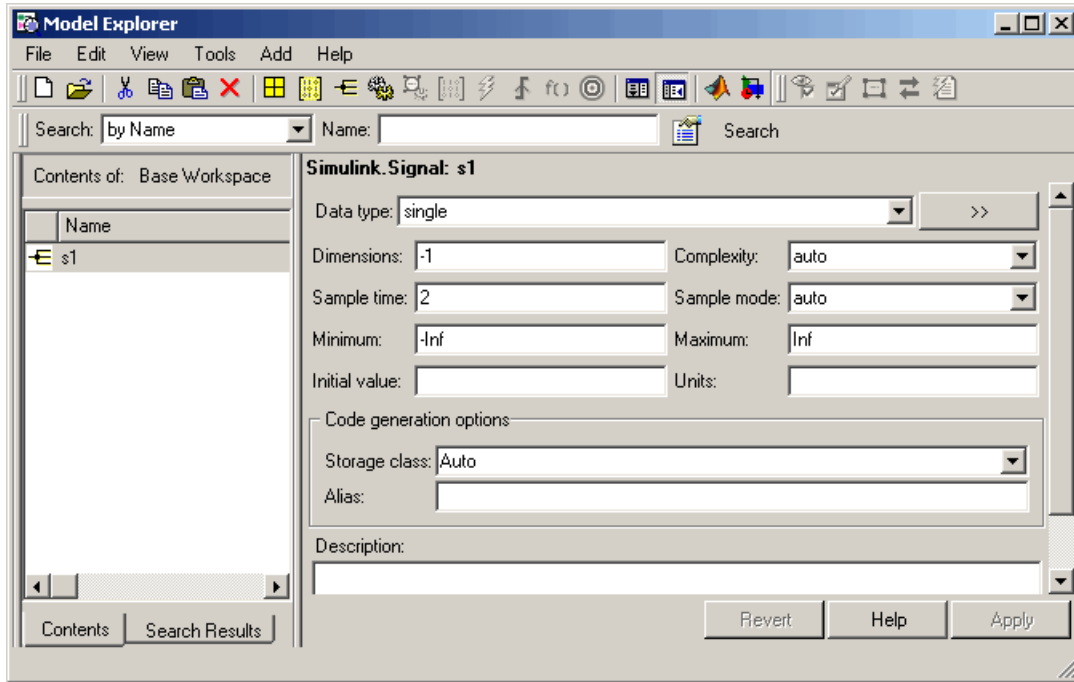

In this example, the signal object named `s1` specifies the sample time and data type of the signal emitted by input port `In1` and a Signal Specification block specifies the sample time and data type of the signal emitted by input port `In2`. As this example illustrates, you have to display the signal object in the Model Explorer to determine many of its properties whereas the Signal Specification block displays the property values on the diagram itself. On the other hand, the use of a signal object to specify the sample time and data type properties of signal `s1` allows you to change the sample time or data type without having to edit the model. For example, you could use the Model Explorer, the MATLAB command line, or an M-file program to change these properties.

## **Using Signal Objects to Check Signal Properties**

You can use signal objects to ensure that signal sources assign desired properties to a signal or state. To do this, create a signal object that has the same name as the signal or state to be validated and that specifies the desired properties. Then, whenever you update the diagram containing the signal or state, Simulink checks the properties of the signal specified by the signal's or state's source against the properties specified by the signal object. For most properties, if the source specifies a value other than inherited or auto for the property and the values specified by the source and the signal object differ, Simulink displays an error message. This enables you to quickly determine whether the actual attributes of your model's signals are the attributes you intend them to have.

## Property Dialog Box

The screenshot shows the 'Simulink.Signal: Sig' property dialog box. It contains several input fields and dropdown menus for configuring signal properties. The 'Data type' field is set to 'auto' and has a '>>' button next to it. Other fields include 'Dimensions' (-1), 'Complexity' (auto), 'Sample time' (-1), 'Sample mode' (auto), 'Minimum' (-Inf), 'Maximum' (Inf), 'Initial value' (empty), and 'Units' (empty). There is a 'Code generation options' section with 'Storage class' (Auto) and 'Alias' (empty). A 'Description' text area is at the bottom. At the very bottom are 'Revert', 'Help', and 'Apply' buttons.

### Data type

Data type of the signal. The default entry, auto, specifies that Simulink should determine the data type. Use the adjacent pulldown list to specify built-in data types (e.g., uint8). To specify a custom data type, enter a MATLAB expression that specifies the type, e.g., a base workspace variable that references a Simulink.NumericType object.

Click the **Show data type assistant** button  to display the **Data Type Assistant**, which helps you set the **Data**



**type** parameter. (See “Using the Data Type Assistant” in *Using Simulink*.)

## **Dimensions**

Dimensions of this signal. Valid values are -1 (the default) specifying any dimensions, N specifying a vector signal of size N, or [M N] specifying an M×N matrix signal.

## **Complexity**

Numeric type of the signal. Valid values are auto (determined by Simulink), real, or complex.

## **Sample time**

Rate at which the value of this signal should be computed. See “Specifying Sample Time” in *Using Simulink* for information on how to specify the sample time.

## **Sample mode**

Sample mode of this signal. Simulink ignores the setting of this field.

## **Minimum**

Minimum value that the signal should have. Simulink uses this value in the following ways:

- When updating the diagram or starting a simulation, Simulink generates an error if the signal’s initial value is less than the minimum value.
- When the **Simulation range checking** diagnostic is enabled, Simulink alerts you during simulation if the signal’s value is less than the minimum value (see “Simulation range checking”).

## **Maximum**

Maximum value that the signal should have. Simulink uses this value in the following ways:

- When updating the diagram or starting a simulation, Simulink generates an error if the signal’s initial value is greater than the maximum value.

- When the **Simulation range checking** diagnostic is enabled, Simulink alerts you during simulation if the signal's value is greater than the maximum value (see “Simulation range checking”).

## Initial value

Signal or state value before a simulation takes its first time step. You can specify any MATLAB string expression that evaluates to a double numeric scalar value or array.

Valid:

```
1.5
[1 2 3]
1+0.5

foo = 1.5;
s1.InitialValue = 'foo';
```

Invalid:

```
uint(1)
foo = '1.5';
s1.InitialValue = 'foo';
```

If necessary, Simulink converts the initial value to ensure type, complexity, and dimension consistency with the corresponding block parameter value. If you specify an invalid value or expression, an error message appears when you update the model.

Initial value settings for signal objects that represent the following signals and states override the corresponding block parameter initial values if undefined (specified as []):

- Output signals of conditionally executed subsystems and Merge blocks
- Block states

## Units

Measurement units in which the value of this signal is expressed, e.g., inches. This field is intended for use in documenting this signal. Simulink ignores it.

## Storage class

Storage class of this signal. See “Tunable Parameter Storage Classes” in the Real-Time Workshop User’s Guide for more information.

## Alias

Alternate name for this signal. Simulink ignores this setting. This property is used for code generation.

## Description

Description of this signal. This field is intended for use in documenting this signal. This property is used by the Simulink Report Generator and for code generation.

## Properties

Name	Access	Description
DataType	RW	String specifying the data type of this signal. (Data type)
Description	RW	Description of this signal. This field is intended for use in documenting this signal. (Description)
Dimensions	RW	Scalar or vector specifying the dimensions of this signal. (Dimensions)
Complexity	RW	String specifying the numeric type of this signal. Valid values are 'auto', 'real', or 'complex'. (Complexity)
Min	RW	Minimum value that this signal can have. (Minimum)
Max	RW	Maximum value that this signal can have. (Maximum)

# Simulink.Signal

---

<b>Name</b>	<b>Access</b>	<b>Description</b>
DocUnits	RW	Measurement units in which this signal's value is expressed. (Units)
RTWInfo	RW	Information used by Real-Time Workshop for generating code for this signal. The value of this property is an object of <code>Simulink.ParamRTWInfo</code> class.
SampleTime	RW	Rate at which this signal should be updated. (Sample time)
Sampling Mode	RW	Sampling mode of this signal. (Sample mode)

## Purpose

Describe element of data structure

## Description

Objects of this class describe elements of structures described by objects of the `Simulink.StructType` class.

## Property Dialog Box

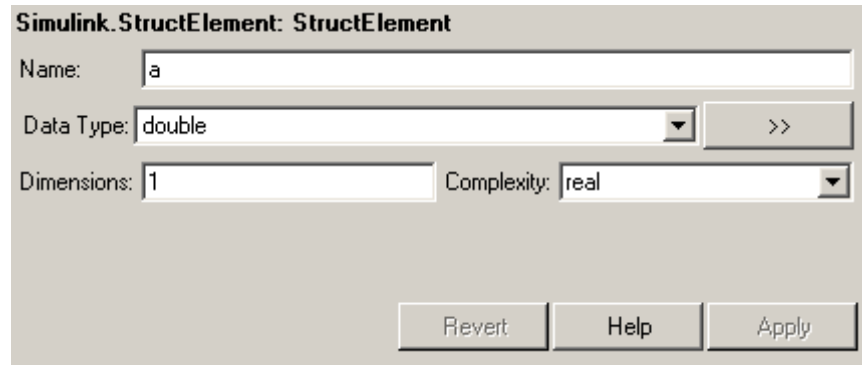

### Name

Specify a name for the element.

### Data type

Specify a data type for this element. You can either select a data type from the adjacent pulldown list or enter a string. If you enter a string, it must evaluate to one of the following:

- A built-in data type supported by Simulink (see “Data Types Supported by Simulink”)
- A `Simulink.NumericType` object
- A `Simulink.AliasType` object

Click the **Show data type assistant** button  to display the **Data Type Assistant**, which helps you set the **Data type** parameter. (See “Using the Data Type Assistant” in *Using Simulink*.)

# Simulink.StructElement

---

## Dimensions

Specify a vector that represents the dimensions of the element.

## Complexity

Specify the numeric type (i.e., real or complex) of this element.

## Properties

Name	Access	Description
Name	RW	String specifying the name of this element. (Name)
DataType	RW	String that specifies the name of the data type of this element. (Data type)
Complexity	RW	String that specifies the numeric type ('real' or 'complex') of this element. (Complexity)
Dimensions	RW	A vector specifying the dimensions of this element. (Dimensions)

## See Also

Simulink.StructType

## Purpose

Describe data structure used as value of signal or parameter

## Description

An object of this class describes a signal whose values are data structures (i.e., aggregates of data of different types as opposed to arrays of values of the same type). This class is intended to support development and use of custom blocks (e.g., S-Function blocks) that accept or output data structures. The class allows users of such blocks to determine the structure of the signals connected to them.

You can use either the Model Explorer or the MATLAB command line to create an instance of this class. You must create structure types in the MATLAB workspace. If you attempt to create a structure type in a model workspace, Simulink displays an error.

To define the elements of a structure, create an array of instances of `Simulink.StructElement` at the MATLAB command line and assign the array as the value of the structure's `Elements` property. For example, the following commands define a structure that contains a floating point and an integer element.

```
v = Simulink.StructElement;
v.Name = 'v';
v.DataType = 'single';
n = Simulink.StructElement;
n.Name = 'n';
n.DataType = 'uint8';

s = Simulink.StructType;
s.Elements = [v n];
```

You can use a structure type object to specify the data type of Inport and Signal Specification blocks. To do this, enter the name of the variable that references the structure type object as the data type in the block's parameter dialog box.

The Simulink S-function API lets you create S-functions capable of generating and manipulating signal structures (see the `simstruc.h` header file for more information). You can connect signal structures

# Simulink.StructType

created by S-function blocks to any standard Simulink block that accepts any data type. This includes virtual blocks and the Switch block configured to require the same data type on all its data inputs.

## Property Dialog Box

**Simulink.StructType: state**

Struct elements

Name	Dimension	Data/Bus Type	Complexity
velocity	1	single	real
roll	1	double	real
pitch	1	double	real
yaw	1	double	real

Header file:

Description:

### Struct elements

Table that displays the properties of the structure's elements. You cannot edit this table. To add or delete this structure's elements or change the properties of elements, you must use MATLAB commands, e.g.,

```
state.Elements(1).DataType = 'double';
```



## Header file

Name of a C header file that declares this structure. This field is intended for use by Real-Time Workshop. Simulink ignores it.

## Description

Description of this structure. This field is intended for you to use to document this structure. Simulink itself does not use this field.

## Properties

Name	Access	Description
Elements	RW	An array of Simulink.StructElement objects that define the names, data types, dimensions, and numeric types of the structure's elements. The elements must have unique names. (Struct elements)
Description	RW	String that describes this structure. This property is intended for user use. Simulink itself does not use it. (Description)
HeaderFile	RW	String that specifies the name of a C header file that declares this structure. (Header file)

## See Also

Simulink.StructElement

# Simulink.SubsysDataLogs

**Purpose** Log signals in subsystem

**Description** Simulink creates instances of this class to contain logs for signals belonging to a subsystem (see “Logging Signals” in Using Simulink). Objects of this class have a variable number of properties. The first property, named Name, is the name of the subsystem whose log data this object contains. The remaining properties are signal log or signal log container objects containing the data logged for the subsystem specified by this object’s Name property.

Consider, for example, the following model.

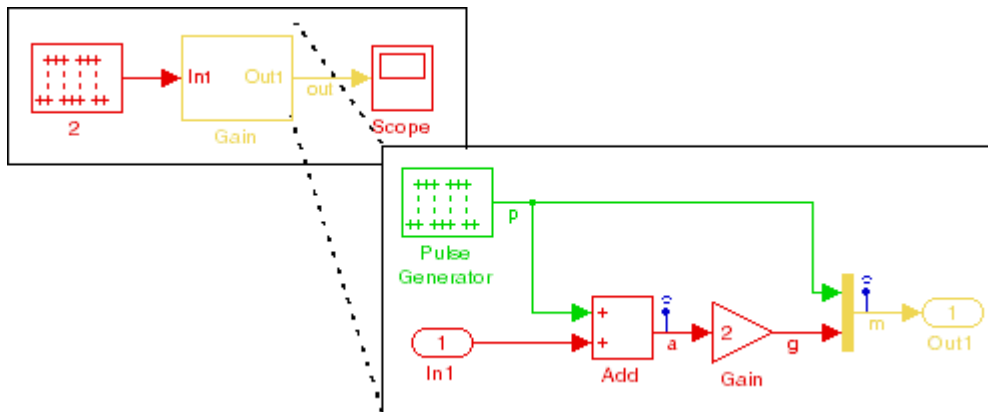

After simulation of this model, the MATLAB workspace contains a Simulink.ModelDataLogs object, named logouts, that contains a Simulink.SubsysDataLogs object, named Gain, that contains the log data for signals a and g in the subsystem named Gain.

```
>> logouts.Gain
```

```
ans =
```

```
Simulink.SubsysDataLogs (Gain):
```

```
    Name          Elements  Simulink Class
```

a	1	Timeseries
g	2	TsArray

You can use either fully qualified log names or the `unpack` command to access the signal logs contained by a `SubsysDataLogs` object. For example, to access the amplitudes logged for signal `a` in the preceding example, you could enter the following at the MATLAB command line:

```
>> data = logouts.Gain.a.Data;
```

or

```
>> logouts.unpack('all');  
data = a.Data;
```

## See Also

`Simulink.ModelDataLogs`, `Simulink.Timeseries`, `Simulink.TsArray`, `unpack`

# Simulink.TimeInfo

---

**Purpose** Provide information about time data in `Simulink.Timeseries` object

**Description** Simulink creates instances of these objects to describe the time data that it includes in `Simulink.Timeseries` objects.

## Properties

Name	Access	Description
Units	RW	The units, e.g., 'seconds', in which the time series data are expressed in the associated <code>Simulink.Timeseries</code> object.
Start	RW	If the associated signal is not in a conditionally executed subsystem, this field contains the simulation time of the first signal value recorded in the associated <code>Simulink.Timeseries</code> object. If the signal is in a conditionally executed subsystem, this field contains an array of times when the system became active.
End	RW	If the associated signal is not in a conditionally executed subsystem, this field contains the simulation time of the last signal value recorded in the associated <code>Simulink.Timeseries</code> object. If the signal is in a conditionally executed subsystem, this field contains an array of times when the system became inactive.

Name	Access	Description
Increment	RW	The interval between simulation times at which signal data is logged in the associated <code>Simulink.Timeseries</code> object. If the signal is aperiodic (continuous signal with variable-step solver), this property has a value of NaN. A signal is periodic if it has a discrete sample time (not continuous or constant) or is continuous with a fixed-step solver.
Length	W	The number of signal samples recorded in the associated <code>Simulink.Timeseries</code> object, i.e., the length of the arrays referenced by the object's <code>Time</code> and <code>Data</code> properties.

## See Also

`Simulink.Timeseries`

# Simulink.Timeseries

---

**Purpose** Log signal data

**Description** Simulink creates instances of this class to store signal data that it logs while simulating a model (see “Logging Signals” in Using Simulink).

---

**Note** The MATLAB Time Series Tools can import and manipulate instances of this class. See Using Time Series Tools in the MATLAB Data Analysis documentation for further details.

---

## Properties

Name	Access	Description
Name	RW	Name of this signal log.
BlockPath	RW	Path of the block that output the signal logged in this signal log.
PortIndex	RW	Index of the output port that emitted the signal logged in this signal log.
SignalName	RW	Name of the signal logged in this signal log.
ParentName	RW	Name of the parent of the signal recorded in this log, if the signal is an element of a composite signal; otherwise, the same as SignalName.
TimeInfo	RW	An object of Simulink.TimeInfo class that describes the time data in this log.
Time	RW	An array containing the simulation times at which signal data was logged.
Data	RW	An array containing the signal data.

**See Also** Simulink.ModelDataLogs, Simulink.TimeInfo, unpack

**Purpose** Log composite virtual signals

**Description** Simulink creates instances of this class to contain the data that it logs for a composite virtual signal, e.g., the output of a Mux or of a virtual Bus Creator block (see “Logging Signals”). Objects of the `Simulink.TsArray` class have a variable number of properties. The first property, called `Name`, specifies the log name of the composite signal. The remaining properties reference logs for the elements of the composite signal, i.e., `Simulink.Timeseries` objects for elementary signals and `Simulink.TSArray` objects for elements that are themselves composite signals, e.g., a bus. The name of each property is the log name of the corresponding signal.

Consider, for example, the following model.

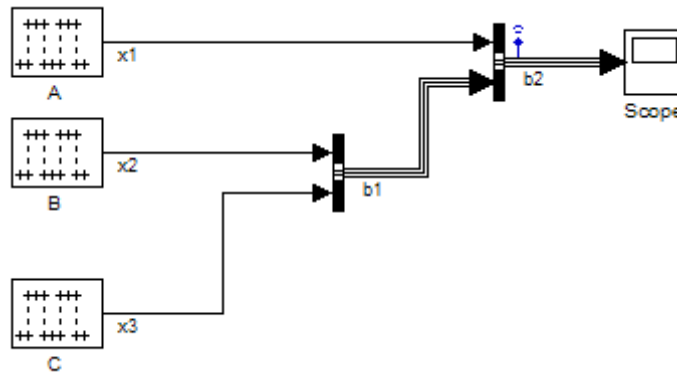

This model specifies that Simulink should log the values of the composite signal `b2` during simulation. After simulation of this model, the MATLAB workspace contains a `Simulink.ModelDataLogs` object, named `logout`, that contains a `Simulink.TsArray` object, named `b2`, that contains the logs for the elements of `b2`, i.e., for the elementary signal `x1` and the bus signal `b1`. Entering the fully qualified name of the `Simulink.TsArray` object, i.e., `logout.b2`, at the MATLAB command line reveals the structure of the signal log for this model.

# Simulink.TsArray

---

```
>> logsout.b2
Simulink.TsArray (untitled/Bus Creator1):
  Name           Elements  Simulink Class
  x1              1        Timeseries
  b1              2        TsArray
```

You can use either fully qualified log names or the `unpack` command to access the signal logs contained by a `Simulink.TsArray` object. For example, to access the amplitudes logged for signal `x1` in the preceding example, you could enter the following at the MATLAB command line:

```
>> data = logsout.b2.x1.Data;
```

or

```
>> logsout.unpack('all');
data = x1.Data;
```

## See Also

`Simulink.ModelDataLogs`, `Simulink.Timeseries`, `unpack`



# Model and Block Parameters

---

Model Parameters (p. 8-2)

Parameters specific to models.

Common Block Parameters (p. 8-66)

Parameters that all blocks have.

Block-Specific Parameters (p. 8-79)

Parameters that a specific block has.

Mask Parameters (p. 8-183)

Parameters of a masked subsystem.

## Model Parameters

### In this section...

“About Model Parameters” on page 8-2

“Examples of Setting Model Parameters” on page 8-65

### About Model Parameters

The following sections list parameters that you can set for Simulink models and blocks, using the `set_param` command.

This table lists and describes parameters that describe a model. The parameters appear in the order they are defined in the model file, as described in Chapter 9, “Model File Format”. The table also includes model callback parameters (see “Using Callback Functions”). The **Description** column indicates where you can set the value on the **Configuration Parameters** dialog box. Examples showing how to change parameters follow the table (see “Examples of Setting Model Parameters” on page 8-65).

Parameter values must be specified as quoted strings. The string contents depend on the parameter and can be numeric (scalar, vector, or matrix), a variable name, a filename, or a particular value. The **Values** column shows the type of value required, the possible values (separated with a vertical line), and the default value, enclosed in braces.

### Model Parameters

Parameter	Description	Values
AbsTol	Absolute error tolerance. Setting for the <b>Absolute tolerance</b> on the <b>Solver</b> pane of the <b>Configuration Parameters</b> dialog box.	string {'auto'}

**Model Parameters (Continued)**

<b>Parameter</b>	<b>Description</b>	<b>Values</b>
AccelVerboseBuild	Determines if Simulink Accelerator displays progress information during code generation.	string {'off'}   'on'
AlgebraicLoopMsg	Specifies diagnostic action to take when there is an algebraic loop. Set by the <b>Algebraic loop</b> option on the <b>Diagnostics</b> pane of the <b>Configuration Parameters</b> dialog box.	'none'   {'warning'}   'error'
AnalyticLinearization	For internal use.	
ArrayBoundsChecking	Setting for the <b>Array bounds exceeded</b> diagnostic on the <b>Diagnostics Data Validity</b> pane of the <b>Configuration Parameters</b> dialog box.	{'none'}   'warning'   'error'
ArtificialAlgebraic-LoopMsg	Setting for the <b>Minimize algebraic loop</b> diagnostic on the <b>Diagnostics</b> pane of the <b>Configuration Parameters</b> dialog box.	'none'   {'warning'}   'error'
AssertControl	See AssertionControl parameter for more information.	
AutoInsertRateTranBlk	Setting for the <b>Automatically handle data transfers between tasks</b> control on the <b>Solver options</b> pane of the <b>Configuration Parameters</b> dialog box.	'on'   {'off'}

**Model Parameters (Continued)**

<b>Parameter</b>	<b>Description</b>	<b>Values</b>
BlockDescription-StringDataTip	Specifies whether to display the user description string for a block as a data tip. Set by the <b>User Description String</b> command on the model editor's <b>View-&gt;Block Data Tips Options</b> menu.	'on'   {'off'}
BlockDiagramType	Type of block diagram (read only).	'model'   'library'
BlockNameDataTip	Specifies whether to display the block name as a data tip. Set by the <b>Block Name</b> command on the model editor's <b>View-&gt;Block Data Tips Options</b> menu.	'on'   {'off'}
BlockParametersDataTip	Specifies whether to display a block's parameter in a data tip. Set by the <b>Parameter Names and Values</b> command on the model editor's <b>View-&gt;Block Data Tips Options</b> menu.	'on'   {'off'}
BlockPriorityViolationMsg	Setting for the <b>Block priority violation</b> diagnostic on the <b>Diagnostics</b> pane of the <b>Configuration Parameters</b> dialog box.	'none'   {'warning'}   'error'
BlockReduction	Enables block reduction optimization. Set by the <b>Block reduction</b> option on the <b>Optimization</b> pane of the <b>Configuration Parameters</b> dialog box.	{'on'}   'off'

**Model Parameters (Continued)**

<b>Parameter</b>	<b>Description</b>	<b>Values</b>
BlockReductionOpt	See BlockReduction parameter for more information.	
Blocks	Names of the blocks that this model contains.	cell array {{{}}
BooleanDataType	Enable Boolean mode. Set by the <b>Implement logic signals as boolean data (vs. double)</b> option on the <b>Optimization</b> pane of the <b>Configuration Parameters</b> dialog box.	{'on'}   'off'
Browser	Deprecated.	
BrowserHandle	Deprecated.	
BrowserLookUnderMasks	Show masked subsystems in the Model Browser. Set by the <b>Show Masked Subsystems</b> command on the model editor's <b>View-&gt;Model Browser Options</b> menu.	'on'   {'off'}
BrowserShowLibraryLinks	Show library links in the Model Browser. Set by the <b>Show Library Links</b> command on the model editor's <b>View-&gt;Model Browser Options</b> menu.	'on'   {'off'}
BusObjectLabelMismatch	Set by the <b>Element name mismatch</b> option on the <b>Connectivity</b> panel of the <b>Diagnostics</b> pane of the <b>Configuration Parameters</b> dialog box.	{'none'}   'warning'   'error'

**Model Parameters (Continued)**

<b>Parameter</b>	<b>Description</b>	<b>Values</b>
BufferReusableBoundary	For internal use.	
BufferReuse	Enable reuse of block I/O buffers. Set by the <b>Reuse block outputs</b> option on the <b>Optimization</b> pane of the <b>Configuration Parameters</b> dialog box.	{ 'on' }   'off'
CheckExecutionContext- RuntimeOutputMsg	Set by the <b>Check runtime output of execution context</b> option on the <b>Compatibility Diagnostics</b> pane of the <b>Configuration Parameters</b> dialog box.	{ 'on' }   'off'
CheckExecutionContext- PreStartOutputMsg	Set by the <b>Check preactivation output of execution context</b> option on the <b>Compatibility Diagnostics</b> pane of the <b>Configuration Parameters</b> dialog box.	{ 'on' }   'off'
CheckForMatrixSingularity	See CheckMatrixSingularityMsg parameter for more information.	
CheckMatrixSingularityMsg	Set by the <b>Division by singular matrix</b> option on the <b>Data Validity</b> pane of the <b>Configuration Parameters</b> dialog box.	{ 'none' }   'warning'   'error'

**Model Parameters (Continued)**

<b>Parameter</b>	<b>Description</b>	<b>Values</b>
CheckModelReference-TargetMessage	Message behavior when the <b>Never rebuild targets diagnostic</b> is set to never in the <b>Model Referencing</b> pane of the <b>Configuration Parameters</b> dialog box.	'none'   'warning'   {'error'}
CheckSSInitialOutputMsg	Enable checking for undefined initial subsystem output. Set by the <b>Check undefined subsystem initial output</b> option on the <b>Compatibility Diagnostics</b> pane of the <b>Configuration Parameters</b> dialog box.	{'on'}   'off'
CloseFcn	Close callback. Created on the <b>Callbacks</b> pane of the Model Properties dialog box. See “Creating Model Callback Functions” in the Using Simulink documentation for further information.	command or variable
ConditionallyExecute-Inputs	Enable conditional input branch execution optimization. Set by the <b>Conditional input branch execution</b> control on the <b>Optimization</b> pane of the <b>Configuration Parameters</b> dialog box.	{'on'}   'off'
ConfigurationManager	Configuration manager for this model.	string {'None'}

**Model Parameters (Continued)**

<b>Parameter</b>	<b>Description</b>	<b>Values</b>
ConsecutiveZCsStepRelTol	Relative tolerance associated with the time difference between zero crossing events. Set by the <b>Consecutive zero crossings relative tolerance</b> option on the <b>Solver</b> pane of the <b>Configuration Parameters</b> dialog box.	string { '10*128*eps' }
ConsistencyChecking	Consistency checking. Set by the <b>Solver data inconsistency</b> option on the <b>Diagnostics</b> pane of the <b>Configuration Parameters</b> dialog box.	{ 'none' }   'warning'   'error'
CovCompData	If CovHTMLOptions is set to off, and CovCumulativeReport is set to on, this parameter specifies cvdata objects containing additional model coverage data to include in the model coverage report. Specified by the <b>Additional data to include in report (cvdata objects)</b> field in the <b>Report</b> pane of the <b>Coverage Settings</b> dialog box.	string



**Model Parameters (Continued)**

Parameter	Description	Values
CovCumulativeReport	<p>If CovHTMLReporting is set to on, this parameter allows the CovCumulativeReport and CovCompData parameters to specify the number of coverage results displayed in the model coverage report.</p> <p>If set to on, display the coverage results for the last simulation in the report.</p> <p>If set to off, display the coverage results from successive simulations in the report. Set by the radial buttons <b>Cumulative runs</b> (on)/<b>Last runs</b> (off) in the <b>Report</b> pane of the <b>Coverage Settings</b> dialog box.</p>	'on'   {'off'}
CovCumulativeVarName	<p>If covSaveCumulativeToWorkspaceVar is set to on, model coverage saves the results of successive simulations in the workspace variable specified by this property. Entered in the field below the selected <b>Save cumulative results in workspace variable</b> check box on the <b>Results</b> pane of the <b>Coverage Settings</b> dialog box.</p>	string {'covCumulativeData'}

## Model Parameters (Continued)

Parameter	Description	Values
CovHTMLOptions	If CovHTMLReporting is set to on, use this parameter to select from a set of display options for the resulting model coverage report. In the <b>Report</b> pane of the <b>Coverage Settings</b> dialog box, select <b>Settings</b> to receive a dialog box for selecting these options.	<p>String of appended character sets separated by a space. HTML options are enabled or disabled through a value of 1 or 0, respectively, in the following character sets (default values shown):</p> <ul style="list-style-type: none"> <li>• ' -aTS=1 ' <p>Include each test in the model summary</p> </li> <li>• ' -bRG=1 ' <p>Produce bar graphs in the model summary</p> </li> <li>• ' -bTC=0 ' <p>Use two color bar graphs (red, blue)</p> </li> <li>• ' -hTR=0 ' <p>Display hit/count ratio in the model summary</p> </li> <li>• ' -nFC=0 ' <p>Do not report fully covered model objects</p> </li> <li>• ' -scm=1 ' <p>Include cyclomatic complexity numbers in summary</p> </li> <li>• ' -bcm=1 ' <p>Include cyclomatic complexity numbers in block details</p> </li> </ul>

## Model Parameters (Continued)

Parameter	Description	Values
CovHtmlReporting	Set to on to tell Simulink to create an HTML report containing the coverage data in the MATLAB Help browser at the end of the simulation. Set by the <b>Generate HTML report</b> check box on the <b>Report</b> pane of the <b>Coverage Settings</b> dialog box.	{ 'on' }   'off'
CovMetricSettings	Selects coverage metrics for coverage report. Coverage metrics are enabled by selecting the check boxes for individual coverages in the <b>Coverage Metrics</b> section of the <b>Coverage</b> pane of the <b>Coverage Settings</b> dialog box. Options 's' and 'w' are enabled by selecting the check boxes <b>Treat Simulink logic blocks as short-circuited</b> and <b>Warn when unsupported blocks exist in model</b> , respectively, in the <b>Options</b> pane of the <b>Coverage Settings</b> dialog box. Option 'e' is disabled by selecting the check box <b>Display coverage results using model coloring</b> in the <b>Results</b> pane of the <b>Coverage Settings</b> dialog box.	string { 'dw' } Each order-independent character in the string enables a coverage metric or option as follows: <ul style="list-style-type: none"> <li>• 'd' Enable decision coverage</li> <li>• 'c' Enable condition coverage</li> <li>• 'm' Enable MCDC coverage</li> <li>• 't' Enable lookup table coverage</li> <li>• 'r' Enable signal range coverage</li> </ul>

**Model Parameters (Continued)**

Parameter	Description	Values
		<ul style="list-style-type: none"> <li>• 's' Treat Simulink logic blocks as short-circuited</li> <li>• 'w' Warn when unsupported blocks exist in model</li> <li>• 'e' Eliminate model coloring for coverage results</li> </ul>
CovNameIncrementing	<p>If CovSaveSingleToWorkspaceVar is set to on, setting this parameter to on tells Model Coverage to increment the workspace variable specified in CovSaveName to store the results succeeding simulations. Entered in the <b>Increment variable name with each simulation</b> check box below the selected <b>Save last run in workspace variable</b> check box on the <b>Results</b> pane of the <b>Coverage Settings</b> dialog box.</p>	'on'   {'off'}

**Model Parameters (Continued)**

<b>Parameter</b>	<b>Description</b>	<b>Values</b>
CovPath	Model path of the subsystem for which Simulink gathers and reports coverage data. Set by browsing for the path in <b>Coverage Instrumentation Path</b> on the <b>Coverage</b> pane of the <b>Coverage Settings</b> dialog box.	string {'/'}
CovReportOnPause	Specifies that when you pause during simulation the model coverage report appears in updated form with coverage results up to the current pause or stop time. Set by selecting the <b>Update results on pause</b> check box on the <b>Results</b> pane of the <b>Coverage Settings</b> dialog box.	{'on'}   'off'
covSaveCumulativeTo-WorkspaceVar	If set to on, causes Model Coverage to accumulate and save the results of successive simulations in the workspace variable in CovCumulativeVarName. Set by selecting the <b>Save cumulative results in workspace variable</b> check box on the <b>Results</b> pane of the <b>Coverage Settings</b> dialog box.	{'on'}   'off'

**Model Parameters (Continued)**

<b>Parameter</b>	<b>Description</b>	<b>Values</b>
CovSaveName	If CovSaveSingleToWorkspaceVar is set to on, Model Coverage saves the results of the last simulation run in the workspace variable specified by this property. Entered in the field below the selected <b>Save last run in workspace variable</b> check box on the <b>Results</b> pane of the <b>Coverage Settings</b> dialog box.	string { 'covdata' }
CovSaveSingleTo-WorkspaceVar	If enabled, tells Model Coverage to save the results of the last simulation run in the workspace variable specified by the CovSaveName property. Set by selecting the <b>Save last run in workspace variable</b> check box on the <b>Results</b> pane of the <b>Coverage Settings</b> dialog box.	{ 'on' }   'off'
Created	Date and time model was created.	string
Creator	Name of model creator.	string { ' ' }
CurrentBlock	For internal use.	
CurrentOutputPort	For internal use.	
DataTypeOverride	Specifies data type used to override fixed-point data types. Set by the <b>Data type override</b> control on the Fixed-Point Tool.	{ 'UseLocalSettings' }   'ScaledDoubles'   'TrueDoubles'   'TrueSingles'   'ForceOff'

**Model Parameters (Continued)**

<b>Parameter</b>	<b>Description</b>	<b>Values</b>
Decimation	Decimation factor. Set by the <b>Decimation</b> field on the <b>Data Import/Export</b> pane of the <b>Configuration Parameters</b> dialog box.	string { '1' }
DeleteChildFcn	Delete child callback.	string { ' ' }
Description	Description of this model. Set by the Description pane of the Model Properties dialog box.	string
Dirty	If the parameter is on, the model has unsaved changes.	'on'   {'off'}
DiscreteInherit-ContinuousMsg	Specifies diagnostic action to take when a Unit Delay block inherits a continuous sample time. Set by the <b>Discrete used as continuous</b> control on the <b>Sample Time Diagnostics</b> pane of the <b>Configuration Parameters</b> dialog box.	'none'   {'warning'}   'error'
DisplayBdSearchResults	For internal use.	
DisplayBlockIO	For internal use.	
DisplayCallgraph-Dominators	For internal use	
DisplayCompileStats	For internal use.	
DisplayCondInputTree	For internal use.	
DisplayCondStIdTree	For internal use.	
DisplayErrorDirections	For internal use.	
DisplayInvisibleSources	For internal use.	
DisplaySortedLists	For internal use.	

**Model Parameters (Continued)**

<b>Parameter</b>	<b>Description</b>	<b>Values</b>
DisplayVectorAnd-FunctionCounts	For internal use.	
DisplayVect-PropagationResults	For internal use.	
Echo	For internal use.	
EnableOverflowDetection	For internal use.	
ExecutionContextIcon	Toggles display of execution context icons on this model's block diagram.	'on'   {'off'}
ExpressionFolding	Enables expression folding. Set by the <b>Eliminate superfluous temporary variables</b> option on the <b>Optimization</b> pane of the <b>Configuration Parameters</b> dialog box.	{'on'}   'off'
ExternalInput	Names of MATLAB workspace variables used to designate data and times to be loaded from the workspace. Set by the <b>Input</b> option on the <b>Data Import/Export</b> pane of the <b>Configuration Parameters</b> dialog box.	scalar or vector {'[t, u]'}
ExtMode...	Parameters whose names start with ExtMode apply to Simulink External Mode. See External Mode in the Real-Time Workshop User's Guide for more information.	



**Model Parameters (Continued)**

<b>Parameter</b>	<b>Description</b>	<b>Values</b>
ExtrapolationOrder	Extrapolation order of the ode14x implicit fixed-step solver. Set by the <b>Extrapolation order</b> control on the <b>Solver</b> pane of the <b>Configuration Parameters</b> dialog box.	1   2   3   {4}
FcnCallInpInside-ContextMsg	Specifies diagnostic action to take when Simulink has to compute any of a function-call subsystem's inputs directly or indirectly during execution of a call to a function-call subsystem. Set by the <b>Context-dependent inputs</b> control on the <b>Connectivity Diagnostics</b> pane of the <b>Configuration Parameters</b> dialog box.	{'Use local settings'}   'Enable All'   'Disable All'
FileName	For internal use.	
FinalStateName	Names of final states to be saved to the workspace. Set by the <b>Final states</b> option on the <b>Data Import/Export</b> pane of the <b>Configuration Parameters</b> dialog box.	string {'xFinal'}
FixedStep	Fixed step size. Set by the <b>Fixed step size (fundamental sample time)</b> field on the <b>Solver</b> pane of the <b>Configuration Parameters</b> dialog box.	string {'auto'}
FixPtInfo	For internal use.	

**Model Parameters (Continued)**

<b>Parameter</b>	<b>Description</b>	<b>Values</b>
FollowLinksWhen-OpeningFromGotoBlocks	Specifies whether to search for Goto tags in libraries referenced by the model when opening the From block dialog box.	'on'   {'off'}
ForceArrayBoundsChecking	For internal use.	
ForceConsistencyChecking	For internal use.	
ForceModelCoverage	For internal use.	
ForwardingTable	Specifies the forwarding table for this library. See “Forwarding Tables” in Using Simulink for more information.	{{ 'old_path_1', 'new_path_1' } ... { 'old_path_n', 'new_path_n' }}
ForwardingTableString	For internal use.	
GridSpacing	Spacing of model editor grid in pixels.	integer {20}
Handle	Handle of this model’s block diagram.	double
s	For internal use.	
HiliteFcnCallInp-InsideContext	Enables highlighting of Function-Call Subsystems when one or more inputs depend on source blocks that appear in their own calling context.	'on'   {'off'}
IgnoreBidirectionalLines	For internal use.	

**Model Parameters (Continued)**

<b>Parameter</b>	<b>Description</b>	<b>Values</b>
InheritedTsInSrcMsg	Message behavior when the sample time is inherited. Set by the <b>Source block specifies -1 sample time</b> control on the <b>Sample Time Diagnostics</b> pane of the <b>Configuration Parameters</b> dialog box.	'none'   {'warning'}   'error'
InitFcn	Function that is called when this model is first compiled for simulation.	string {' '}
InitialState	Initial state name or values. Set by the <b>Initial state</b> field on the <b>Data Import/Export</b> pane of the <b>Configuration Parameters</b> dialog box.	variable or vector {'xInitial'}
InitialStep	Initial step size. Set by the <b>Initial step size</b> field on the <b>Solver</b> pane of the <b>Configuration Parameters</b> dialog box.	string {'auto'}
InlineParams	Enable inline of parameters in generated code. Set by the <b>Inline parameters</b> check box on the <b>Optimization</b> pane of the <b>Configuration Parameters</b> dialog box.	'on'   {'off'}

**Model Parameters (Continued)**

<b>Parameter</b>	<b>Description</b>	<b>Values</b>
InspectSignalLogs	Enable Simulink to display logged signals in the MATLAB <b>Time Series Tools</b> viewer at the end of a simulation or whenever you pause the simulation. Set by the <b>Inspect signal logs when simulation is paused/stopped</b> check box on the <b>Data Import/Export</b> pane of the <b>Configuration Parameters</b> dialog box.	'on'   {'off'}
Int32ToFloatConvMsg	Message behavior when a 32-bit integer is converted to a single-precision float. Set by the <b>32-bit integer to single precision float conversion</b> control on the <b>Type Conversion</b> pane of the <b>Configuration Parameters</b> dialog box.	'none'   {'warning'}
IntegerOverflowMsg	Message behavior when there is an integer overflow. Set by the <b>Data overflow</b> control on the <b>Diagnostics Data Validity</b> pane of the <b>Configuration Parameters</b> dialog box.	'none'   {'warning'}   'error'

## Model Parameters (Continued)

Parameter	Description	Values
InvalidFcnCallConnMsg	Message behavior when there is an invalid function call connection. Set by the <b>Invalid function call connection</b> control on the <b>Connectivity Diagnostics</b> pane of the <b>Configuration Parameters</b> dialog box.	'none'   'warning'   {'error'}
Jacobian	For internal use.	
LastModifiedBy	User name of the person who last modified this model.	string
LastModifiedDate	Date used for version control.	string
LibraryLinkDisplay	Shows which blocks in the model are linked or have disabled or modified links. Set by the <b>Library Link Display</b> option under the <b>Format</b> menu.	{'none'}   'user'   'all'
LibraryType	For internal use.	{'none'}   'BlockLibrary'   'IOLibrary'
LimitDataPoints	Limit output. Set by the <b>Limit data points to last</b> check box on the <b>Data Import/Export</b> pane of the <b>Configuration Parameters</b> dialog box.	{'on'}   'off'
LinearizationMsg	For internal use.	
Lines	For internal use.	
LoadExternalInput	Load input from workspace. Set by the <b>Input</b> check box on the <b>Data Import/Export</b> pane of the <b>Configuration Parameters</b> dialog box.	'on'   {'off'}

**Model Parameters (Continued)**

<b>Parameter</b>	<b>Description</b>	<b>Values</b>
LoadInitialState	Load initial state from workspace. Set by the <b>Initial state</b> check box on the <b>Data Import/Export</b> pane of the <b>Configuration Parameters</b> dialog box.	'on'   {'off'}
Location	For internal use.	
Lock	Lock/unlock a block library. Setting this parameter on prevents a user from inadvertently changing a library.	'on'   {'off'}
MaxConsecutiveMinStep	Maximum number of minimum step size violations allowed during simulation. Set by the <b>Number of consecutive min step size violations allowed</b> control on the <b>Solver</b> pane of the <b>Configuration Parameters</b> dialog box. This option is displayed when the solver option type is Variable-step and the solver is an ode one.	string {'1'}

**Model Parameters (Continued)**

<b>Parameter</b>	<b>Description</b>	<b>Values</b>
MaxConsecutiveZCs	Maximum number of consecutive zero crossings allowed during simulation. Set by the <b>Number of consecutive zero crossings allowed</b> control on the <b>Solver</b> pane of the <b>Configuration Parameters</b> dialog box. This option is displayed when the solver option type is Variable-step and the solver is an ode one.	string {'1000'}
MaxConsecutiveZCsMsg	Specifies diagnostic action to take when Simulink detects the maximum number of consecutive zero crossings allowed. Set by the <b>Consecutive zero crossings violation</b> control on the <b>Diagnostics</b> pane of the <b>Configuration Parameters</b> dialog box. This option is displayed when the solver option type is Variable-step and the solver is an ode one.	'warning'   {'error'}
MaxDataPoints	Maximum number of output data points to save. Set by the <b>Limit data points to last</b> field on the <b>Data Import/Export</b> pane of the <b>Configuration Parameters</b> dialog box.	string {'1000'}

**Model Parameters (Continued)**

<b>Parameter</b>	<b>Description</b>	<b>Values</b>
MaxNumMinSteps	Maximum number of times the solver uses the minimum step size.	string {'-1'}
MaxOrder	Maximum order for ode15s. Set by the <b>Maximum order</b> option on the <b>Solver</b> pane of the <b>Configuration Parameters</b> dialog box.	1   2   3   4   {5}
MaxStep	Maximum step size. Set by the <b>Max step size</b> field on the <b>Solver</b> pane of the <b>Configuration Parameters</b> dialog box.	string {'auto'}
MdlSubVersion	For internal use	
MinMaxOverflowArchiveData	For internal use	
MinMaxOverflowArchiveMode	Logging type for fixed-point logging. Set by the <b>Overwrite or merge results</b> option in the Fixed-Point Tool.	{'Overwrite'}   'Merge'
MinMaxOverflowLogging	Setting for fixed-point logging. Set by the <b>Logging mode</b> option in the Fixed-Point Tool.	{'UseLocalSettings'}   'MinMaxAndOverflow'   'OverflowOnly'   'ForceOff'
MinStep	Minimum step size for the solver. Set by the <b>Min step size</b> field on the <b>Solver</b> pane of the <b>Configuration Parameters</b> dialog box.	string {'auto'}



**Model Parameters (Continued)**

<b>Parameter</b>	<b>Description</b>	<b>Values</b>
MinStepSizeMsg	Message shown when minimum step size is violated. Set by the <b>Min step size violation</b> option on the <b>Diagnostics</b> pane of the <b>Configuration Parameters</b> dialog box.	{'warning'}   'error'
ModelBrowserVisibility	Show the Model Browser. Set by the <b>Model Browser</b> command of the model's <b>View-&gt;Model Browser Options</b> menu.	'on'   {'off'}
ModelBrowserWidth	Width of the Model Browser pane in the model window. To display the Model Browser pane, see the ModelBrowserVisibility parameter.	integer {200}
ModelDataFile	For internal use.	string {' '}
ModelDependencies	List of model dependencies. Set by the <b>Model dependencies</b> field on the <b>Model Referencing</b> pane of the <b>Configuration Parameters</b> dialog box.	string {' '}
ModelReferenceCS-MismatchMessage	Message shown when there is a model configuration mismatch. Set by the <b>Model configuration mismatch</b> option on the <b>Model Referencing Diagnostics</b> pane of the <b>Configuration Parameters</b> dialog box.	{'none'}   'warning'   'error'

**Model Parameters (Continued)**

<b>Parameter</b>	<b>Description</b>	<b>Values</b>
ModelReferenceData-LoggingMessage	Message shown when there is unsupported data logging. Set by the <b>Unsupported data logging</b> option on the <b>Model Referencing Diagnostics</b> pane of the <b>Configuration Parameters</b> dialog box.	'none'   {'warning'}   'error'
ModelReferenceExtr-NoncontSigs	Specifies diagnostic action to take when a discrete signal appears to pass through a Model block to the input of a block with continuous states. Set by the <b>Extraneous discrete derivative signals</b> control on the <b>Diagnostics</b> pane of the <b>Configuration Parameters</b> dialog box.	'none'   'warning'   {'error'}
ModelReferenceIO-MismatchMessage	Message shown when there is a port and parameter mismatch. Set by the <b>Port and parameter mismatch</b> option on the <b>Model Referencing Diagnostics</b> pane of the <b>Configuration Parameters</b> dialog box.	{'none'}   'warning'   'error'
ModelReferenceIOMsg	Message shown when there is an invalid root Inport/Outport block connection. Set by the <b>Invalid root Inport/Outport block connection</b> option on the <b>Model Referencing Diagnostics</b> pane of the <b>Configuration Parameters</b> dialog box.	{'none'}   'warning'   'error'

**Model Parameters (Continued)**

<b>Parameter</b>	<b>Description</b>	<b>Values</b>
ModelReferenceMin- AlgLoopOccurrences	See ModelrefMinAlgLoopOccurrences parameter for more information.	
ModelReferenceNum InstancesAllowed	Total number of instances allowed per top model. Set by the <b>Total number of instances allowed per top model</b> option on the <b>Model Referencing</b> pane of the <b>Configuration Parameters</b> dialog box.	'Zero'   'Single'   {'Multi'}
ModelReferencePass- RootInputsByReference	See ModelrefPassRootInputsByReference parameter for more information.	
ModelReferenceSim- TargetVerbose	Print detailed information when generating simulation targets for models referenced by a top-level model.	'on'   {'off'}
ModelReferenceSymbol- NameMessage	For internal use.	
ModelReferenceTargetType	For internal use.	
ModelReferenceVersion- MismatchMessage	Message shown when there is a model block version mismatch. Set by the <b>Model block version mismatch</b> option on the <b>Model Referencing Diagnostics</b> pane of the <b>Configuration Parameters</b> dialog box.	{'none'}   'warning'   'error'

**Model Parameters (Continued)**

<b>Parameter</b>	<b>Description</b>	<b>Values</b>
ModelrefMinAlgLoop-Occurrences	Toggles the minimization of algebraic loop occurrences. Set by the <b>Minimize algebraic loop occurrences</b> check box on the <b>Model Referencing</b> pane of the <b>Configuration Parameters</b> dialog box.	'on'   {'off'}
ModelrefPassRoot-InputsByReference	Toggles the passing of scalar root inputs by value. Set by the <b>Pass scalar root inputs by value</b> check box on the <b>Model Referencing</b> pane of the <b>Configuration Parameters</b> dialog box.	{'on'}   'off'
ModelVersion	Version number of model.	string {'1.1'}
ModelVersionFormat	Format of model's version number.	string {'1.%.<AutoIncrement:0>'}
ModelWorkspace	References this model's model workspace object.	an instance of the Simulink.ModelWorkspace class
ModifiedBy	Last modifier of this model.	string

**Model Parameters (Continued)**

<b>Parameter</b>	<b>Description</b>	<b>Values</b>
ModifiedByFormat	<p>Format for the display of last modifier. This is set by the <b>Last saved by</b> parameter on the History pane of the Model Properties dialog box. See “Model History Controls” in the Using Simulink documentation for further information.</p> <p>This can also be set by the <b>Last saved by</b> on the <b>Model history</b> field on the <b>History</b> pane of the <b>Model Explorer</b> dialog box.</p>	string { '%<Auto>' }
ModifiedComment	Field for user comments.	string { '' }
ModifiedDate	Date of last model modification.	string
ModifiedDateFormat	Format of modified date.	string { '%<Auto>' }

**Model Parameters (Continued)**

<b>Parameter</b>	<b>Description</b>	<b>Values</b>
ModifiedHistory	<p>Area for keeping notes about the history of the model. This is set by the History pane of the Model Properties dialog box. See “Model History Controls” in <i>Using Simulink</i> the Using Simulink documentation for further information.</p> <p>This can also be set by the <b>Model history</b> field on the <b>History</b> pane of the <b>Model Explorer</b> dialog box.</p>	string { ' ' }
MultiTaskDSMMsg	<p>Specifies diagnostic action to take when one task reads data from a Data Store Memory block to which another task writes data. Set by the <b>Multitask data store</b> control on the <b>Diagnostics Data Validity</b> pane of the <b>Configuration Parameters</b> dialog box.</p>	'none'   {'warning'}   'error'
MultiTaskRateTransMsg	<p>Specifies diagnostic action to take when an invalid rate transition takes place between two blocks operating in single-tasking mode. Set by the <b>Multitask rate transition</b> control on the <b>Sample Time Diagnostics</b> pane of the <b>Configuration Parameters</b> dialog box.</p>	'warning'   {'error'}
Name	Model name.	string

**Model Parameters (Continued)**

<b>Parameter</b>	<b>Description</b>	<b>Values</b>
NumberNewtonIterations	Number of Newton's Method iterations performed by the ode14x implicit fixed-step solver. Set by the <b>Number Newton's iterations</b> control on the <b>Solver</b> pane of the <b>Configuration Parameters</b> dialog box.	integer {1}
ObjectParameters	Names/attributes of model parameters.	structure
Open	For internal use.	
OptimizeBlockIOStorage	Enables signal storage reuse optimization. Set by the <b>Signal storage reuse</b> control on the <b>Optimization</b> pane of the <b>Configuration Parameters</b> dialog box.	{'on'}   {'off'}
OutputOption	Time step output options for variable-step solvers. Set by the <b>Output options</b> option on the <b>Data Import/Export</b> pane of the <b>Configuration Parameters</b> dialog box.	'AdditionalOutputTimes'   {'RefineOutputTimes'}   'SpecifiedOutputTimes'
OutputSaveName	Workspace variable to store the model outputs. Set by the <b>Output</b> field on the <b>Data Import/Export</b> pane of the <b>Configuration Parameters</b> dialog box.	variable {'yout'}

**Model Parameters (Continued)**

<b>Parameter</b>	<b>Description</b>	<b>Values</b>
OutputTimes	Output times set when <b>Output options</b> on the <b>Data Import/Export</b> pane of the <b>Configuration Parameters</b> dialog box is set to <b>Produce additional output</b> . Set by the <b>Output times</b> option on the <b>Data Import/Export</b> pane of the <b>Configuration Parameters</b> dialog box.	string {'[]'}
PaperOrientation	Printing paper orientation.	'portrait'   {'landscape'}   'rotated'
PaperPosition	When PaperPositionMode is set to manual, this parameter determines the position and size of a diagram on paper and the size of the diagram exported as a graphic file in the units specified by PaperUnits.	[left, bottom, width, height]



**Model Parameters (Continued)**

Parameter	Description	Values
PaperPositionMode	<p>Paper position mode.</p> <ul style="list-style-type: none"> <li>• auto When printing, Simulink sizes the diagram to fit the printed page. When exporting a diagram as a graphic image, Simulink sizes the exported image to be the same size as the diagram's normal size on screen.</li> <li>• manual When printing, Simulink positions and sizes the diagram on the page as indicated by PaperPosition. When exporting a diagram as a graphic image, Simulink sizes the exported graphic to have the height and width specified by PaperPosition.</li> <li>• tiled Enables tiled printing. See "Tiled Printing" for more information.</li> </ul>	{'auto'}   'manual'   'tiled'
PaperSize	Size of PaperType in PaperUnits.	[width height] (read only)

**Model Parameters (Continued)**

Parameter	Description	Values
PaperType	Printing paper type.	'usletter'   'uslegal'   'a0'   'a1'   'a2'   'a3'   'a4'   'a5'   'b0'   'b1'   'b2'   'b3'   'b4'   'b5'   'arch-A'   'arch-B'   'arch-C'   'arch-D'   'arch-E'   'A'   'B'   'C'   'D'   'E'   'tabloid'
PaperUnits	Printing paper size units.	'normalized'   {'inches'}   'centimeters'   'points'
ParameterArgumentNames	List of parameters used as arguments when this model is called as a reference. Set in the <b>Model arguments (for referencing this model)</b> field in the <b>Model Workspace</b> pane of the <b>Model Explorer</b> .	string { ' ' }
ParameterDowncastMsg	Specifies diagnostic action to take when a parameter downcast occurs during simulation. Set by the <b>Detect downcast</b> control on the <b>Diagnostics Data Validity</b> pane of the <b>Configuration Parameters</b> dialog box.	'none'   'warning'   { 'error' }

**Model Parameters (Continued)**

<b>Parameter</b>	<b>Description</b>	<b>Values</b>
ParameterOverflowMsg	Specifies diagnostic action to take when a parameter overflow occurs during simulation. Set by the <b>Detect overflow</b> control on the <b>Diagnostics Data Validity</b> pane of the <b>Configuration Parameters</b> dialog box.	'none'   'warning'   {'error'}
ParameterPrecisionLossMsg	Specifies diagnostic action to take when parameter precision loss occurs during simulation. Set by the <b>Detect precision loss</b> control on the <b>Diagnostics Data Validity</b> pane of the <b>Configuration Parameters</b> dialog box.	'none'   {'warning'}   'error'
ParameterTunabilityLossMsg	Specifies diagnostic action to take when a parameter cannot be tuned because it uses unsupported functions or operators. Set by the <b>Detect loss of tunability</b> control on the <b>Diagnostics Data Validity</b> pane of the <b>Configuration Parameters</b> dialog box.	'none'   {'warning'}   'error'
ParameterUnderflowMsg	Specifies diagnostic action to take when a parameter underflow occurs during simulation. Set by the <b>Detect underflow</b> control on the <b>Diagnostics Data Validity</b> pane of the <b>Configuration Parameters</b> dialog box.	{'none'}   'warning'   'error'

**Model Parameters (Continued)**

<b>Parameter</b>	<b>Description</b>	<b>Values</b>
ParamWorkspaceSource	For internal use.	
Parent	Name of the model or subsystem that owns this object. The value of this parameter for a model is an empty string.	string { ' ' }
PositivePriorityOrder	Choose the appropriate priority ordering for the real-time system targeted by this model. The Real-Time Workshop uses this information to implement asynchronous data transfers. Set by <b>Configuration Parameters &gt; Solver &gt; Solver Options &gt; Higher priority value indicates higher task priority.</b>	'on'   {'off'}
PostLoadFcn	Function invoked just after this model is loaded. Created on the <b>Callbacks</b> pane of the Model Properties dialog box. See “Creating Model Callback Functions” in the Using Simulink documentation for further information.	string { ' ' }
PostSaveFcn	Function invoked just after this model is saved to disk.	string { ' ' }

**Model Parameters (Continued)**

<b>Parameter</b>	<b>Description</b>	<b>Values</b>
PreLoadFcn	Preload callback. Created on the <b>Callbacks</b> pane of the Model Properties dialog box. See “Creating Model Callback Functions” in the Using Simulink documentation for further information.	command or variable { '' }
PreSaveFcn	Function invoked just before this model is saved to disk. Created on the <b>Callbacks</b> pane of the Model Properties dialog box. See “Creating Model Callback Functions” in the Using Simulink documentation for further information.	string { '' }
ProdBitPerChar	Specifies the length in bits of the C char data type supported by the production hardware device type targeted by this model. Set by the <b>char</b> control in the <b>Embedded Hardware Implementation</b> pane of the <b>Configuration Parameters</b> dialog box.	integer {8}

**Model Parameters (Continued)**

<b>Parameter</b>	<b>Description</b>	<b>Values</b>
ProdBitPerInt	Specifies the length in bits of the C int data type supported by the production hardware device type targeted by this model. Set by the <b>int</b> control in the <b>Embedded Hardware Implementation</b> pane of the <b>Configuration Parameters</b> dialog box.	integer {32}
ProdBitPerLong	Specifies the length in bits of the C long data type supported by the production hardware device type targeted by this model. Set by the <b>long</b> control in the <b>Embedded Hardware Implementation</b> pane of the <b>Configuration Parameters</b> dialog box.	integer {32}
ProdBitPerShort	Specifies the length in bits of the C short data type supported by the production hardware device type targeted by this model. Set by the <b>short</b> control in the <b>Embedded Hardware Implementation</b> pane of the <b>Configuration Parameters</b> dialog box.	integer {16}

**Model Parameters (Continued)**

<b>Parameter</b>	<b>Description</b>	<b>Values</b>
ProdEndianess	Specifies the significance of the first byte of a data word of the target hardware. Set by the <b>Byte ordering</b> control in the <b>Embedded Hardware Implementation</b> pane of the <b>Configuration Parameters</b> dialog box.	{ 'Unspecified' }   'LittleEndian'   'BigEndian'
ProdEqTarget	Specifies that the hardware used to test the code generated from this model is the same as the production hardware or has the same characteristics. Set by the <b>None</b> control in the <b>Emulation Hardware Implementation</b> pane of the <b>Configuration Parameters</b> dialog box.	{ 'on' }   'off'
ProdHWDeviceType	Predefined hardware device to specify the C language constraints for your microprocessor. Set by the <b>Device type</b> option on the <b>Hardware Implementation</b> pane of the <b>Configuration Parameters</b> dialog box.	string { '32-bit Generic' }
ProdHWWordLengths	Number of bits used for char, short, int, and long, respectively (set by the hardware device type).	string { '8, 16, 32, 32' }

**Model Parameters (Continued)**

Parameter	Description	Values
ProdIntDivRoundTo	Specifies how an ANSI C conforming compiler used to compile code for the production hardware targeted by this model rounds the result of dividing one signed integer by another to produce a signed integer quotient. Set by the <b>Signed integer division rounds to</b> control in the <b>Embedded Hardware</b> panel of the <b>Hardware Implementation</b> pane of the <b>Configuration Parameters</b> dialog box.	'Floor'   'Zero'   {'Undefined'}
ProdShiftRightIntArith	Specifies whether the C compiler implements a signed integer right shift as an arithmetic right shift. Set by the <b>Shift right on a signed integer as arithmetic shift</b> control in the <b>Embedded Hardware</b> panel of the <b>Hardware Implementation</b> pane of the <b>Configuration Parameters</b> dialog box.	{'on'}   'off'



**Model Parameters (Continued)**

<b>Parameter</b>	<b>Description</b>	<b>Values</b>
ProdWordSize	Specifies the word length in bits of the production hardware device type targeted by this model. Set by the <b>native word size</b> control in the <b>Embedded Hardware</b> panel of the <b>Hardware Implementation</b> pane of the <b>Configuration Parameters</b> dialog box.	integer {32}
Profile	Enables the simulation profiler for this model.	'on'   {'off'}
ReadBeforeWriteMsg	Specifies diagnostic action to take when the model attempts to read data from a data store before it has stored data at the current time step. Set by the <b>Detect read before write</b> control on the <b>Diagnostics Data Validity</b> pane of the <b>Configuration Parameters</b> dialog box.	{'UseLocalSettings'}   'DisableAll'   'EnableAllAsWarning'   'EnableAllAsError'

**Model Parameters (Continued)**

Parameter	Description	Values
RecordCoverage	<p>A value of on causes Simulink to gather and report model coverage data during simulation. The format of this report is controlled by the values of the following parameters:</p> <ul style="list-style-type: none"> <li>CovCompData</li> <li>CovCumulativeReport</li> <li>CovCumulativeVarName</li> <li>CovHTMLOptions</li> <li>CovHTMLReporting</li> <li>CovMetricSettings</li> <li>CovNameIncrementing</li> <li>CovPath</li> <li>CovReportOnPause</li> <li>covSaveCumulativeToWorkSpaceVar</li> <li>CovSaveName</li> <li>CovSaveSingleToWorkspaceVar</li> </ul> <p>If the value is off, no model coverage data is collected or reported and the preceding coverage report parameters have no effect.</p>	'on'   {'off'}

**Model Parameters (Continued)**

<b>Parameter</b>	<b>Description</b>	<b>Values</b>
Refine	Refine factor. Set by the <b>Refine factor</b> field on the <b>Data Import/Export</b> pane of the <b>Configuration Parameters</b> dialog box.	string {'1'}
RelTol	Relative error tolerance. Set by the <b>Relative tolerance</b> field on the <b>Solver</b> pane of the <b>Configuration Parameters</b> dialog box.	string {'1e-3'}
ReportName	Name of the associated file for the Report Generator	string {'simulink-default.rpt'}
ReqHilite	Highlights all the blocks in the Simulink diagram that have requirements associated with them. Set by the <b>Highlight model</b> command on the <b>Tools-&gt;Requirements</b> menu.	'on'   {'off'}
RequirementInfo	For internal use.	
RootOutportRequire- BusObject	Specifies diagnostic action to take when a bus enters a root model Outport block for which a bus object has not been specified. Set by the <b>Unspecified bus object at root Outport block</b> control on the <b>Connectivity Diagnostics</b> pane of the <b>Configuration Parameters</b> dialog box.	'none'   {'warning'}   'error'

**Model Parameters (Continued)**

<b>Parameter</b>	<b>Description</b>	<b>Values</b>
RTPrefix	Specifies diagnostic action to take when Simulink encounters an object name that begins with <code>rt</code> . Set by the <b>"rt" prefix for identifiers</b> control on the <b>Diagnostics Data Validity</b> pane of the <b>Configuration Parameters</b> dialog box.	'none'   'warning'   {'error'}
RTW...	See the Real-Time Workshop documentation for more information on parameters whose names begin with RTW.	
SampleTimeColors	Set by the Sample Time Colors option under the <b>Format &gt; Port/Signal Displays</b> menu.	'on'   {'off'}
SampleTimeConstraint	Set by the Periodic Sample Time Constraint option on the <b>Configuration Parameters</b> dialog box. This option is displayed when the solver option type is Fixed-step	{'unconstrained'}   'STIndependent'   'Specified'
SampleTimeProperty	Specifies and assigns priorities to the sample times implemented by the model. Set by the <b>Sample time properties</b> option on the <b>Solver</b> pane of the <b>Configuration Parameters</b> dialog box. This option is displayed when the Periodic sample time constraint is set to Specified.	Structure containing the fields SampleTime, Offset, and Priority.

**Model Parameters (Continued)**

<b>Parameter</b>	<b>Description</b>	<b>Values</b>
SaveCharacterEncoding	Specifies the character set used to encode this model. See the <code>slCharacterEncoding</code> command for more information.	string
SaveDefaultBlockParams	For internal use.	
SaveFinalState	Save final states to workspace. Set by the <b>Final states</b> check box on the <b>Data Import/Export</b> pane of the <b>Configuration Parameters</b> dialog box.	'on'   {'off'}
SaveFormat	Format used to save data to the MATLAB workspace. Set by the <b>Format</b> option on the <b>Data Import/Export</b> pane of the <b>Configuration Parameters</b> dialog box.	{'Array'}   'Structure'   'StructureWithTime'
SaveOutput	Save simulation output to workspace. Set by the <b>Output</b> check box on the <b>Data Import/Export</b> pane of the <b>Configuration Parameters</b> dialog box.	{'on'}   'off'
SaveState	Save states to workspace. Set by the <b>States</b> check box on the <b>Data Import/Export</b> pane of the <b>Configuration Parameters</b> dialog box.	'on'   {'off'}

**Model Parameters (Continued)**

<b>Parameter</b>	<b>Description</b>	<b>Values</b>
SaveTime	Save simulation time to workspace. Set by the <b>Time</b> check box on the <b>Data Import/Export</b> pane of the <b>Configuration Parameters</b> dialog box.	{'on'}   'off'
SaveWithDisabledLinksMsg	Specifies diagnostic action to take when saving a block diagram having disabled library links	'none'   {'warning'}   'error'
SaveWithParameterized-LinksMsg	Specifies diagnostic action to take when saving a block diagram having parameterized library links	'none'   {'warning'}   'error'
ScreenColor	Background color of the model window. Set by the Screen color option under the <b>Format</b> menu.	'black'   {'white'}   'red'   'green'   'blue'   'cyan'   'magenta'   'yellow'   'gray'   'lightBlue'   'orange'   'darkGreen'   [r,g,b,a] where r, g, b, and a are the red, green, blue, and alpha values of the color normalized to the range 0.0 to 1.0. The alpha value is ignored.
ScrollbarOffset	For internal use.	
SFcnCompatibilityMsg	See SfunCompatibilityCheckMsg parameter for more information.	

**Model Parameters (Continued)**

<b>Parameter</b>	<b>Description</b>	<b>Values</b>
SfunCompatibilityCheckMsg	Specifies diagnostic action to take when S-function upgrades are needed. Set by the <b>S-function upgrades needed</b> option on the <b>Compatibility Diagnostics</b> pane of the <b>Configuration Parameters</b> dialog box.	{'none'}   'warning'   'error'
ShowGrid	Show the Model Editor grid.	'on'   {'off'}
ShowLinearization-Annotations	Toggles linearization icons in the model.	{'on'}   'off'
ShowLineDimensions	Show signal dimensions on this model's block diagram. Set by the <b>Signal Dimensions</b> command on the <b>Format-&gt;Port/Signal Displays</b> menu.	'on'   {'off'}
ShowLineDimensionsOnError	For internal use.	
ShowLineWidths	Deprecated. Use ShowLineDimensions instead.	
ShowLoopsOnError	Highlight invalid loops graphically.	{'on'}   'off'
ShowModelReferenceBlockIO	Toggles display of I/O mismatch on block. Set by the <b>Model Block I/O Mismatch</b> item on the <b>Format-&gt;Block Displays</b> menu.	'on'   {'off'}
ShowModelReference-BlockVersion	Toggles display of version on block. Set by the <b>Model Block Version</b> item on the <b>Format-&gt;Block Displays</b> menu.	'on'   {'off'}

**Model Parameters (Continued)**

<b>Parameter</b>	<b>Description</b>	<b>Values</b>
Shown	For internal use.	
ShowPageBoundaries	Toggles display of page boundaries on the Model Editor's canvas. Set by the <b>Show Page Boundaries</b> command on the Model Editor's <b>View</b> menu.	'on'   {'off'}
ShowPortDataTypes	Show data types of ports on this model's block diagram. Set by the <b>Port Data Types</b> command on the <b>Format-&gt;Port/Signal Displays</b> menu.	'on'   {'off'}
ShowPortDataTypesOnError	For internal use.	
ShowStorageClass	Show storage classes of signals on this model's block diagram. Set by the <b>Storage Class</b> command on the <b>Format-&gt;Port/Signal Displays</b> menu.	'on'   {'off'}
ShowTestPointIcons	Show test point icons on this model's block diagram. Set by the <b>Testpoint Indicators</b> command on the <b>Format-&gt;Port/Signal Displays</b> menu.	'on'   {'off'}
ShowViewerIcons	Show viewer icons on this model's block diagram. Set by the <b>Viewer Indicators</b> command on the <b>Format-&gt;Port/Signal Displays</b> menu.	'on'   {'off'}



**Model Parameters (Continued)**

<b>Parameter</b>	<b>Description</b>	<b>Values</b>
SignalInfNanChecking	Specifies diagnostic action to take when the value of a block output is Inf or NaN at the current time step. Set by the <b>Inf or NaN block output</b> option on the <b>Diagnostics Data Validity</b> pane of the <b>Configuration Parameters</b> dialog box.	{'none'}   'warning'   'error'
SignalLabelMismatchMsg	Specifies diagnostic action to take when there is a signal label mismatch. Set by the <b>Signal label mismatch</b> option on the <b>Connectivity Diagnostics</b> pane of the <b>Configuration Parameters</b> dialog box.	{'none'}   'warning'   'error'
SignalLogging	Globally enable signal logging for this model. Set by the <b>Signal logging</b> check box on the <b>Data Import/Export</b> pane of the <b>Configuration Parameters</b> dialog box.	{'on'}   'off'
SignalLoggingName	Name for saving signal logging data to the MATLAB workspace. Set by the <b>Signal logging</b> field on the <b>Data Import/Export</b> pane of the <b>Configuration Parameters</b> dialog box.	string {'logsOut'}

**Model Parameters (Continued)**

<b>Parameter</b>	<b>Description</b>	<b>Values</b>
SignalResolutionControl	Control which named states and signals get resolved to Simulink signal objects. Set by the <b>Signal resolution</b> drop-down list on the <b>Diagnostics Data Validity</b> pane of the <b>Configuration Parameters</b> dialog box.	{'UseLocalSettings'}   'TryResolveAll'   'TryResolveAll-WithWarning'
SigSpecEnsureSample-TimeMsg	Specifies diagnostic action to take when the sample time of the source port of a signal specified by a Signal Specification block differs from the signal's destination port. Set by the <b>Enforce sample times specified by Signal Specification blocks</b> control on the <b>Sample Time Diagnostics</b> pane of the <b>Configuration Parameters</b> dialog box.	'none'   {'warning'}   'error'
SimCompilerOptimization	Specifies the compiler optimization level during acceleration code generation	string {'off'}   'on'

## Model Parameters (Continued)

Parameter	Description	Values
SimulationCommand	Executes a simulation command.  <b>Note</b> You cannot use <code>set_param</code> to run a simulation in a MATLAB session that does not have a display, i.e., if you used <code>matlab -nodisplay</code> to start the session.	'start'   'stop'   'pause'   'continue'   'step'   'update'   'WriteDataLogs'   'SimParamDialog'   'connect'   'disconnect'   'WriteExtModeParamVect'   'AccelBuild'
SimulationMode	Indicates whether Simulink should run in normal, accelerated, rapid accelerator or external mode.	{'normal'}   'accelerator'   'rapid'   'external'
SimulationStatus	Indicates simulation status.	{'stopped'}   'updating'   'initializing'   'running'   'paused'   'terminating'   'external'
SimulationTime	Current time value for the simulation.	double {0}
SingleTaskRateTransMsg	Specifies diagnostic action to take when a rate transition takes place between two blocks operating in single-tasking mode. Set by the <b>Single task rate transition</b> control on the <b>Sample Time Diagnostics</b> pane of the <b>Configuration Parameters</b> dialog box.	{'none'}   'warning'   'error'

**Model Parameters (Continued)**

Parameter	Description	Values
Solver	Solver used for the simulation. Set by the <b>Solver</b> drop-down list on the <b>Solver</b> pane of the <b>Configuration Parameters</b> dialog box.	'VariableStepDiscrete'   {'ode45'}   'ode23'   'ode113'   'ode15s'   'ode23s'   'ode23t'   'ode23tb'   'FixedStepDiscrete'   'ode5'   'ode4'   'ode3'   'ode2'   'ode1'   'ode14x'
SolverMode	Solver mode for this model. Set by the <b>Tasking mode for periodic sample times</b> option on the <b>Solver</b> pane of the <b>Configuration Parameters</b> dialog box. This option is displayed when the solver option type is Fixed-step.	{'Auto'}   'SingleTasking'   'MultiTasking'
SolverName	Solver used for the simulation. See Solver parameter for more information.	

## Model Parameters (Continued)

Parameter	Description	Values
SolverPrmCheckMsg	<p>Enables diagnostics to control when Simulink automatically selects solver parameters. Set by the <b>Automatic solver parameter selection</b> option on the <b>Diagnostics</b> pane of the <b>Configuration Parameters</b> dialog box.</p> <p>This option notifies you if</p> <ul style="list-style-type: none"> <li>• Simulink changes a user-modified parameter to make it consistent with other model settings</li> <li>• Simulink automatically selects solver parameters for the model, such as <b>FixedStepSize</b></li> </ul>	'none'   {'warning'}   'error'
SolverResetMethod	<p>Set by the <b>Solver reset method</b> option on the <b>Solver</b> pane of the <b>Configuration Parameters</b> dialog box.</p> <p>This option is displayed when the solver option type is <b>Variable-step</b> and the solver is either ode15s (Stiff/NDF), ode23t (Mod. Stiff/Trapezoidal), or ode23tb (Stiff/TR-BDF2).</p>	{'Fast'}   'Robust'
SolverType	<p>Solver type used for the simulation. Set by the <b>Type</b> drop-down list on the <b>Solver</b> pane of the <b>Configuration Parameters</b> dialog box.</p>	{'Variable-step'}   'Fixed-step'

**Model Parameters (Continued)**

<b>Parameter</b>	<b>Description</b>	<b>Values</b>
SortedOrder	Show the sorted order of this model's blocks on the block diagram. Set by the <b>Sorted Order</b> command on the model editor's <b>Format-&gt;Block Displays</b> menu.	'on'   {'off'}
StartFcn	Start simulation callback. Created on the <b>Callbacks</b> pane of the Model Properties dialog box. See "Creating Model Callback Functions" in the Using Simulink documentation for further information.	command or variable {''}
StartTime	Simulation start time. Set by the <b>Start time</b> field on the <b>Solver</b> pane of the <b>Configuration Parameters</b> dialog box.	string {'0.0'}
StateSaveName	State output name to be saved to workspace. Set by the <b>States</b> field on the <b>Data Import/Export</b> pane of the <b>Configuration Parameters</b> dialog box.	variable {'xout'}
StatusBar	Show/hide the status bar on the model editor window. Set by the <b>Status Bar</b> command on the model editor's <b>View</b> menu.	{'on'}   'off'

**Model Parameters (Continued)**

<b>Parameter</b>	<b>Description</b>	<b>Values</b>
StopFcn	Stop simulation callback. Created on the <b>Callbacks</b> pane of the Model Properties dialog box. See “Creating Model Callback Functions” in the Using Simulink documentation for further information.	command or variable { '' }
StopTime	Simulation stop time. Set by the <b>Stop time</b> field on the <b>Solver</b> pane of the <b>Configuration Parameters</b> dialog box.	string { '10.0' }
StrictBusMsg	Specifies diagnostic action to take when Simulink detects a signal that some blocks treat as a mux/vector, while other blocks treat the signal as a bus. Set by the <b>Mux blocks used to create bus signals</b> and <b>Bus signal treated as vector</b> controls on the <b>Connectivity Diagnostics</b> pane of the <b>Configuration Parameters</b> dialog box. See “Intermixing Composite Signal Types” in the Using Simulink documentation for more information.	{ 'None'   'Warning'   'ErrorLevel1'   'WarnOnBusTreatedAsVector'   'ErrorOnBusTreatedAsVector' }
Tag	User-specified text that is assigned to the model’s Tag parameter and saved with the model.	string { '' }

**Model Parameters (Continued)**

<b>Parameter</b>	<b>Description</b>	<b>Values</b>
TargetBitPerChar	Specifies the length in bits of the C char data type supported by the emulation hardware device type targeted by this model. Set by the <b>char</b> control in the <b>Emulation Hardware</b> panel of the <b>Hardware Implementation</b> pane of the <b>Configuration Parameters</b> dialog box.	integer {8}
TargetBitPerInt	Specifies the length in bits of the C int data type supported by the emulation hardware device type targeted by this model. Set by the <b>int</b> control in the <b>Emulation Hardware</b> panel of the <b>Hardware Implementation</b> pane of the <b>Configuration Parameters</b> dialog box.	integer {32}
TargetBitPerLong	Specifies the length in bits of the C long data type supported by the emulation hardware device type targeted by this model. Set by the <b>long</b> control in the <b>Emulation Hardware</b> panel of the <b>Hardware Implementation</b> pane of the <b>Configuration Parameters</b> dialog box.	integer {32}



**Model Parameters (Continued)**

<b>Parameter</b>	<b>Description</b>	<b>Values</b>
TargetBitPerShort	Specifies the length in bits of the C short data type supported by the emulation hardware device type targeted by this model. Set by the <b>short</b> control in the <b>Emulation Hardware</b> panel of the <b>Hardware Implementation</b> pane of the <b>Configuration Parameters</b> dialog box.	integer {16}
TargetEndianness	Specifies the significance of the first byte of a data word of the target hardware. Set by the <b>Byte ordering</b> control in the <b>Emulation Hardware</b> panel of the <b>Hardware Implementation</b> pane of the <b>Configuration Parameters</b> dialog box.	{'Unspecified'}   'LittleEndian'   'BigEndian'
TargetFcnLib	For internal use.	
TargetHWDeviceType	Specifies the characteristics of hardware used to emulate the production hardware. Set by the <b>Device type</b> control in the <b>Emulation Hardware</b> panel of the <b>Hardware Implementation</b> pane of the <b>Configuration Parameters</b> dialog box.	string {'32-bit Generic'}

**Model Parameters (Continued)**

<b>Parameter</b>	<b>Description</b>	<b>Values</b>
TargetIntDivRoundTo	Specifies how an ANSI C conforming compiler used to compile code for the emulation hardware targeted by this model rounds the result of dividing one signed integer by another to produce a signed integer quotient. Set by the <b>Signed integer division rounds to</b> control in the <b>Emulation Hardware Implementation</b> pane of the <b>Configuration Parameters</b> dialog box.	'Floor'   'Zero'   {'Undefined'}
TargetShiftRightIntArith	Specifies whether the C compiler implements a signed integer right shift as an arithmetic right shift. Set by the <b>Shift right on a signed integer as arithmetic shift</b> control in the <b>Emulation Hardware Implementation</b> pane of the <b>Configuration Parameters</b> dialog box.	{'on'}   'off'
TargetTypeEmulationWarnSuppressLevel	Specifies whether Real-Time Workshop displays or suppresses warning messages when emulating integer sizes in rapid prototyping environments.	integer {0}

**Model Parameters (Continued)**

<b>Parameter</b>	<b>Description</b>	<b>Values</b>
TargetWordSize	Specifies the word length in bits of the emulation hardware device type targeted by this model. Set by the <b>native word size</b> control in the <b>Emulation Hardware</b> panel of the <b>Hardware Implementation</b> pane of the <b>Configuration Parameters</b> dialog box.	integer {32}
TasksWithSamePriorityMsg	Specifies diagnostic action to take when tasks have equal priority. Set by the <b>Tasks with equal priority</b> control on the <b>Sample Time Diagnostics</b> pane of the <b>Configuration Parameters</b> dialog box.	'none'   {'warning'}   'error'
TiledPageScale	Scales the size of the tiled page relative to the model.	string {'1'}
TiledPaperMargins	Controls the size of the margins associated with each tiled page. Each element in the vector represents a margin at the particular edge.	[left, top, right, bottom]
TimeAdjustmentMsg	Specifies diagnostic action to take if Simulink makes a minor adjustment to a sample hit time while running the model. Set by the <b>Sample hit time adjusting</b> option on the <b>Diagnostics</b> pane of the <b>Configuration Parameters</b> dialog box.	{'none'}   'warning'   'error'

**Model Parameters (Continued)**

<b>Parameter</b>	<b>Description</b>	<b>Values</b>
TimeSaveName	Simulation time name. Set by the <b>Time</b> field on the <b>Data Import/Export</b> pane of the <b>Configuration Parameters</b> dialog box.	variable {'tout'}
TLC...	Parameters whose names begin with TLC are used for code generation. See the Real-Time Workshop documentation for more information.	
Toolbar	Show/hide the toolbar on the Model Editor window. Set by the <b>Toolbar</b> command on the model editor's <b>View</b> menu.	{'on'}   'off'
TryForcingSFcnDF	This flag is used for backward compatibility with user S-functions that were written prior to R12.	'on'   {'off'}
TunableVars	List of global (tunable) parameters. Set in the <b>Model Parameter Configuration</b> dialog box.	string {''}
TunableVarsStorageClass	List of storage classes for their respective tunable parameters. Set in the <b>Model Parameter Configuration</b> dialog box.	string {''}
TunableVarsTypeQualifier	List of storage type qualifiers for their respective tunable parameters. Set in the <b>Model Parameter Configuration</b> dialog box.	string {''}

**Model Parameters (Continued)**

<b>Parameter</b>	<b>Description</b>	<b>Values</b>
Type	Simulink object type (read only).	'block_diagram'
UnconnectedInputMsg	Unconnected input ports diagnostic. Set by the <b>Unconnected block input ports</b> option on the <b>Connectivity Diagnostics</b> pane of the <b>Configuration Parameters</b> dialog box.	'none'   {'warning'}   'error'
UnconnectedLineMsg	Unconnected lines diagnostic. Set by the <b>Unconnected line</b> option on the <b>Connectivity Diagnostics</b> pane of the <b>Configuration Parameters</b> dialog box.	'none'   {'warning'}   'error'
UnconnectedOutputMsg	Unconnected block output ports diagnostic. Set by the <b>Unconnected block output ports</b> option on the <b>Connectivity Diagnostics</b> pane of the <b>Configuration Parameters</b> dialog box.	'none'   {'warning'}   'error'
UnderSpecifiedDataTypeMsg	Detect usage of heuristics to assign signal data types. Set by the <b>Underspecified data types</b> option on the <b>Diagnostics Data Validity</b> pane of the <b>Configuration Parameters</b> dialog box.	{'none'}   'warning'   'error'

**Model Parameters (Continued)**

<b>Parameter</b>	<b>Description</b>	<b>Values</b>
UniqueDataStoreMsg	Specifies diagnostic action to take when the model contains multiple Data Store Memory blocks that specify the same data store name. Set by the <b>Duplicate data store names</b> control on the <b>Diagnostics Data Validity</b> pane of the <b>Configuration Parameters</b> dialog box.	{ 'none' }   'warning'   'error'
UnknownTsInhSupMsg	Detect blocks that have not set whether they allow the model containing them to inherit a sample time. Set by the <b>Unspecified inheritability of sample time</b> option on the <b>Diagnostics</b> pane of the <b>Configuration Parameters</b> dialog box.	'none'   { 'warning' }   'error'
UnnecessaryDatatype-ConvMsg	Detect unnecessary data type conversion blocks. Set by the <b>Unnecessary type conversions</b> option on the <b>Type Conversion Diagnostics</b> pane of the <b>Configuration Parameters</b> dialog box.	{ 'none' }   'warning'

**Model Parameters (Continued)**

<b>Parameter</b>	<b>Description</b>	<b>Values</b>
UpdateHistory	Specifies when to prompt the user about updating the model history. This is set by the <b>Prompt to update model history</b> parameter on the History pane of the Model Properties dialog box. See “Model History Controls” in the Using Simulink documentation for further information.  This is also set by the <b>Prompt to update model history</b> option on lower right of the <b>History</b> pane of the <b>Model Explorer</b> dialog box.	{ 'UpdateHistoryNever' }   'UpdateHistoryWhenSave'
UpdateModelReference-Targets	Rebuilding options. Set on the <b>Model Referencing</b> pane of the <b>Configuration Parameters</b> dialog box.	'IfOutOfDate'   'Force'   'AssumeUpToDate'   { 'IfOutOfDateOrStructural Change' }
UseAnalysisPorts	For internal use.	
VectorMatrixConversionMsg	Detect vector-to-matrix or matrix-to-vector conversions. Set by the <b>Vector/matrix block input conversion</b> option on the <b>Type Conversion Diagnostics</b> pane of the <b>Configuration Parameters</b> dialog box.	{ 'none' }   'warning'   'error'
Version	Simulink version used to modify the model (read only).	release version number

**Model Parameters (Continued)**

<b>Parameter</b>	<b>Description</b>	<b>Values</b>
WideLines	Draws lines that carry vector or matrix signals wider than lines that carry scalar signals. Set by the <b>Wide Nonscalar Lines</b> command on the model editor's <b>Format-&gt;Port/Signal Displays</b> menu.	'on'   {'off'}
WideVectorLines	Deprecated. Use WideLines instead.	
WriteAfterReadMsg	Specifies diagnostic action to take when the model attempts to store data in a data store after previously reading data from it in the current time step. Set by the <b>Detect write after read</b> control on the <b>Diagnostics Data Validity</b> pane of the <b>Configuration Parameters</b> dialog box.	{ 'UseLocalSettings'   'DisableAll'   'EnableAllAsWarning'   'EnableAllAsError' }
WriteAfterWriteMsg	Specifies diagnostic action to take when the model attempts to store data in a data store twice in succession in the current time step. Set by the <b>Detect write after write</b> control on the <b>Diagnostics Data Validity</b> pane of the <b>Configuration Parameters</b> dialog box.	{ 'UseLocalSettings'   'DisableAll'   'EnableAllAsWarning'   'EnableAllAsError' }
ZeroCross	For internal use.	



## Model Parameters (Continued)

Parameter	Description	Values
ZeroCrossControl	Enable zero-crossing detection. Set by the <b>Zero crossing control</b> control on the <b>Solver</b> pane of the <b>Configuration Parameters</b> dialog box.	{ 'UseLocalSettings'   'EnableAll'   'DisableAll' }
ZoomFactor	Zoom factor of the model editor window expressed as a percentage of normal (100%) or by the keywords <code>FitSystem</code> or <code>FitSelection</code> . Set by the zoom commands on the model editor's <b>View</b> menu.	string { '100'   'FitSystem'   'FitSelection' }

## Examples of Setting Model Parameters

These examples show how to set model parameters for the `mymodel` system.

This command sets the simulation start and stop times.

```
set_param('mymodel', 'StartTime', '5', 'StopTime', '100')
```

This command sets the solver to `ode15s` and changes the maximum order.

```
set_param('mymodel', 'Solver', 'ode15s', 'MaxOrder', '3')
```

This command associates a `SaveFcn` callback.

```
set_param('mymodel', 'SaveFcn', 'my_save_cb')
```

## Common Block Parameters

### In this section...

“About Common Block Parameters” on page 8-66

“Examples of Setting Block Parameters” on page 8-78

### About Common Block Parameters

This table lists the parameters common to all Simulink blocks, including block callback parameters (see “Using Callback Functions”). Examples of commands that change these parameters follow this table (see “Examples of Setting Block Parameters” on page 8-78).

#### Common Block Parameters

Parameter	Description	Values
AncestorBlock	Name of the library block that the block is linked to (for blocks with a disabled link).	string
AttributesFormatString	String format specified for block annotations in the <b>Block Parameters</b> dialog box.	string
BackgroundColor	Block background color.	RGB value array string   [r,g,b,a] where r, g, b, and a are the red, green, blue, and alpha values of the color normalized to the range 0.0 to 1.0. The alpha value is ignored.
BlockDescription	Block description shown in the <b>Block Properties</b> dialog box.	string

**Common Block Parameters (Continued)**

<b>Parameter</b>	<b>Description</b>	<b>Values</b>
BlockType	Block type (read only).	string
ClipboardFcn	Function called when block is copied to the clipboard ( <b>Ctrl+C</b> )	string
CloseFcn	Function called when <code>close_system</code> is run on block.	string
CompiledPort-ComplexSignals	Complexity of port signals after updating diagram.	structure array
CompiledPortDataTypes	Data types of port signals after updating diagram.	structure array
CompiledPortDimensions	Dimensions of port signals after updating diagram.	structure array
CompiledPortFrameData	Frame mode of port signals after updating diagram.	structure array
CompiledPortWidths	Structure of port widths after updating diagram.	structure array
CompiledSampleTime	Block sample time after updating diagram.	vector [sample time, offset time]
CopyFcn	Function called when block is copied.	string
DataTypeOverrideCompiled	For internal use.	

**Common Block Parameters (Continued)**

<b>Parameter</b>	<b>Description</b>	<b>Values</b>
DeleteFcn	Function called when block is deleted. If a block is graphically deleted, you can still undo the operation and call the block's UndoDeleteFcn. In addition, for graphically deleted blocks, the block's DestroyFcn is still called when the model is closed or any subsystem containing the block is destroyed using delete_block.	MATLAB expression
DestroyFcn	Function called when block is destroyed. If you run the delete_block command for a block, it first calls the block's DeleteFcn, then calls the DestroyFcn for that block; no undo is possible. The DestroyFcn is also called when you close the model or invoke delete_block on a subsystem containing the block.	MATLAB expression
Description	Description of block. Set by the <b>Description</b> field in the <b>General</b> pane of the <b>Block Properties</b> dialog box.	text and tokens
Diagnostics	For internal use.	
DialogParameters	Names/attributes of parameters in block's parameter dialog box.	structure
DropShadow	Display drop shadow.	{'off'}   'on'

**Common Block Parameters (Continued)**

<b>Parameter</b>	<b>Description</b>	<b>Values</b>
ExtModeLoggingSupported	Enable a block to support uploading of signal data in external mode (for example, with a scope block).	{ 'off' }   'on'
ExtModeLoggingTrig	Enable a block to act as the trigger block for external mode signal uploading.	{ 'off' }   'on'
FontAngle	Font angle.	'normal'   'italic'   'oblique'   {'auto'}
FontName	Font.	string
FontSize	Font size. A value of -1 specifies that this block inherits the font size specified by the DefaultBlockFontSize model parameter.	real {'-1'}
FontWeight	Font weight.	'light'   'normal'   'demi'   'bold'   {'auto'}
ForegroundColor	Foreground color of block's icon.	string {'black'}   [r,g,b,a] where r, g, b, and a are the red, green, blue, and alpha values of the color normalized to the range 0.0 to 1.0. The alpha value is ignored.
Handle	Block handle.	real
HiliteAncestors	For internal use.	

**Common Block Parameters (Continued)**

<b>Parameter</b>	<b>Description</b>	<b>Values</b>
InitFcn	Initialization function for a masked block. Created on the <b>Callbacks</b> pane of the Model Properties dialog box. See “Creating Model Callback Functions” in the Using Simulink documentation for further information.	MATLAB expression
InputSignalNames	Names of input signals.	cell array
IOSignalStrings		list
IOType	Signal & Scope Manager type.	{'none'}   'viewer'   'sigen'
LineHandles	Handles of lines connected to block.	struct
LinkStatus	Link status of block. Updates out-of-date reference blocks when queried using <code>get_param</code> .	{'none'}   'resolved'   'unresolved'   'implicit'   'inactive'   'restore'   'propagate'
LoadFcn	Function called when block is loaded.	MATLAB expression
MinMaxOverflow-Logging_Compiled	For internal use.	
ModelCloseFcn	Function called when model is closed. The <code>ModelCloseFcn</code> is called prior to the block's <code>DeleteFcn</code> and <code>DestroyFcn</code> callbacks, if either are set.	MATLAB expression
ModelParamTableInfo	For internal use.	
MoveFcn	Function called when block is moved.	MATLAB expression
Name	Block name.	string

**Common Block Parameters (Continued)**

<b>Parameter</b>	<b>Description</b>	<b>Values</b>
NameChangeFcn	Function called when block name is changed.	MATLAB expression
NamePlacement	Position of block name.	{'normal'}   'alternate'
ObjectParameters	Names/attributes of block's parameters.	structure
OpenFcn	Function called when this block's <b>Block Parameters</b> dialog box is opened.	MATLAB expression
Orientation	Where block faces.	{'right'}   'left'   'up'   'down'
OutputSignalNames	Names of output signals.	cell array
Parent	Name of the system that owns the block.	string {'untitled'}
ParentCloseFcn	Function called when parent subsystem is closed. The ParentCloseFcn of blocks at the root model level is not called when the model is closed.	MATLAB expression

## Common Block Parameters (Continued)

Parameter	Description	Values
PortConnectivity	<p>The value of this parameter is an array of structures, each of which describes one of the block's input or output ports. Each port structure has the following fields:</p> <ul style="list-style-type: none"> <li>• Type <p>Specifies the port's type and/or number. The value of this field can be:</p> <ul style="list-style-type: none"> <li>▪ <math>n</math>, where <math>n</math> is the number of the port for data ports</li> <li>▪ 'enable' if the port is an enable port</li> <li>▪ 'trigger' if the port is a trigger port</li> <li>▪ 'state' for state ports</li> <li>▪ 'ifaction' for action ports</li> <li>▪ 'LConn#' for a left connection port where # is the port's number</li> <li>▪ 'RConn#' for a right connection port where # is the port's number</li> </ul> </li> <li>• Position <p>The value of this field is a two-element vector, <math>[x\ y]</math>, that specifies the port's position.</p> </li> </ul>	structure array



**Common Block Parameters (Continued)**

Parameter	Description	Values
	<ul style="list-style-type: none"> <li data-bbox="546 371 694 395">• SrcBlock Handle of the block connected to this port. This field is null for output ports.</li> <li data-bbox="546 562 679 586">• SrcPort Number of the port connected to this port. This field is null for output ports.</li> <li data-bbox="546 753 694 777">• DstBlock Handle of the block to which this port is connected. This field is null for input ports.</li> <li data-bbox="546 909 679 933">• DstPort Number of the port to which this port is connected. This field is null for input ports.</li> </ul>	

**Common Block Parameters (Continued)**

Parameter	Description	Values
PortHandles	<p>The value of this parameter is a structure that specifies the handles of the block's ports. The structure has the following fields:</p> <ul style="list-style-type: none"> <li>• Inport Handles of the block's input ports.</li> <li>• Outport Handles of the block's output ports.</li> <li>• Enable Handle of the block's enable port.</li> <li>• Trigger Handle of the block's trigger port.</li> <li>• State Handle of the block's state port.</li> <li>• LConn Handles of the block's left connection ports.</li> <li>• RConn Handles of the block's right connection ports.</li> <li>• Ifaction Handle of the block's action port.</li> </ul>	structure array

**Common Block Parameters (Continued)**

<b>Parameter</b>	<b>Description</b>	<b>Values</b>
Ports	<p>The value of this parameter is a vector that specifies the numbers of each kind of port. The order of the vector's elements corresponds to the following port types:</p> <ul style="list-style-type: none"> <li>• Inport</li> <li>• Outport</li> <li>• Enable</li> <li>• Trigger</li> <li>• State</li> <li>• LConn</li> <li>• RConn</li> <li>• Ifaction</li> </ul>	vector
Position	Position of block in model window.	vector [left top right bottom] not enclosed in quotation marks. The maximum value for a coordinate is 32767.
PostSaveFcn	Function called after the block is saved. Created on the <b>Callbacks</b> pane of the Model Properties dialog box. See "Creating Model Callback Functions" in the Using Simulink documentation for further information.	MATLAB expression

**Common Block Parameters (Continued)**

Parameter	Description	Values
PreCopyFcn	Function called before the block is copied. See “Block Callback Parameters” in the Using Simulink documentation for details.	MATLAB expression
PreDeleteFcn	Function called before the block is deleted. See “Block Callback Parameters” in the Using Simulink documentation for details.	MATLAB expression
PreSaveFcn	Function called before the block is saved.	MATLAB expression
Priority	Specifies the block’s order of execution relative to other blocks in the same model. Set by the <b>Priority</b> field on the <b>General</b> pane of the <b>Block Properties</b> dialog box.	string { ' ' }
ReferenceBlock	Name of the library block that this block is linked to.	string { ' ' }
RequirementInfo	For internal use.	
RTWData	User specified data, used by Real-Time Workshop.	
SampleTime	Value of the sample time parameter.	string
Selected	Status of whether or not block is selected.	{ 'on' }   'off'
ShowName	Display block name.	{ 'on' }   'off'

**Common Block Parameters (Continued)**

<b>Parameter</b>	<b>Description</b>	<b>Values</b>
StartFcn	Function called at the start of a simulation.	MATLAB expression
StatePerturbation-ForJacobian	State perturbation size to use during linearization. See the “Linearizing Individual Blocks Using Block Perturbation” in the Simulink Control Design documentation for details.	string
StaticLinkStatus	Link status of block. Does not update out-of-date reference blocks when queried using get_param.	{'none'}   'resolved'   'unresolved'   'implicit'   'inactive'   'restore'   'propagate'
StopFcn	Function called at the termination of a simulation.	MATLAB expression
Tag	Text that appears in the block label that Simulink generates. Set by the <b>Tag</b> field on the <b>General</b> pane of the <b>Block Properties</b> dialog box.	string {' '}
Type	Simulink object type (read only).	'block'
UndoDeleteFcn	Function called when block deletion is undone.	MATLAB expression
UserData	User-specified data that can have any MATLAB data type.	{'[]'}
UserDataPersistent	Status of whether or not UserData will be saved in the model file.	'on'   {'off'}

## Examples of Setting Block Parameters

These examples illustrate how to change common block parameters.

This command changes the orientation of the Gain block in the `mymodel` system so it faces the opposite direction (right to left).

```
set_param('mymodel/Gain','Orientation','left')
```

This command associates an `OpenFcn` callback with the Gain block in the `mymodel` system.

```
set_param('mymodel/Gain','OpenFcn','my_open_cb')
```

This command sets the `Position` parameter of the Gain block in the `mymodel` system. The block is 75 pixels wide by 25 pixels high. The position vector is *not* enclosed in quotation marks.

```
set_param('mymodel/Gain','Position',[50 250 125 275])
```

## Block-Specific Parameters

These tables list block-specific parameters for all Simulink blocks. The type of the block appears in parentheses after the block name. Some Simulink blocks are implemented as masked subsystems. The tables indicate masked blocks by adding the designation "masked" after the block type.

---

**Note** The type listed for nonmasked blocks is the value of the block's BlockType parameter (see "Common Block Parameters" on page 8-66); the type listed for masked blocks is the value of the block's MaskType parameter (see "Mask Parameters" on page 8-183).

---

The **Dialog Box Prompt** column indicates the text of the prompt for the parameter on the block's dialog box. The **Values** column shows the type of value required (scalar, vector, variable), the possible values (separated with a vertical line), and the default value (enclosed in braces).

- Continuous Library Block Parameters
- Discontinuities Library Block Parameters
- Discrete Library Block Parameters
- Logic and Bit Operations Library Block Parameters
- Lookup Tables Block Parameters
- Math Operations Library Block Parameters
- Model Verification Library Block Parameters
- Model-Wide Utilities Library Block Parameters
- Ports & Subsystems Library Block Parameters
- Signal Attributes Library Block Parameters
- Signal Routing Library Block Parameters
- Sinks Library Block Parameters
- Sources Library Block Parameters
- User-Defined Functions Library Block Parameters

- Additional Discrete Block Library Parameters
- Additional Math: Increment - Decrement Block Parameters

**Continuous Library Block Parameters**

Block (Type)/Parameter	Dialog Box Prompt	Values
Derivative (Derivative)		
LinearizePole	Linearization Time Constant $s/(Ns+1)$	string {'inf'}
Integrator (Integrator)		
ExternalReset	External reset	{'none'}   'rising'   'falling'   'either'   'level'
InitialConditionSource	Initial condition source	{'internal'}   'external'
InitialCondition	Initial condition	scalar or vector {0}
LimitOutput	Limit output	{'off'}   'on'
UpperSaturationLimit	Upper saturation limit	scalar or vector {'inf'}
LowerSaturationLimit	Lower saturation limit	scalar or vector {'-inf'}
ShowSaturationPort	Show saturation port	{'off'}   'on'
ShowStatePort	Show state port	{'off'}   'on'
AbsoluteTolerance	Absolute tolerance	string {'auto'}
ZeroCross	Enable zero-crossing detection	'off'   {'on'}
ContinuousStateAttributes	State Name	string{''}   variable
State-Space (StateSpace)		
A	A	matrix {'1'}
B	B	matrix {'1'}
C	C	matrix {'1'}
D	D	matrix {'1'}
X0	Initial conditions	vector {'0'}



**Continuous Library Block Parameters (Continued)**

<b>Block (Type)/Parameter</b>	<b>Dialog Box Prompt</b>	<b>Values</b>
AbsoluteTolerance	Absolute tolerance	string {'auto'}
ContinuousStateAttributes	State Name	string{'' }   variable
<b>Transfer Fcn (TransferFcn)</b>		
Numerator	Numerator	vector or matrix {'[1]'} {'1 1'}
Denominator	Denominator	vector {'[1 1]'} {'1 1'}
AbsoluteTolerance	Absolute tolerance	string {'auto'}
ContinuousStateAttributes	State Name	string{'' }   variable
<b>Transport Delay (TransportDelay)</b>		
DelayTime	Time delay	scalar or vector {'1'}
InitialOutput	Initial output	scalar or vector {'0'}
BufferSize	Initial buffer size	scalar {'1024'}
FixedBuffer	Use fixed buffer size	{'off'}   'on'
PadeOrder	Pade order (for linearization)	string {'0'}
TransDelayFeedthrough	Direct feedthrough of input during linearization	{'off'}   'on'
<b>Variable Time Delay (VariableTimeDelay)</b>		
VariableDelayType	Select delay type	'Variable transport delay'   {'Variable time delay'}
MaximumDelay	Maximum delay	scalar or vector {'10'}
InitialOutput	Initial output	scalar or vector {'0'}
MaximumPoints	Initial buffer size	scalar {'1024'}
FixedBuffer	Use fixed buffer size	{'off'}   'on'
ZeroDelay	Handle zero delay	{'off'}   'on'
TransDelayFeedthrough	Direct feedthrough of input during linearization	{'off'}   'on'

**Continuous Library Block Parameters (Continued)**

<b>Block (Type)/Parameter</b>	<b>Dialog Box Prompt</b>	<b>Values</b>
PadeOrder	Pade order (for linearization)	string {'0'}
ContinuousStateAttributes	State Name	string{''  variable
<b>Variable Transport Delay (VariableTransportDelay)</b>		
VariableDelayType	Select delay type	{'Variable transport delay'  'Variable time delay'
MaximumDelay	Maximum delay	scalar or vector {'10'}
InitialOutput	Initial output	scalar or vector {'0'}
MaximumPoints	Initial buffer size	scalar {'1024'}
FixedBuffer	Use fixed buffer size	{'off'  'on'
PadeOrder	Pade order (for linearization)	string {'0'}
TransDelayFeedthrough	Direct feedthrough of input during linearization	{'off'  'on'
AbsoluteTolerance	Absolute tolerance	scalar {'auto'}
ContinuousStateAttributes	State Name	string{''  variable
<b>Zero-Pole (ZeroPole)</b>		
Zeros	Zeros	vector {'[1]'
Poles	Poles	vector {'[0 -1]'
Gain	Gain	vector {'[1]'

**Continuous Library Block Parameters (Continued)**

Block (Type)/Parameter	Dialog Box Prompt	Values
AbsoluteTolerance	Absolute tolerance	string {'auto'}
ContinuousStateAttributes	State Name	string{''}   variable

**Discontinuities Library Block Parameters**

Block (Type)/Parameter	Dialog Box Prompt	Values
Backlash (Backlash)		
BacklashWidth	Deadband width	scalar or vector {1}
InitialOutput	Initial output	scalar or vector {0}
ZeroCross	Enable zero crossing detection	'off'   {'on'}
SampleTime	Sample time (-1 for inherited)	string {'-1'}
Coulomb & Viscous Friction (Coulombic and Viscous Friction) (masked subsystem)		
offset	Coulomb friction value (Offset)	string {'[1 3 2 0]'}
gain	Coefficient of viscous friction (Gain)	string {'1'}
Dead Zone (DeadZone)		
LowerValue	Start of dead zone	scalar or vector {-0.5}
UpperValue	End of dead zone	scalar or vector {0.5}
SaturateOnIntegerOverflow	Saturate on integer overflow	'off'   {'on'}
LinearizeAsGain	Treat as gain when linearizing	'off'   {'on'}
ZeroCross	Enable zero crossing detection	'off'   {'on'}
SampleTime	Sample time (-1 for inherited)	string {'-1'}
Dead Zone Dynamic (Dead Zone Dynamic) (masked subsystem)		
Hit Crossing (HitCross)		
HitCrossingOffset	Hit crossing offset	scalar or vector {'0'}

**Discontinuities Library Block Parameters (Continued)**

<b>Block (Type)/Parameter</b>	<b>Dialog Box Prompt</b>	<b>Values</b>
HitCrossingDirection	Hit crossing direction	'rising'   'falling'   {'either'}
ShowOutputPort	Show output port	{'on'}   'off'
ZeroCross	Enable zero crossing detection	'off'   {'on'}
SampleTime	Sample time (-1 for inherited)	string {'-1'}
<b>Quantizer (Quantizer)</b>		
QuantizationInterval	Quantization interval	scalar or vector {'0.5'}
LinearizeAsGain	Treat as gain when linearizing	'off'   {'on'}
SampleTime	Sample time (-1 for inherited)	string {'-1'}
<b>Rate Limiter (RateLimiter)</b>		
RisingSlewLimit	Rising slew rate	string {'1'}
FallingSlewLimit	Falling slew rate	string {'-1'}
SampleTimeMode	Sample time mode	'continuous'   {'inherited'}
InitialCondition	Initial condition	string {'0'}
LinearizeAsGain	Treat as gain when linearizing	'off'   {'on'}
<b>Rate Limiter Dynamic (Rate Limiter Dynamic) (masked subsystem)</b>		
<b>Relay (Relay)</b>		
OnSwitchValue	Switch on point	string {'eps'}
OffSwitchValue	Switch off point	string {'eps'}
OnOutputValue	Output when on	string {'1'}
OffOutputValue	Output when off	string {'0'}
OutMin	Output minimum	string {'[]'}
OutMax	Output maximum	string {'[]'}

**Discontinuities Library Block Parameters (Continued)**

<b>Block (Type)/Parameter</b>	<b>Dialog Box Prompt</b>	<b>Values</b>
OutDataTypeStr	Output data type	string 'Inherit: Inherit via back propagation'   {'Inherit: All ports same datatype'}   'double'   'single'   'int8'   'uint8'   'int16'   'uint16'   'int32'   'uint32'
ZeroCross	Enable zero crossing detection	'off'   {'on'}
SampleTime	Sample time (-1 for inherited)	string {'-1'}
<b>Saturation (Saturate)</b>		
UpperLimit	Upper limit	scalar or vector {'0.5'}
LowerLimit	Lower limit	scalar or vector {'-0.5'}
LinearizeAsGain	Treat as gain when linearizing	'off'   {'on'}
ZeroCross	Enable zero crossing detection	'off'   {'on'}
SampleTime	Sample time (-1 for inherited)	string {'-1'}
OutMin	Output minimum	string {'[]'}
OutMax	Output maximum	string {'[]'}
OutDataTypeStr	Output data type	string 'Inherit: Inherit via back propagation'   {'Inherit: Same as input'}   'double'   'single'   'int8'   'uint8'   'int16'   'uint16'   'int32'   'uint32'
LockScale	Lock output scaling against changes by the autoscaling tool	{'off'}   'on'

**Discontinuities Library Block Parameters (Continued)**

<b>Block (Type)/Parameter</b>	<b>Dialog Box Prompt</b>	<b>Values</b>
RndMeth	Round integer calculations toward	'Zero'   'Nearest'   'Ceiling'   {'Floor'}
Saturation Dynamic (Saturation Dynamic) (masked subsystem)		
OutMin	Output minimum	string {'[]'}
OutMax	Output maximum	string {'[]'}
OutDataTypeStr	Output data type	string {'Inherit: Same as second input'}   'double'   'single'   'int8'   'uint8'   'int16'   'uint16'   'int32'   'uint32'
OutputDataTypeScaling Mode	Deprecated	
OutDataType	Deprecated	
OutScaling	Deprecated	
LockScale	Lock output scaling against changes by the autoscaling tool	{'off'}   'on'
RndMeth	Round integer calculations toward	'Zero'   'Nearest'   'Ceiling'   {'Floor'}
DoSatur	Saturate on integer overflow	{'off'}   'on'
Wrap To Zero (Wrap To Zero) (masked subsystem)		
Threshold	Threshold	string {'255'}

**Discrete Library Block Parameters**

<b>Block (Type)/Parameter</b>	<b>Dialog Box Prompt</b>	<b>Values</b>
Difference (Difference) (masked subsystem)		

**Discrete Library Block Parameters (Continued)**

<b>Block (Type)/Parameter</b>	<b>Dialog Box Prompt</b>	<b>Values</b>
ICPrevInput	Initial condition for previous input	string {'0.0'}
OutMin	Output minimum	string {'[]'}
OutMax	Output maximum	string {'[]'}
OutDataTypeStr	Output data type	string {'Inherit: Inherit via internal rule'}   'Inherit: Inherit via back propagation'   'double'   'single'   'int8'   'uint8'   'int16'   'uint16'   'int32'   'uint32'
OutputDataTypeScaling Mode	Deprecated	
OutDataType	Deprecated	
OutScaling	Deprecated	
LockScale	Lock output scaling against changes by the autoscaling tool	{'off'}   'on'
RndMeth	Round toward	'Zero'   'Nearest'   'Ceiling'   {'Floor'}
DoSatur	Saturate to max or min when overflows occur	{'off'}   'on'
Discrete Derivative (Discrete Derivative) (masked subsystem)		
gainval	Gain value	string {'1.0'}
ICPrevScaledInput	Initial condition for previous weighted input $K*u/Ts$	string {'0.0'}
OutMin	Output minimum	string {'[]'}
OutMax	Output maximum	string {'[]'}

**Discrete Library Block Parameters (Continued)**

<b>Block (Type)/Parameter</b>	<b>Dialog Box Prompt</b>	<b>Values</b>
OutDataTypeStr	Output data type	string {'Inherit: Inherit via internal rule'}   'Inherit: Inherit via back propagation'   'double'   'single'   'int8'   'uint8'   'int16'   'uint16'   'int32'   'uint32'
OutputDataTypeScaling Mode	Deprecated	
OutDataType	Deprecated	
OutScaling	Deprecated	
LockScale	Lock output scaling against changes by the autoscaling tool	{'off'}   'on'
RndMeth	Round toward	'Zero'   'Nearest'   'Ceiling'   {'Floor'}
DoSatur	Saturate to max or min when overflows occur	{'off'}   'on'
<b>Discrete Filter (DiscreteFilter)</b>		
Numerator	Numerator	vector {'[1]'} vector {'[1 0.5]'}
Denominator	Denominator	
SampleTime	Sample time (-1 for inherited)	string {'1'}
StateIdentifier	State name	string {}
StateMustResolveTo SignalObject	State name must resolve to Simulink signal object	{'off'}   'on'
RTWStateStorageClass	RTW storage class	{'Auto'}   'ExportedGlobal'   'ImportedExtern'   'ImportedExternPointer'





**Discrete Library Block Parameters (Continued)**

<b>Block (Type)/Parameter</b>	<b>Dialog Box Prompt</b>	<b>Values</b>
RTWStateStorageClass	RTW storage class	{ 'Auto' }   'ExportedGlobal'   'ImportedExtern'   'ImportedExternPointer'
RTWStateStorageType Qualifier	RTW storage type qualifier	string { }
<b>Discrete Zero-Pole (DiscreteZeroPole)</b>		
Zeros	Zeros	vector { '[1]' }
Poles	Poles	vector { '[0 0.5]' }
Gain	Gain	string { '1' }
SampleTime	Sample time (-1 for inherited)	string { '1' }
StateIdentifier	State name	string { }
StateMustResolveTo SignalObject	State name must resolve to Simulink signal object	{ 'off' }   'on'
RTWStateStorageClass	RTW storage class	{ 'Auto' }   'ExportedGlobal'   'ImportedExtern'   'ImportedExternPointer'
RTWStateStorageType Qualifier	RTW storage type qualifier	string { }
<b>Discrete-Time Integrator (DiscreteIntegrator)</b>		

**Discrete Library Block Parameters (Continued)**

<b>Block (Type)/Parameter</b>	<b>Dialog Box Prompt</b>	<b>Values</b>
IntegratorMethod	Integrator method	{'Integration: Forward Euler'}   {'Integration: Backward Euler'}   {'Integration: Trapezoidal'}   {'Accumulation: Forward Euler'}   {'Accumulation: Backward Euler'}   {'Accumulation: Trapezoidal'}
gainval	Gain value	string {'1.0'}
ExternalReset	External reset	{'none'}   {'rising'}   {'falling'}   {'either'}   {'level'}
InitialConditionSource	Initial condition source	{'internal'}   {'external'}
InitialCondition	Initial condition	scalar or vector {'0'}
InitialConditionMode	Use initial condition as initial and reset value for	'State only (most efficient)'   {'State and output'}
SampleTime	Sample time (-1 for inherited)	string {'1'}
OutMin	Output minimum	string {'[]'}
OutMax	Output maximum	string {'[]'}
OutDataTypeStr	Output data type	string {'Inherit: Inherit via internal rule'}   {'Inherit: Inherit via back propagation'}   {'double'}   {'single'}   {'int8'}   {'uint8'}   {'int16'}   {'uint16'}   {'int32'}   {'uint32'}

**Discrete Library Block Parameters (Continued)**

<b>Block (Type)/Parameter</b>	<b>Dialog Box Prompt</b>	<b>Values</b>
LockScale	Lock output scaling against changes by the autoscaling tool	{'off'}   'on'
RndMeth	Round integer calculations toward	'Zero'   'Nearest'   'Ceiling'   {'Floor'}
SaturateOnInteger Overflow	Saturate on integer overflow	{'off'}   'on'
LimitOutput	Limit output	{'off'}   'on'
UpperSaturationLimit	Upper saturation limit	scalar or vector {'inf'}
LowerSaturationLimit	Lower saturation limit	scalar or vector {'-inf'}
ShowSaturationPort	Show saturation port	{'off'}   'on'
ShowStatePort	Show state port	{'off'}   'on'
IgnoreLimit	Ignore limit and reset when linearizing	{'off'}   'on'
StateIdentifier	State name	string {' '}
StateMustResolveTo SignalObject	State name must resolve to Simulink signal object	{'off'}   'on'
RTWStateStorageClass	Real-Time Workshop storage class	{'Auto'}   'ExportedGlobal'   'ImportedExtern'   'ImportedExternPointer'
RTWStateStorageType Qualifier	Real-Time Workshop storage type qualifier	string {' '}
<b>First-Order Hold (First-Order Hold) (masked subsystem)</b>		
Ts	Sample time	string {'1'}
<b>Integer Delay (S-Function) (Integer Delay) (masked subsystem)</b>		
vinit	Initial condition	string {'0.0'}

**Discrete Library Block Parameters (Continued)**

<b>Block (Type)/Parameter</b>	<b>Dialog Box Prompt</b>	<b>Values</b>
samptime	Sample time	string {'-1'}
NumDelays	Number of delays	string {'4'}
<b>Memory (Memory)</b>		
X0	Initial condition	scalar or vector {'0'}
InheritSampleTime	Inherit sample time	{'off'}   'on'
LinearizeMemory	Direct feedthrough of input during linearization	{'off'}   'on'
StateIdentifier	State name	string {}
StateMustResolveToSignalObject	State name must resolve to Simulink signal object	{'off'}   'on'
RTWStateStorageClass	RTW storage class	{'Auto'}   'ExportedGlobal'   'ImportedExtern'   'ImportedExternPointer'
RTWStateStorageTypeQualifier	RTW storage type qualifier	string {}
<b>Tapped Delay (S-Function) (Tapped Delay Line) (masked subsystem)</b>		
vinit	Initial condition	string {'0.0'}
samptime	Sample time	string {'-1'}
NumDelays	Number of delays	string {'4'}
DelayOrder	Order output vector starting with	{'Oldest'}   'Newest'
includeCurrent	Include current input in output vector	{'off'}   'on'
<b>Transfer Fcn (First Order Transfer Fcn) (masked subsystem)</b>		
PoleZ	Pole (in Z plane)	string {'0.95'}
ICPrevOutput	Initial condition for previous output	string {'0.0'}

**Discrete Library Block Parameters (Continued)**

<b>Block (Type)/Parameter</b>	<b>Dialog Box Prompt</b>	<b>Values</b>
RndMeth	Round toward	'Zero'   'Nearest'   'Ceiling'   {'Floor'}
DoSatur	Saturate to max or min when overflows occur	{'off'}   'on'
Transfer Fcn Lead or Lag (Lead or Lag Compensator) (masked subsystem)		
PoleZ	Pole of compensator (in Z plane)	string {'0.95'}
ZeroZ	Zero of compensator (in Z plane)	string {'0.75'}
ICPrevOutput	Initial condition for previous output	string {'0.0'}
ICPrevInput	Initial condition for previous input	string {'0.0'}
RndMeth	Round toward	'Zero'   'Nearest'   'Ceiling'   {'Floor'}
DoSatur	Saturate to max or min when overflows occur	{'off'}   'on'
Transfer Fcn Real Zero (Transfer Fcn Real Zero) (masked subsystem)		
ZeroZ	Zero (in Z plane)	string {'0.75'}
ICPrevInput	Initial condition for previous input	string {'0.0'}
RndMeth	Round toward	'Zero'   'Nearest'   'Ceiling'   {'Floor'}
DoSatur	Saturate to max or min when overflows occur	{'off'}   'on'
Unit Delay (UnitDelay)		
X0	Initial condition	scalar or vector {'0'}
SampleTime	Sample time (-1 for inherited)	string {'1'}

**Discrete Library Block Parameters (Continued)**

<b>Block (Type)/Parameter</b>	<b>Dialog Box Prompt</b>	<b>Values</b>
StateIdentifier	State name	string {}
StateMustResolveToSignalObject	State name must resolve to Simulink signal object	{'off'}   'on'
RTWStateStorageClass	RTW storage class	{'Auto'}   'ExportedGlobal'   'ImportedExtern'   'ImportedExternPointer'
RTWStateStorageTypeQualifier	RTW storage type qualifier	string {}
<b>Weighted Moving Average (S-Function) (Weighted Moving Average) (masked subsystem)</b>		
mgainval	Weights	string {'[0.1:0.1:1 0.9:-0.1:0.1]'} 
vinit	Initial condition	string {'0.0'}
samptime	Sample time	string {'-1'}
OutDataTypeStr	Output data type	string {'Inherit: Inherit via internal rule'}   'Inherit: Inherit via back propagation'
OutputDataTypeScalingMode	Deprecated	
OutDataType	Deprecated	
OutScaling	Deprecated	
LockScale	Lock output scaling against changes by the autoscaling tool	{'off'}   'on'
RndMeth	Round toward	'Zero'   'Nearest'   'Ceiling'   {'Floor'}
DoSatur	Saturate to max or min when overflows occur	{'off'}   'on'

**Discrete Library Block Parameters (Continued)**

<b>Block (Type)/Parameter</b>	<b>Dialog Box Prompt</b>	<b>Values</b>
GainDataTypeStr	Gain data type	string {'Inherit: Inherit via internal rule'}
GainDataTypeScalingMode	Deprecated	
GainDataType	Deprecated	
MatRadixGroup	Deprecated	
GainScaling	Deprecated	
Zero-Order Hold (ZeroOrderHold)		
SampleTime	Sample time (-1 for inherited)	string {'1'}

**Logic and Bit Operations Library Block Parameters**

<b>Block (Type)/Parameter</b>	<b>Dialog Box Prompt</b>	<b>Values</b>
Bit Clear (Bit Clear) (masked subsystem)		
iBit	Index of bit (0 is least significant)	string {'0'}
Bit Set (Bit Set) (masked subsystem)		
iBit	Index of bit (0 is least significant)	string {'0'}
Bitwise Operator (S-Function) (Bitwise Operator) (masked subsystem)		
logicop	Operator	{ 'AND'   'OR'   'NAND'   'NOR'   'XOR'   'NOT' }
UseBitMask	Use bit mask ...	'off'   {'on'}
NumInputPorts	Number of input ports	string {'1'}
BitMask	Bit mask	string {'bin2dec('11011001')'}
BitMaskRealWorld	Treat mask as	'Real World Value'   {'Stored Integer'}
Combinatorial Logic (CombinatorialLogic)		



**Logic and Bit Operations Library Block Parameters (Continued)**

<b>Block (Type)/Parameter</b>	<b>Dialog Box Prompt</b>	<b>Values</b>
TruthTable	Truth table	string { '[0 0;0 1;0 1;1 0;0 1;1 0;1 0;1 1]' }
SampleTime	Sample time (-1 for inherited)	string { '-1' }
Compare To Constant (Compare To Constant) (masked subsystem)		
relop	Operator	'=='   '~='   '<'   { '<=' }   '>'   '>'
const	Constant value	string { '3.0' }
LogicOutDataTypeMode	Output data type mode	{ 'uint8' }   'boolean'
ZeroCross	Enable zero crossing detection	{ 'off' }   'on'
Compare To Zero (Compare To Zero) (masked subsystem)		
relop	Operator	'=='   '~='   '<'   { '<=' }   '>'   '>'
LogicOutDataTypeMode	Output data type mode	{ 'uint8' }   'boolean'
ZeroCross	Enable zero crossing detection	{ 'off' }   'on'
Detect Change (Detect Change) (masked subsystem)		
vinit	Initial condition	string { '0' }
Detect Decrease (Detect Decrease) (masked subsystem)		
vinit	Initial condition	string { '0.0' }
Detect Fall Negative (Detect Fall Negative) (masked subsystem)		
vinit	Initial condition	string { '0' }
Detect Fall Nonpositive (Detect Fall Nonpositive) (masked subsystem)		
vinit	Initial condition	string { '0' }
Detect Increase (Detect Increase) (masked subsystem)		
vinit	Initial condition	string { '0.0' }
Detect Rise Nonnegative (Detect Rise Nonnegative) (masked subsystem)		
vinit	Initial condition	string { '0' }

**Logic and Bit Operations Library Block Parameters (Continued)**

<b>Block (Type)/Parameter</b>	<b>Dialog Box Prompt</b>	<b>Values</b>
Detect Rise Positive (Detect Rise Positive) (masked subsystem)		
vinit	Initial condition	string {'0'}
Extract Bits (Extract Bits) (masked subsystem)		
bitsToExtract	Bits to extract	{'Upper half'   'Lower half'   'Range starting with most   significant bit'   'Range ending with least significant bit'   'Range of bits'}
numBits	Number of bits	string {'8'}
bitIdxRange	Bit indices ([start end], 0-based relative to LSB)	string {'[0 7]'}
outScalingMode	Output scaling mode	{'Preserve fixed-point scaling'   'Treat bit field as an integer'}
Interval Test (Interval Test) (masked subsystem)		
IntervalClosedRight	Interval closed on right	'off'   {'on'}
uplimit	Upper limit	string {'0.5'}
IntervalClosedLeft	Interval closed on left	'off'   {'on'}
lowlimit	Lower limit	string {'-0.5'}
LogicOutDataTypeMode	Output data type mode	'uint8'   {'boolean'}
Interval Test Dynamic (Interval Test Dynamic) (masked subsystem)		
IntervalClosedRight	Interval closed on right	'off'   {'on'}
IntervalClosedLeft	Interval closed on left	'off'   {'on'}
LogicOutDataTypeMode	Output data type mode	'uint8'   {'boolean'}
Logical Operator (Logic)		
Operator	Operator	{'AND'   'OR'   'NAND'   'NOR'   'XOR'   'NOT'}

**Logic and Bit Operations Library Block Parameters (Continued)**

<b>Block (Type)/Parameter</b>	<b>Dialog Box Prompt</b>	<b>Values</b>
Inputs	Number of input ports	string {'2'}
IconShape	Icon shape	{'rectangular'}   'distinctive'
AllPortsSameDT	Require all inputs and output to have the same data type	{'off'}   'on'
OutDataTypeStr	Output data type	string 'Inherit: Logical (see Configuration Parameters: Optimization)'   {'boolean'}
SampleTime	Sample time (-1 for inherited)	string {'-1'}
<b>Relational Operator (RelationalOperator)</b>		
Operator	Relational operator	'=='   '~='   '<'   {'<='}   '>='   '>'
InputSameDT	Require all inputs to have the same data type	{'off'}   'on'
OutDataTypeStr	Output data type	string 'Inherit: Logical (see Configuration Parameters: Optimization)'   {'boolean'}
ZeroCross	Enable zero crossing detection	'off'   {'on'}
SampleTime	Sample time (-1 for inherited)	string {'-1'}
<b>Shift Arithmetic (Shift Arithmetic) (masked subsystem)</b>		
nBitShiftRight	Number of bits to shift right (use negative value to shift left)	string {'0'}
nBinPtShiftRight	Number of places by which binary point shifts right (use negative value to shift left)	string {'0'}

### Lookup Tables Block Parameters

Block (Type)/Parameter	Dialog Box Prompt	Values
Cosine (Cosine) (masked subsystem)		
Formula	Output formula	'sin(2*pi*u)'   {'cos(2*pi*u)'}   'exp(j*2*pi*u)'   'sin(2*pi*u) and cos(2*pi*u)'
NumDataPoints	Number of data points for lookup table	string {'(2^5)+1'}
OutputWordLength	Output word length	string {'16'}
Direct Lookup Table (n-D) (S-Function) (LookupNDDirect) (masked subsystem)		
maskTabDims	Number of table dimensions	'1'   {'2'}   '3'   '4'   'More...'
explicitNumDims	Explicit number of table dimensions	string {'1'}
outDims	Inputs select this object from table	{'Element'}   'Column'   '2-D Matrix'
tabIsInput	Make table an input	{'off'}   'on'
mxTable	Table data	string {'[4 5 6;16 19 20;10 18 23]'}
clipFlag	Action for out of range input	'None'   {'Warning'}   'Error'
samptime	Sample time	string {'-1'}
Interpolation Using Prelookup (Interpolation_n-D)		
NumberOfTableDimensions	Number of table dimensions	string {'2'}
Table	Table data	string {'sqrt([1:11]' * [1:11])'}
InterpMethod	Interpolation method	'None - Flat'   {'Linear'}
ExtrapMethod	Extrapolation method	'None - Clip'   {'Linear'}

**Lookup Tables Block Parameters (Continued)**

<b>Block (Type)/Parameter</b>	<b>Dialog Box Prompt</b>	<b>Values</b>
RangeErrorMode	Action for out of range input	{'None'}   'Warning'   'Error'
CheckIndexInCode	Check index in generated code	{'on'}   'off'
ValidIndexMayReachLast	Valid index input may reach last index	'on'   {'off'}
NumSelectionDims	Number of sub-table selection dimensions	string {'0'}
OutMin	Output minimum	string {'[]'}
OutMax	Output maximum	string {'[]'}
OutDataTypeStr	Output data type	string 'Inherit: Inherit via back propagation'   {'Inherit: Inherit from table data'}   'double'   'single'   'int8'   'uint8'   'int16'   'uint16'   'int32'   'uint32'
LockScale	Lock output scaling against changes by the autoscaling tool	'on'   {'off'}
RndMeth	Round integer calculations toward	'Zero'   'Nearest'   'Ceiling'   {'Floor'}   'Simplest'
SampleTime	Sample time (-1 for inherited)	string {'-1'}
<b>Lookup Table (Lookup)</b>		
InputValues	Vector of input values	vector {'[-5:5]'}
Table	Table data	vector {'tanh([-5:5])'}

**Lookup Tables Block Parameters (Continued)**

<b>Block (Type)/Parameter</b>	<b>Dialog Box Prompt</b>	<b>Values</b>
LookUpMeth	Lookup method	{'Interpolation-Extrapolation'   'Interpolation-Use End Values'   'Use Input Nearest'   'Use Input Below'   'Use Input Above'}
OutMin	Output minimum	string {'[]'}
OutMax	Output maximum	string {'[]'}
OutDataTypeStr	Output data type	string 'Inherit: Inherit via back propagation'   {'Inherit: Same as input'   'double'   'single'   'int8'   'uint8'   'int16'   'uint16'   'int32'   'uint32'}
LockScale	Lock output scaling against changes by the autoscaling tool	{'off'}   'on'
RndMeth	Round integer calculations toward	'Zero'   'Nearest'   'Ceiling'   {'Floor'}   'Simplest'
SaturateOnInteger Overflow	Saturate on integer overflow	{'off'}   'on'
SampleTime	Sample time (-1 for inherited)	string {'-1'}
Lookup Table (2-D) (Lookup2D)		
RowIndex	Row index input values	string {'[1:3]'}
ColumnIndex	Column index input values	string {'[1:3]'}
Table	Table data	string {'[4 5 6;16 19 20;10 18 23]'}

**Lookup Tables Block Parameters (Continued)**

<b>Block (Type)/Parameter</b>	<b>Dialog Box Prompt</b>	<b>Values</b>
LookUpMeth	Lookup method	{'Interpolation-Extrapolation'   'Interpolation-Use End Values'   'Use Input Nearest'   'Use Input Below'   'Use Input Above'}
InputSameDT	Require all inputs to have the same data type	'on'   {'off'}
OutMin	Output minimum	string {'[]'}
OutMax	Output maximum	string {'[]'}
OutDataTypeStr	Output data type	string 'Inherit: Inherit via back propagation'   {'Inherit: Same as first input'}   'double'   'single'   'int8'   'uint8'   'int16'   'uint16'   'int32'   'uint32'
LockScale	Lock output scaling against changes by the autoscaling tool	'on'   {'off'}
RndMeth	Round integer calculations toward	'Zero'   'Nearest'   'Ceiling'   {'Floor'}   'Simplest'
SaturateOnInteger Overflow	Saturate on integer overflow	'on'   {'off'}
SampleTime	Sample time (-1 for inherited)	string {'-1'}
Lookup Table (n-D) (Lookup_n-D)		
NumberOfTableDimensions	Number of table dimensions	string {'2'}
BreakpointsForDimension1	Breakpoints for dimension 1	string {'[10,22,31]'}

**Lookup Tables Block Parameters (Continued)**

<b>Block (Type)/Parameter</b>	<b>Dialog Box Prompt</b>	<b>Values</b>
BreakpointsForDimension2	Breakpoints for dimension 2	string {'[10,22,31]'}
BreakpointsForDimension3	Breakpoints for dimension 3	string {'[1:3]'}
BreakpointsForDimension4	Breakpoints for dimension 4	string {'[1:3]'}
BreakpointsForDimension5	Breakpoints for dimension 5	string {'[1:3]'}
IndexSearchMethod	Index search method	'Evenly spaced points'   'Linear search'   {'Binary search'}
BeginIndexSearchUsing PreviousIndexResult	Begin index search using previous index result	'on'   {'off'}
UseOneInputPortForAll InputData	Use one input port for all input data	'on'   {'off'}
Table	Table data	string {'[4 5 6;16 19 20;10 18 23]'}
InterpMethod	Interpolation method	'None - Flat'   {'Linear'}   'Cubic spline'
ExtrapMethod	Extrapolation method	'None - Clip'   {'Linear'}   'Cubic spline'
ProcessOutOfRangeInput	Process out-of-range input	{'None'}   'Warning'   'Error'
UseLastTableValue	Use last table value for inputs at or above last breakpoint	'on'   {'off'}
SampleTime	Sample time (-1 for inherited)	string {'-1'}
Lookup Table Dynamic (Lookup Table Dynamic) (masked subsystem)		



**Lookup Tables Block Parameters (Continued)**

<b>Block (Type)/Parameter</b>	<b>Dialog Box Prompt</b>	<b>Values</b>
LookUpMeth	Lookup Method	'Interpolation-Extrapolation'   {'Interpolation-Use End Values'}   'Use Input Nearest'   'Use Input Below'   'Use Input Above'
OutDataTypeStr	Output data type	string {'float('double')'}   'Inherit: Inherit via back propagation'
OutputDataTypeScaling Mode	Deprecated	
OutDataType	Deprecated	
OutScaling	Deprecated	
LockScale	Lock output scaling against changes by the autoscaling tool	'on'   {'off'}
RndMeth	Round toward	'Zero'   'Nearest'   'Ceiling'   {'Floor'}   Simplest
DoSatur	Saturate to max or min when overflows occur	'on'   {'off'}
Prelookup (PreLookup)		
BreakpointsData	Breakpoint data	string {'[10:10:110]'}
IndexSearchMethod	Index search method	'Evenly spaced points'   'Linear search'   {'Binary search'}
BeginIndexSearchUsing PreviousIndexResult	Begin index search using previous index result	'on'   {'off'}
OutputOnlyTheIndex	Output only the index	'on'   {'off'}
ProcessOutOfRangeInput	Process out-of-range input	'Clip to range'   {'Linear extrapolation'}

**Lookup Tables Block Parameters (Continued)**

<b>Block (Type)/Parameter</b>	<b>Dialog Box Prompt</b>	<b>Values</b>
UseLastBreakpoint	Use last breakpoint for input at or above upper limit	'on'   {'off'}
ActionForOutOfRangeInput	Action for out of range input	{'None'}   'Warning'   'Error'
SampleTime	Sample time (-1 for inherited)	string {'-1'}
OutDataTypeStr	Index data type	string 'int8'   'uint8'   'int16'   'uint16'   'int32'   {'uint32'}
Out2DataTypeStr	Fraction data type	string {'Inherit: Inherit via internal rule'}   'double'   'single'
LockScale	Lock output scaling against changes by the autoscaling tool	'on'   {'off'}
RndMeth	Round integer calculations toward	'Zero'   'Nearest'   'Ceiling'   {'Floor'}   'Simplest'
Sine (Sine) (masked subsystem)		
Formula	Output formula	{'sin(2*pi*u)'}   'cos(2*pi*u)'   'exp(j*2*pi*u)'   'sin(2*pi*u) and cos(2*pi*u)'

**Lookup Tables Block Parameters (Continued)**

Block (Type)/Parameter	Dialog Box Prompt	Values
NumDataPoints	Number of data points for lookup table	string $\{(2^5)+1\}$
OutputWordLength	Output word length	string $\{16\}$

**Math Operations Library Block Parameters**

Block (Type)/Parameter	Dialog Box Prompt	Values
Abs (Abs)		
ZeroCross	Enable zero crossing detection	<code>'on'</code>   <code>'off'</code>
SampleTime	Sample time (-1 for inherited)	string $\{-1\}$
OutMax	Output maximum	string $\{[]\}$
OutDataTypeStr	Output data type	string 'Inherit: Inherit via internal rule'   'Inherit: Inherit via back propagation'   <code>{'Inherit: Same as input'}</code>   <code>'double'</code>   <code>'single'</code>   <code>'int8'</code>   <code>'uint8'</code>   <code>'int16'</code>   <code>'uint16'</code>   <code>'int32'</code>   <code>'uint32'</code>
LockScale	Lock output scaling against changes by the autoscaling tool	<code>'on'</code>   <code>{'off'}</code>
RndMeth	Round integer calculations toward	<code>'Zero'</code>   <code>'Nearest'</code>   <code>'Ceiling'</code>   <code>{'Floor'}</code>
SaturateOnInteger Overflow	Saturate on integer overflow	<code>'on'</code>   <code>{'off'}</code>
Add (Sum)		
IconShape	Icon shape	<code>{'rectangular'}</code>   <code>'round'</code>

**Math Operations Library Block Parameters (Continued)**

<b>Block (Type)/Parameter</b>	<b>Dialog Box Prompt</b>	<b>Values</b>
Inputs	List of signs	string {'++'}
CollapseMode	Sum over	{'All dimensions'}   'Specified dimension'
CollapseDim	Dimension	string {'1'}
InputSameDT	Require all inputs to have the same data type	'on'   {'off'}
OutMin	Output minimum	string {'[]'}
OutMax	Output maximum	string {'[]'}
OutDataTypeStr	Output data type	string {'Inherit: Inherit via internal rule'}   'Inherit: Inherit via back propagation'   'Inherit: Same as first input'   'double'   'single'   'int8'   'uint8'   'int16'   'uint16'   'int32'   'uint32'
LockScale	Lock output scaling against changes by the autoscaling tool	'on'   {'off'}
RndMeth	Round integer calculations toward	'Zero'   'Nearest'   'Ceiling'   {'Floor'}
SaturateOnInteger Overflow	Saturate on integer overflow	'on'   {'off'}
SampleTime	Sample time (-1 for inherited)	string {'-1'}
Algebraic Constraint (Algebraic Constraint) (masked subsystem)		
z0	Initial guess	string {'0'}
Assignment (Assignment)		
NumberOfDimensions	Number of input dimensions	string {'1'}

**Math Operations Library Block Parameters (Continued)**

<b>Block (Type)/Parameter</b>	<b>Dialog Box Prompt</b>	<b>Values</b>
IndexMode	Index mode	'Zero-based'   {'One-based'}
OutputInitialize	Initialize output (Y)	{'Initialize using input port <Y0>'}   'Specify size for each dimension in table'
IndexOptionArray	Index Option	'Assign all'   {'Index vector (dialog)'}   'Index vector (port)'   'Starting index (dialog)'   'Starting index (port)'
IndexParamArray	Index	cell array
OutputSizeArray	Output Size	cell array
DiagnosticForDimensions	Action if any output element is not assigned	'Error'   'Warning'   {'None'}
SampleTime	Sample time (-1 for inherited)	string {'-1'}
IndexOptions	See IndexOptionArray parameter for more information.	
Indices	See IndexParamArray parameter for more information.	
OutputSizes	See OutputSizeArray parameter for more information.	
<b>Bias (Bias)</b>		
Bias	Bias	string {'0.0'}
SaturateOnInteger Overflow	Saturate on integer overflow	'on'   {'off'}
<b>Complex to Magnitude-Angle (ComplexToMagnitudeAngle)</b>		

**Math Operations Library Block Parameters (Continued)**

<b>Block (Type)/Parameter</b>	<b>Dialog Box Prompt</b>	<b>Values</b>
Output	Output	'Magnitude'   'Angle'   {'Magnitude and angle'}
SampleTime	Sample time (-1 for inherited)	string {'-1'}
<b>Complex to Real-Imag (ComplexToRealImag)</b>		
Output	Output	'Real'   'Imag'   {'Real and imag'}
SampleTime	Sample time (-1 for inherited)	string {'-1'}
<b>Divide (Product)</b>		
Inputs	Number of inputs	string {'*/'}
Multiplication	Multiplication	{'Element-wise(.*)'}   'Matrix(*)'
InputSameDT	Require all inputs to have same data type	'on'   {'off'}
OutMin	Output minimum	string {'[]'}
OutMax	Output maximum	string {'[]'}
OutDataTypeStr	Output data type	string {'Inherit: Inherit via internal rule'}   'Inherit: Inherit via back propagation'   'Inherit: Same as first input'   'double'   'single'   'int8'   'uint8'   'int16'   'uint16'   'int32'   'uint32'
LockScale	Lock output scaling against changes by the autoscaling tool	'on'   {'off'}

**Math Operations Library Block Parameters (Continued)**

<b>Block (Type)/Parameter</b>	<b>Dialog Box Prompt</b>	<b>Values</b>
RndMeth	Round integer calculations toward	'Zero'   'Nearest'   'Ceiling'   {'Floor'}   'Simplest'
SaturateOnInteger Overflow	Saturate on integer overflow	'on'   {'off'}
SampleTime	Sample time (-1 for inherited)	string {'-1'}
<b>Dot Product (Dot Product) (masked subsystem)</b>		
InputSameDT	Require all inputs to have same data type	{'on'}   'off'
OutDataTypeStr	Output data type	string {'Inherit: Inherit via internal rule'}   'Inherit: Inherit via back propagation'   'Inherit: Same as first input'
OutputDataTypeScaling Mode	Deprecated	
OutDataType	Deprecated	
OutScaling	Deprecated	
LockScale	Lock output scaling against changes by the autoscaling tool	'on'   {'off'}
RndMeth	Round integer calculation toward	'Zero'   'Nearest'   'Ceiling'   {'Floor'}
DoSatur	Saturate on integer overflow	'on'   {'off'}
<b>Gain (Gain)</b>		
Gain	Gain	string {'1'}

**Math Operations Library Block Parameters (Continued)**

<b>Block (Type)/Parameter</b>	<b>Dialog Box Prompt</b>	<b>Values</b>
Multiplication	Multiplication	{'Element-wise(K.*u)'}   'Matrix(K*u)'   'Matrix(u*K)'   'Matrix(K*u) (u vector)'
ParamMin	Parameter minimum	string {'[]'}
ParamMax	Parameter maximum	string {'[]'}
ParamDataTypeStr	Parameter data type	string {'Inherit: Inherit via internal rule'}   'Inherit: Same as input'   'double'   'single'   'int8'   'uint8'   'int16'   'uint16'   'int32'   'uint32'
OutMin	Output minimum	string {'[]'}
OutMax	Output maximum	string {'[]'}
OutDataTypeStr	Output data type	string {'Inherit: Inherit via internal rule'}   'Inherit: Inherit via back propagation'   'Inherit: Same as input'   'double'   'single'   'int8'   'uint8'   'int16'   'uint16'   'int32'   'uint32'
LockScale	Lock output scaling against changes by the autoscaling tool	'on'   {'off'}
RndMeth	Round integer calculations toward	'Zero'   'Nearest'   'Ceiling'   {'Floor'}
SaturateOnInteger Overflow	Saturate on integer overflow	'on'   {'off'}



**Math Operations Library Block Parameters (Continued)**

<b>Block (Type)/Parameter</b>	<b>Dialog Box Prompt</b>	<b>Values</b>
SampleTime	Sample time (-1 for inherited)	string {'-1'}
Magnitude-Angle to Complex (MagnitudeAngleToComplex)		
Input	Input	'Magnitude'   'Angle'   {'Magnitude and angle'}
ConstantPart		string {'0'}
SampleTime	Sample time (-1 for inherited)	string {'-1'}
Math Function (Math)		
Operator	Function	{'exp'}   'log'   '10^u'   'log10'   'magnitude^2'   'square'   'sqrt'   'pow'   'conj'   'reciprocal'   'hypot'   'rem'   'mod'   'transpose'   'hermitian'
OutputSignalType	Output signal type	{'auto'}   'real'   'complex'
SampleTime	Sample time (-1 for inherited)	string {'-1'}
OutMin	Output minimum	string {'[]'}
OutMax	Output maximum	string {'[]'}
OutDataTypeStr	Output data type	string 'Inherit: Inherit via internal rule'   'Inherit: Inherit via back propagation'   {'Inherit: Same as first input'}   'double'   'single'   'int8'   'uint8'   'int16'   'uint16'   'int32'   'uint32'

**Math Operations Library Block Parameters (Continued)**

<b>Block (Type)/Parameter</b>	<b>Dialog Box Prompt</b>	<b>Values</b>
LockScale	Lock output scaling against changes by the autoscaling tool	'on'   {'off'}
RndMeth	Round integer calculations toward	'Zero'   'Nearest'   'Ceiling'   {'Floor'}
SaturateOnInteger Overflow	Saturate on integer overflow	{'on'}   'off'
<b>Matrix Concatenate (Concatenate)</b>		
NumInputs	Number of inputs	string {'2'}
Mode	Mode	'Vector'   {'Multidimensional array'}
ConcatenateDimension	Concatenate dimension	string {'2'}
<b>MinMax (MinMax)</b>		
Function	Function	{'min'}   'max'
Inputs	Number of input ports	string {'1'}
InputSameDT	Require all inputs to have the same data type	'on'   {'off'}
OutMin	Output minimum	string {'[]'}
OutMax	Output maximum	string {'[]'}
OutDataTypeStr	Output data type	string {'Inherit: Inherit via internal rule'}   'Inherit: Inherit via back propagation'   'double'   'single'   'int8'   'uint8'   'int16'   'uint16'   'int32'   'uint32'

**Math Operations Library Block Parameters (Continued)**

<b>Block (Type)/Parameter</b>	<b>Dialog Box Prompt</b>	<b>Values</b>
LockScale	Lock output scaling against changes by the autoscaling tool	'on'   {'off'}
RndMeth	Round integer calculations toward	'Zero'   'Nearest'   'Ceiling'   {'Floor'}
SaturateOnInteger Overflow	Saturate on integer overflow	'on'   {'off'}
ZeroCross	Enable zero crossing detection	{'on'}   'off'
SampleTime	Sample time (-1 for inherited)	string {'-1'}
MinMax Running Resettable (MinMax Running Resettable) (masked subsystem)		
Function	Function	{'min'}   'max'
vinit	Initial condition	string {'0.0'}
Permute Dimensions (Permute Dimensions) (masked subsystem)		
Order	Order	string {'[]'}
Polynomial (Polyval) (masked subsystem)		
coefs	Polynomial coefficients	string {'[ +2.081618890e-019, -1.441693666e-014, +4.719686976e-010, -8.536869453e-006, +1.621573104e-001, -8.087801117e+001 ]'}
Product (Product)		
Inputs	Number of inputs	string {'2'}
Multiplication	Multiplication	{'Element-wise(.*)'}   'Matrix(*)'
CollapseMode	Multiply over	{'All dimensions'}   'Specified dimension'
CollapseDim	Dimension	string {'1'}

**Math Operations Library Block Parameters (Continued)**

<b>Block (Type)/Parameter</b>	<b>Dialog Box Prompt</b>	<b>Values</b>
InputSameDT	Require all inputs to have same data type	'on'   {'off'}
OutMin	Output minimum	string {'[]'}
OutMax	Output maximum	string {'[]'}
OutDataTypeStr	Output data type	string {'Inherit: Inherit via internal rule'   'Inherit: Inherit via back propagation'   'Inherit: Same as first input'   'double'   'single'   'int8'   'uint8'   'int16'   'uint16'   'int32'   'uint32'}
LockScale	Lock output scaling against changes by the autoscaling tool	'on'   {'off'}
RndMeth	Round integer calculations toward	{'Zero'}   'Nearest'   'Ceiling'   'Floor'   'Simplest'
SaturateOnInteger Overflow	Saturate on integer overflow	'on'   {'off'}
SampleTime	Sample time (-1 for inherited)	string {'-1'}
<b>Product of Elements (Product)</b>		
Inputs	Number of inputs	string {'*'}
Multiplication	Multiplication	{'Element-wise(*)'}   'Matrix(*)'
CollapseMode	Multiply over	{'All dimensions'}   'Specified dimension'
CollapseDim	Dimension	string {'1'}

**Math Operations Library Block Parameters (Continued)**

<b>Block (Type)/Parameter</b>	<b>Dialog Box Prompt</b>	<b>Values</b>
InputSameDT	Require all inputs to have same data type	'on'   {'off'}
OutMin	Output minimum	string {'[[']}
OutMax	Output maximum	string {'[[']}
OutDataTypeStr	Output data type	string {'Inherit: Inherit via internal rule'   'Inherit: Inherit via back propagation'   'Inherit: Same as first input'   'double'   'single'   'int8'   'uint8'   'int16'   'uint16'   'int32'   'uint32'}
LockScale	Lock output scaling against changes by the autoscaling tool	'on'   {'off'}
RndMeth	Round integer calculations toward	'Zero'   'Nearest'   'Ceiling'   {'Floor'}   'Simplest'
SaturateOnInteger Overflow	Saturate on integer overflow	'on'   {'off'}
SampleTime	Sample time (-1 for inherited)	string {'-1'}
<b>Real-Imag to Complex (RealImagToComplex)</b>		
Input	Input	'Real'   'Imag'   {'Real and imag'}
ConstantPart		string {'0'}
SampleTime	Sample time (-1 for inherited)	string {'-1'}
<b>Reshape (Reshape) (masked subsystem)</b>		



**Math Operations Library Block Parameters (Continued)**

<b>Block (Type)/Parameter</b>	<b>Dialog Box Prompt</b>	<b>Values</b>
gain	Gain	string {'1'}
high	High	string {'2'}
Squeeze (Squeeze) (masked subsystem)		
None	None	None
Subtract (Sum)		
IconShape	Icon shape	{'rectangular'}   'round'
Inputs	List of signs	string {'+-'}
CollapseMode	Sum over	{'All dimensions'}   'Specified dimension'
CollapseDim	Dimension	string {'1'}
InputSameDT	Require all inputs to have the same data type	'on'   {'off'}
OutMin	Output minimum	string {'[]'}
OutMax	Output maximum	string {'[]'}
OutDataTypeStr	Output data type	string {'Inherit: Inherit via internal rule'}   'Inherit: Inherit via back propagation'   'Inherit: Same as first input'   'double'   'single'   'int8'   'uint8'   'int16'   'uint16'   'int32'   'uint32'
LockScale	Lock output scaling against changes by the autoscaling tool	'on'   {'off'}
RndMeth	Round integer calculations toward	'Zero'   'Nearest'   'Ceiling'   {'Floor'}

**Math Operations Library Block Parameters (Continued)**

<b>Block (Type)/Parameter</b>	<b>Dialog Box Prompt</b>	<b>Values</b>
SaturateOnInteger Overflow	Saturate on integer overflow	'on'   {'off'}
SampleTime	Sample time (-1 for inherited)	string {'-1'}
Sum (Sum)		
IconShape	Icon shape	'rectangular'   {'round'}
Inputs	List of signs	string {' ++'}
CollapseMode	Sum over	{'All dimensions'}   'Specified dimension'
CollapseDim	Dimension	string {'1'}
InputSameDT	Require all inputs to have the same data type	'on'   {'off'}
OutMin	Output minimum	string {'[]'}
OutMax	Output maximum	string {'[]'}
OutDataTypeStr	Output data type	string {'Inherit: Inherit via internal rule'}   'Inherit: Inherit via back propagation'   'Inherit: Same as first input'   'double'   'single'   'int8'   'uint8'   'int16'   'uint16'   'int32'   'uint32'
LockScale	Lock output scaling against changes by the autoscaling tool	'on'   {'off'}
RndMeth	Round integer calculations toward	'Zero'   'Nearest'   'Ceiling'   {'Floor'}
SaturateOnInteger Overflow	Saturate on integer overflow	'on'   {'off'}



**Math Operations Library Block Parameters (Continued)**

<b>Block (Type)/Parameter</b>	<b>Dialog Box Prompt</b>	<b>Values</b>
SampleTime	Sample time (-1 for inherited)	string {'-1'}
Sum of Elements (Sum)		
IconShape	Icon shape	{'rectangular'}   'round'
Inputs	List of signs	string {'+'}
CollapseMode	Sum over	{'All dimensions'}   'Specified dimension'
CollapseDim	Dimension	string {'1'}
InputSameDT	Require all inputs to have the same data type	'on'   {'off'}
OutMin	Output minimum	string {'[]'}
OutMax	Output maximum	string {'[]'}
OutDataTypeStr	Output data type	string {'Inherit: Inherit via internal rule'}   'Inherit: Inherit via back propagation'   'Inherit: Same as first input'   'double'   'single'   'int8'   'uint8'   'int16'   'uint16'   'int32'   'uint32'
LockScale	Lock output scaling against changes by the autoscaling tool	'on'   {'off'}
RndMeth	Round integer calculations toward	'Zero'   'Nearest'   'Ceiling'   {'Floor'}
SaturateOnInteger Overflow	Saturate on integer overflow	'on'   {'off'}
SampleTime	Sample time (-1 for inherited)	string {'-1'}

**Math Operations Library Block Parameters (Continued)**

Block (Type)/Parameter	Dialog Box Prompt	Values
Trigonometric Function (Trigonometry)		
Operator	Function	{'sin'}   {'cos'}   {'tan'}   {'asin'}   {'acos'}   {'atan'}   {'atan2'}   {'sinh'}   {'cosh'}   {'tanh'}   {'asinh'}   {'acosh'}   {'atanh'}
OutputSignalType	Output signal type	{'auto'}   {'real'}   {'complex'}
SampleTime	Sample time (-1 for inherited)	string {'-1'}
Unary Minus (Unary Minus) (masked subsystem)		
DoSatur	Saturate to max or min when overflows occur	'on'   {'off'}
Vector Concatenate (Concatenate)		
NumInputs	Number of inputs	string {'2'}
Mode	Mode	{'Vector'}   'Multidimensional array'
Weighted Sample Time Math (Sample Time Math) (masked subsystem)		
TsampMathOp	Operation	{'+'}   {'-'}   {'*'}   {'/'}   'Ts Only'   '1/Ts Only'
weightValue	Weight value	string {'1.0'}
TsampMathImp	Implement using	{'Online Calculations'}   'Offline Scaling Adjustment'
OutputDataTypeScaling Mode	Output data type and scaling	{'Inherit via internal rule'}   'Inherit via back propagation'

**Math Operations Library Block Parameters (Continued)**

Block (Type)/Parameter	Dialog Box Prompt	Values
RndMeth	Round toward	'Zero'   'Nearest'   'Ceiling'   {'Floor'}
DoSatur	Saturate to max or min when overflows occur	'on'   {'off'}

**Model Verification Library Block Parameters**

Block (Type)/Parameter	Dialog Box Prompt	Values
Assertion (Assertion)		
Enabled	Enable assertion	{'on'}   'off'
AssertionFailFcn	Simulation callback when assertion fails	string {''}
StopWhenAssertionFail	Stop simulation when assertion fails	{'on'}   'off'
SampleTime	Sample time (-1 for inherited)	string {'-1'}
Check Discrete Gradient (Checks_Gradient) (masked subsystem)		
gradient	Maximum gradient	string {'1'}
enabled	Enable assertion	{'on'}   'off'
callback	Simulation callback when assertion fails (optional)	string {''}
stopWhenAssertionFail	Stop simulation when assertion fails	{'on'}   'off'
export	Output assertion signal	'on'   {'off'}
icon	Select icon type	{'graphic'}   'text'
Check Dynamic Gap (Checks_DGap) (masked subsystem)		
enabled	Enable assertion	{'on'}   'off'
callback	Simulation callback when assertion fails (optional)	string {''}

**Model Verification Library Block Parameters (Continued)**

<b>Block (Type)/Parameter</b>	<b>Dialog Box Prompt</b>	<b>Values</b>
stopWhenAssertionFail	Stop simulation when assertion fails	{'on'}   'off'
export	Output assertion signal	'on'   {'off'}
icon	Select icon type	{'graphic'}   'text'
Check Dynamic Lower Bound (Checks_DMin) (masked subsystem)		
Enabled	Enable assertion	{'on'}   'off'
callback	Simulation callback when assertion fails (optional)	string {''}
stopWhenAssertionFail	Stop simulation when assertion fails	{'on'}   'off'
export	Output assertion signal	'on'   {'off'}
icon	Select icon type	{'graphic'}   'text'
Check Dynamic Range (Checks_DRange) (masked subsystem)		
enabled	Enable assertion	{'on'}   'off'
callback	Simulation callback when assertion fails (optional)	string {''}
stopWhenAssertionFail	Stop simulation when assertion fails	{'on'}   'off'
export	Output assertion signal	'on'   {'off'}
icon	Select icon type	{'graphic'}   'text'
Check Dynamic Upper Bound (Checks_DMax) (masked subsystem)		
enabled	Enable assertion	{'on'}   'off'
callback	Simulation callback when assertion fails (optional)	string {''}
stopWhenAssertionFail	Stop simulation when assertion fails	{'on'}   'off'
export	Output assertion signal	'on'   {'off'}

**Model Verification Library Block Parameters (Continued)**

<b>Block (Type)/Parameter</b>	<b>Dialog Box Prompt</b>	<b>Values</b>
icon	Select icon type	{'graphic'}   'text'
Check Input Resolution (Checks_Resolution) (masked subsystem)		
resolution	Resolution	string {'1'}
enabled	Enable assertion	{'on'}   'off'
callback	Simulation callback when assertion fails (optional)	string {''}
stopWhenAssertionFail	Stop simulation when assertion fails	{'on'}   'off'
export	Output assertion signal	'on'   {'off'}
Check Static Gap (Checks_SGap) (masked subsystem)		
max	Upper bound	string {'100'}
max_included	Inclusive upper bound	{'on'}   'off'
min	Lower bound	string {'0'}
min_included	Inclusive lower bound	{'on'}   'off'
enabled	Enable assertion	{'on'}   'off'
callback	Simulation callback when assertion fails (optional)	string {''}
stopWhenAssertionFail	Stop simulation when assertion fails	{'on'}   'off'
export	Output assertion signal	'on'   {'off'}
icon	Select icon type	{'graphic'}   'text'
Check Static Lower Bound (Checks_SMin) (masked subsystem)		
min	Lower bound	string {'0'}
min_included	Inclusive boundary	{'on'}   'off'
enabled	Enable assertion	{'on'}   'off'

**Model Verification Library Block Parameters (Continued)**

<b>Block (Type)/Parameter</b>	<b>Dialog Box Prompt</b>	<b>Values</b>
callback	Simulation callback when assertion fails (optional)	string {''}
stopWhenAssertionFail	Stop simulation when assertion fails	{'on'}   'off'
export	Output assertion signal	'on'   {'off'}
icon	Select icon type	{'graphic'}   'text'
<b>Check Static Range (Checks_SRange) (masked subsystem)</b>		
max	Upper bound	string {'100'}
max_included	Inclusive upper bound	{'on'}   'off'
min	Lower bound	string {'0'}
min_included	Inclusive lower bound	{'on'}   'off'
enabled	Enable assertion	{'on'}   'off'
callback	Simulation callback when assertion fails (optional)	string {''}
stopWhenAssertionFail	Stop simulation when assertion fails	{'on'}   'off'
export	Output assertion signal	'on'   {'off'}
icon	Select icon type	{'graphic'}   'text'
<b>Check Static Upper Bound (Checks_SMax) (masked subsystem)</b>		
max	Upper bound	string {'0'}
max_included	Inclusive boundary	{'on'}   'off'
enabled	Enable assertion	{'on'}   'off'
callback	Simulation callback when assertion fails (optional)	string {''}
stopWhenAssertionFail	Stop simulation when assertion fails	{'on'}   'off'

**Model Verification Library Block Parameters (Continued)**

<b>Block (Type)/Parameter</b>	<b>Dialog Box Prompt</b>	<b>Values</b>
export	Output assertion signal	'on'   {'off'}
icon	Select icon type	{'graphic'}   'text'

**Model-Wide Utilities Library Block Parameters**

<b>Block (Type)/Parameter</b>	<b>Dialog Box Prompt</b>	<b>Values</b>
Block Support Table (Block Support Table) (masked subsystem)		
DocBlock (DocBlock) (masked subsystem)		
ECoderFlag	RTW Embedded Coder Flag	string {''}
DocumentType	Document Type	{'Text'}   'RTF'   'HTML'
Model Info (CMBlock) (masked subsystem)		
InitialSaveTempField	InitialSaveTempField	string {''}
InitialBlockCM	InitialBlockCM	string {'None'}
BlockCM	BlockCM	string {'None'}
Frame	Show block frame	string {'on'}
SaveTempField	SaveTempField	string {''}
DisplayStringWithTags	DisplayStringWithTags	string {'Model Info'}
MaskDisplayString	MaskDisplayString	string {'Model Info'}
HorizontalTextAlignment	Horizontal text alignment	string {'Center'}
LeftAlignmentValue	LeftAlignmentValue	string {'0.5'}
SourceBlockDiagram	SourceBlockDiagram	string {'untitled'}
TagMaxNumber	TagMaxNumber	string {'20'}
CMTag1	CMTag1	string {''}
CMTag2	CMTag2	string {''}
CMTag3	CMTag3	string {''}
CMTag4	CMTag4	string {''}

**Model-Wide Utilities Library Block Parameters (Continued)**

<b>Block (Type)/Parameter</b>	<b>Dialog Box Prompt</b>	<b>Values</b>
CMTag5	CMTag5	string {''}
CMTag6	CMTag6	string {''}
CMTag7	CMTag7	string {''}
CMTag8	CMTag8	string {''}
CMTag9	CMTag9	string {''}
CMTag10	CMTag10	string {''}
CMTag11	CMTag11	string {''}
CMTag12	CMTag12	string {''}
CMTag13	CMTag13	string {''}
CMTag14	CMTag14	string {''}
CMTag15	CMTag15	string {''}
CMTag16	CMTag16	string {''}
CMTag17	CMTag17	string {''}
CMTag18	CMTag18	string {''}
CMTag19	CMTag19	string {''}
CMTag20	CMTag20	string {''}
<b>Timed-Based Linearization (Timed Linearization) (masked subsystem)</b>		
LinearizationTime	Linearization time	string {'1'}
SampleTime	Sample time (of linearized model)	string {'0'}
<b>Trigger-Based Linearization (Triggered Linearization) (masked subsystem)</b>		



**Model-Wide Utilities Library Block Parameters (Continued)**

Block (Type)/Parameter	Dialog Box Prompt	Values
TriggerType	Trigger type	{'rising'}   'falling'   'either'   'function-call'
SampleTime	Sample time (of linearized model)	string {'0'}

**Ports & Subsystems Library Block Parameters**

Block (Type)/Parameter	Dialog Box Prompt	Values
Action Port (ActionPort)		
InitializeStates	Specifies how to handle internal states when the subsystem of this Action Port block is reenabled. Set by the <b>States when execution is resumed</b> control on the block's parameter dialog box.	{'held'}   'reset'
Atomic Subsystem (SubSystem)		
ShowPortLabels	Show port labels. The values 'on' and 'off' are for backward compatibility only and should not be used in new models or when updating existing models.	{'FromPortIcon'}   'FromPortBlockName'   'Signal Name'   'none'   'on'   'off'
BlockChoice	Block choice	{''}
TemplateBlock	Template block	string {''}
MemberBlocks	Member blocks	string {''}
Permissions	Read/Write permissions	{'ReadWrite'}   'ReadOnly'   'NoReadOrWrite'

## Ports &amp; Subsystems Library Block Parameters (Continued)

Block (Type)/Parameter	Dialog Box Prompt	Values
ErrorFcn	Name of error callback function	string {''}
PermitHierarchicalResolution	Permit hierarchical resolution	{'All'}   'ExplicitOnly'   'None'
TreatAsAtomicUnit	Treat as atomic unit	{'on'}   'off'
MinAlgLoopOccurrences	Minimize algebraic loop occurrences	'on'   {'off'}
PropExecContextOutsideSubsystem	Propagate execution context across subsystem boundary	{'on'}   'off'
CheckFcnCallInpInsideContextMsg	Warn if function-call inputs are context-specific	'on'   {'off'}
SystemSampleTime	Sample time (-1 for inherited)	string {'-1'}
RTWSystemCode	Real-Time Workshop system code	{'Auto'}   'Inline'   'Function'   'Reusable function'
RTWFcnNameOpts	Real-Time Workshop function name options	{'Auto'}   'Use subsystem name'   'User specified'
RTWFcnName	Real-Time Workshop function name	string {''}
RTWFileNameOpts	Real-Time Workshop filename options	{'Auto'}   'Use subsystem name'   'Use function name'   'User specified'
RTWFileName	Real-Time Workshop filename (no extension)	string {''}
DataTypeOverride	Specifies data type used to override fixed-point data types. Set by the <b>Data type override</b> control on the Fixed-Point Tool.	{'UseLocalSettings'}   'ScaledDoubles'   'TrueDoubles'   'TrueSingles'   'ForceOff'

**Ports & Subsystems Library Block Parameters (Continued)**

<b>Block (Type)/Parameter</b>	<b>Dialog Box Prompt</b>	<b>Values</b>
MinMaxOverflowLogging	Setting for fixed-point logging. Set by the <b>Logging mode</b> option in the Fixed-Point Tool.	{ 'UseLocalSettings'   'MinMaxAndOverflow'   'OverflowOnly'   'ForceOff' }
Code Reuse Subsystem (SubSystem)		
ShowPortLabels	Show port labels. The values 'on' and 'off' are for backward compatibility only and should not be used in new models or when updating existing models.	{ 'FromPortIcon'   'FromPortBlockName'   'Signal Name'   'none'   'on'   'off' }
BlockChoice	Block choice	{ '' }
TemplateBlock	Template block	string { '' }
MemberBlocks	Member blocks	string { '' }
Permissions	Read/Write permissions	{ 'ReadWrite'   'ReadOnly'   'NoReadOrWrite' }
ErrorFcn	Name of error callback function	string { '' }
PermitHierarchical Resolution	Permit hierarchical resolution	{ 'All'   'ParametersOnly'   'None' }
TreatAsAtomicUnit	Treat as atomic unit	{ 'on'   'off' }
MinAlgLoopOccurrences	Minimize algebraic loop occurrences	'on'   { 'off' }
PropExecContext OutsideSubsystem	Propagate execution context across subsystem boundary	{ 'on'   'off' }
CheckFcnCallInp InsideContextMsg	Warn if function-call inputs are context-specific	'on'   { 'off' }
SystemSampleTime	Sample time (-1 for inherited)	string { '-1' }

## Ports &amp; Subsystems Library Block Parameters (Continued)

Block (Type)/Parameter	Dialog Box Prompt	Values
RTWSystemCode	Real-Time Workshop system code	'Auto'   'Inline'   'Function'   {'Reusable function'}
RTWFcnNameOpts	Real-Time Workshop function name options	'Auto'   {'Use subsystem name'}   'User specified'
RTWFcnName	Real-Time Workshop function name	string {''}
RTWFileNameOpts	Real-Time Workshop filename options	'Auto'   'Use subsystem name'   {'Use function name'}   'User specified'
RTWFileName	Real-Time Workshop filename (no extension)	string {''}
DataTypeOverride	Specifies data type used to override fixed-point data types. Set by the <b>Data type override</b> control on the Fixed-Point Tool.	{'UseLocalSettings'}   'ScaledDoubles'   'TrueDoubles'   'TrueSingles'   'ForceOff'
MinMaxOverflowLogging	Setting for fixed-point logging. Set by the <b>Logging mode</b> option in the Fixed-Point Tool.	{'UseLocalSettings'}   'MinMaxAndOverflow'   'OverflowOnly'   'ForceOff'
Configurable Subsystem (SubSystem)		
ShowPortLabels	Show port labels. The values 'on' and 'off' are for backward compatibility only and should not be used in new models or when updating existing models.	{'FromPortIcon'}   'FromPortBlockName'   'Signal Name'   'none'   'on'   'off'
BlockChoice	Block choice	{''}
TemplateBlock	Template block	string {'self'}
MemberBlocks	Member blocks	string {''}

**Ports & Subsystems Library Block Parameters (Continued)**

<b>Block (Type)/Parameter</b>	<b>Dialog Box Prompt</b>	<b>Values</b>
Permissions	Read/Write permissions	{ 'ReadWrite'   'ReadOnly'   'NoReadOrWrite' }
ErrorFcn	Name of error callback function	string { '' }
PermitHierarchicalResolution	Permit hierarchical resolution	{ 'All'   'ParametersOnly'   'None' }
TreatAsAtomicUnit	Treat as atomic unit	'on'   {'off'}
MinAlgLoopOccurrences	Minimize algebraic loop occurrences	'on'   {'off'}
PropExecContextOutsideSubsystem	Propagate execution context across subsystem boundary	{ 'on' }   'off'
CheckFcnCallInpInsideContextMsg	Warn if function-call inputs are context-specific	'on'   {'off'}
SystemSampleTime	Sample time (-1 for inherited)	string { '-1' }
RTWSystemCode	Real-Time Workshop system code	{ 'Auto' }   'Inline'   'Function'   'Reusable function'
RTWFcnNameOpts	Real-Time Workshop function name options	{ 'Auto' }   'Use subsystem name'   'User specified'
RTWFcnName	Real-Time Workshop function name	string { '' }
RTWFileNameOpts	Real-Time Workshop filename options	{ 'Auto' }   'Use subsystem name'   'Use function name'   'User specified'
RTWFileName	Real-Time Workshop filename (no extension)	string { '' }

## Ports &amp; Subsystems Library Block Parameters (Continued)

Block (Type)/Parameter	Dialog Box Prompt	Values
DataTypeOverride	Specifies data type used to override fixed-point data types. Set by the <b>Data type override</b> control on the Fixed-Point Tool.	{ 'UseLocalSettings'   'ScaledDoubles'   'TrueDoubles'   'TrueSingles'   'ForceOff' }
MinMaxOverflowLogging	Setting for fixed-point logging. Set by the <b>Logging mode</b> option in the Fixed-Point Tool.	{ 'UseLocalSettings'   'MinMaxAndOverflow'   'OverflowOnly'   'ForceOff' }
Enable (EnablePort)		
StatesWhenEnabling	States when enabling	{ 'held' }   'reset'
ShowOutputPort	Show output port	'on'   { 'off' }
ZeroCross	Enable zero crossing detection	{ 'on' }   'off'
Enabled and Triggered Subsystem (SubSystem)		
ShowPortLabels	Show port labels. The values 'on' and 'off' are for backward compatibility only and should not be used in new models or when updating existing models.	{ 'FromPortIcon'   'FromPortBlockName'   'Signal Name'   'none'   'on'   'off' }
BlockChoice	Block choice	{ '' }
TemplateBlock	Template block	string { '' }
MemberBlocks	Member blocks	string { '' }
Permissions	Read/Write permissions	{ 'ReadWrite'   'ReadOnly'   'NoReadOrWrite' }
ErrorFcn	Name of error callback function	string { '' }

**Ports & Subsystems Library Block Parameters (Continued)**

<b>Block (Type)/Parameter</b>	<b>Dialog Box Prompt</b>	<b>Values</b>
PermitHierarchicalResolution	Permit hierarchical resolution	{ 'All' }   'ParametersOnly'   'None'
TreatAsAtomicUnit	Treat as atomic unit	{ 'on' }   'off'
MinAlgLoopOccurrences	Minimize algebraic loop occurrences	'on'   { 'off' }
PropExecContextOutsideSubsystem	Propagate execution context across subsystem boundary	{ 'on' }   'off'
CheckFcnCallInpInsideContextMsg	Warn if function-call inputs are context-specific	'on'   { 'off' }
SystemSampleTime	Sample time (-1 for inherited)	string { '-1' }
RTWSystemCode	Real-Time Workshop system code	{ 'Auto' }   'Inline'   'Function'   'Reusable function'
RTWFcnNameOpts	Real-Time Workshop function name options	{ 'Auto' }   'Use subsystem name'   'User specified'
RTWFcnName	Real-Time Workshop function name	string { '' }
RTWFileNameOpts	Real-Time Workshop filename options	{ 'Auto' }   'Use subsystem name'   'Use function name'   'User specified'
RTWFileName	Real-Time Workshop filename (no extension)	string { '' }
DataTypeOverride	Specifies data type used to override fixed-point data types. Set by the <b>Data type override</b> control on the Fixed-Point Tool.	{ 'UseLocalSettings' }   'ScaledDoubles'   'TrueDoubles'   'TrueSingles'   'ForceOff'

## Ports &amp; Subsystems Library Block Parameters (Continued)

Block (Type)/Parameter	Dialog Box Prompt	Values
MinMaxOverflowLogging	Setting for fixed-point logging. Set by the <b>Logging mode</b> option in the Fixed-Point Tool.	{ 'UseLocalSettings'   'MinMaxAndOverflow'   'OverflowOnly'   'ForceOff' }
EnabledSubsystem (SubSystem)		
ShowPortLabels	Show port labels. The values 'on' and 'off' are for backward compatibility only and should not be used in new models or when updating existing models.	{ 'FromPortIcon'   'FromPortBlockName'   'Signal Name'   'none'   'on'   'off' }
BlockChoice	Block choice	{ '' }
TemplateBlock	Template block	string { '' }
MemberBlocks	Member blocks	string { '' }
Permissions	Read/Write permissions	{ 'ReadWrite'   'ReadOnly'   'NoReadOrWrite' }
ErrorFcn	Name of error callback function	string { '' }
PermitHierarchicalResolution	Permit hierarchical resolution	{ 'All'   'ParametersOnly'   'None' }
TreatAsAtomicUnit	Treat as atomic unit	{ 'on'   'off' }
MinAlgLoopOccurrences	Minimize algebraic loop occurrences	'on'   { 'off' }
PropExecContextOutsideSubsystem	Propagate execution context across subsystem boundary	{ 'on'   'off' }
CheckFcnCallInpInsideContextMsg	Warn if function-call inputs are context-specific	'on'   { 'off' }
SystemSampleTime	Sample time (-1 for inherited)	string { '-1' }



## Ports &amp; Subsystems Library Block Parameters (Continued)

Block (Type)/Parameter	Dialog Box Prompt	Values
RTWSystemCode	Real-Time Workshop system code	{'Auto'}   'Inline'   'Function'   'Reusable function'
RTWFcnNameOpts	Real-Time Workshop function name options	{'Auto'}   'Use subsystem name'   'User specified'
RTWFcnName	Real-Time Workshop function name	string {' '}
RTWFileNameOpts	Real-Time Workshop filename options	{'Auto'}   'Use subsystem name'   'Use function name'   'User specified'
RTWFileName	Real-Time Workshop filename (no extension)	string {' '}
DataTypeOverride	Specifies data type used to override fixed-point data types. Set by the <b>Data type override</b> control on the Fixed-Point Tool.	{'UseLocalSettings'}   'ScaledDoubles'   'TrueDoubles'   'TrueSingles'   'ForceOff'
MinMaxOverflowLogging	Setting for fixed-point logging. Set by the <b>Logging mode</b> option in the Fixed-Point Tool.	{'UseLocalSettings'}   'MinMaxAndOverflow'   'OverflowOnly'   'ForceOff'
For Iterator (ForIterator)		
ResetStates	States when starting	{'held'}   'reset'
IterationSource	Iteration limit source	{'internal'}   'external'
IterationLimit	Iteration limit	string {'5'}
ExternalIncrement	Set next i (iteration variable) externally	'on'   {'off'}
ShowIterationPort	Show iteration variable	{'on'}   'off'
IndexMode	Index mode	'Zero-based'   {'One-based'}

**Ports & Subsystems Library Block Parameters (Continued)**

<b>Block (Type)/Parameter</b>	<b>Dialog Box Prompt</b>	<b>Values</b>
IterationVariable DataType	Iteration variable data type	{'int32'}   'int16'   'int8'   'double'
For Iterator Subsystem (SubSystem)		
ShowPortLabels	Show port labels. The values 'on' and 'off' are for backward compatibility only and should not be used in new models or when updating existing models.	{'FromPortIcon'}   'FromPortBlockName'   'Signal Name'   'none'   'on'   'off'
BlockChoice	Block choice	{''}
TemplateBlock	Template block	string {''}
MemberBlocks	Member blocks	string {''}
Permissions	Read/Write permissions	{'ReadWrite'}   'ReadOnly'   'NoReadOrWrite'
ErrorFcn	Name of error callback function	string {''}
PermitHierarchical Resolution	Permit hierarchical resolution	{'All'}   'ParametersOnly'   'None'
TreatAsAtomicUnit	Treat as atomic unit	{'on'}   'off'
MinAlgLoopOccurrences	Minimize algebraic loop occurrences	'on'   {'off'}
PropExecContext OutsideSubsystem	Propagate execution context across subsystem boundary	{'on'}   'off'
CheckFcnCallInp InsideContextMsg	Warn if function-call inputs are context-specific	'on'   {'off'}
SystemSampleTime	Sample time (-1 for inherited)	string{'-1'}

## Ports &amp; Subsystems Library Block Parameters (Continued)

Block (Type)/Parameter	Dialog Box Prompt	Values
RTWSystemCode	Real-Time Workshop system code	{'Auto'}   'Inline'   'Function'   'Reusable function'
RTWFcnNameOpts	Real-Time Workshop function name options	{'Auto'}   'Use subsystem name'   'User specified'
RTWFcnName	Real-Time Workshop function name	string {''}
RTWFileNameOpts	Real-Time Workshop filename options	{'Auto'}   'Use subsystem name'   'Use function name'   'User specified'
RTWFileName	Real-Time Workshop filename (no extension)	string {''}
DataTypeOverride	Specifies data type used to override fixed-point data types. Set by the <b>Data type override</b> control on the Fixed-Point Tool.	{'UseLocalSettings'}   'ScaledDoubles'   'TrueDoubles'   'TrueSingles'   'ForceOff'
MinMaxOverflowLogging	Setting for fixed-point logging. Set by the <b>Logging mode</b> option in the Fixed-Point Tool.	{'UseLocalSettings'}   'MinMaxAndOverflow'   'OverflowOnly'   'ForceOff'
Function-Call Generator (Function-Call Generator) (masked subsystem)		
sample_time	Sample time	string {'1'}
numberOfIterations	Number of iterations	string {'1'}
Function-Call Subsystem (SubSystem)		
ShowPortLabels	Show port labels. The values 'on' and 'off' are for backward compatibility only and should not be used in new models or when updating existing models.	{'FromPortIcon'}   'FromPortBlockName'   'Signal Name'   'none'   'on'   'off'

**Ports & Subsystems Library Block Parameters (Continued)**

<b>Block (Type)/Parameter</b>	<b>Dialog Box Prompt</b>	<b>Values</b>
BlockChoice	Block choice	{ '' }
TemplateBlock	Template block	string { '' }
MemberBlocks	Member blocks	string { '' }
Permissions	Read/Write permissions	{ 'ReadWrite'   'ReadOnly'   'NoReadOrWrite' }
ErrorFcn	Name of error callback function	string { '' }
PermitHierarchicalResolution	Permit hierarchical resolution	{ 'All'   'ParametersOnly'   'None' }
TreatAsAtomicUnit	Treat as atomic unit	{ 'on'   'off' }
MinAlgLoopOccurrences	Minimize algebraic loop occurrences	'on'   { 'off' }
PropExecContextOutsideSubsystem	Propagate execution context across subsystem boundary	{ 'on'   'off' }
CheckFcnCallInpInsideContextMsg	Warn if function-call inputs are context-specific	'on'   { 'off' }
SystemSampleTime	Sample time (-1 for inherited)	string { '-1' }
RTWSystemCode	Real-Time Workshop system code	{ 'Auto'   'Inline'   'Function'   'Reusable function' }
RTWFcnNameOpts	Real-Time Workshop function name options	{ 'Auto'   'Use subsystem name'   'User specified' }
RTWFcnName	Real-Time Workshop function name	string { '' }
RTWFileNameOpts	Real-Time Workshop filename options	{ 'Auto'   'Use subsystem name'   'Use function name'   'User specified' }

## Ports &amp; Subsystems Library Block Parameters (Continued)

Block (Type)/Parameter	Dialog Box Prompt	Values
RTWFileName	Real-Time Workshop filename (no extension)	string {''}
DataTypeOverride	Specifies data type used to override fixed-point data types. Set by the <b>Data type override</b> control on the Fixed-Point Tool.	{'UseLocalSettings'   'ScaledDoubles'   'TrueDoubles'   'TrueSingles'   'ForceOff'}
MinMaxOverflowLogging	Setting for fixed-point logging. Set by the <b>Logging mode</b> option in the Fixed-Point Tool.	{'UseLocalSettings'   'MinMaxAndOverflow'   'OverflowOnly'   'ForceOff'}
If (If)		
NumInputs	Number of inputs	string {'1'}
IfExpression	If expression (e.g., u1 ~= 0)	string {'u1 > 0'}
ElseIfExpressions	Elseif expressions (comma-separated list, e.g., u2 ~= 0, u3(2) < u2)	string {''}
ShowElse	Show else condition	{'on'}   'off'
ZeroCross	Enable zero crossing detection	{'on'}   'off'
SampleTime	Sample time (-1 for inherited)	string {'-1'}
If Action Subsystem (SubSystem)		
ShowPortLabels	Show port labels. The values 'on' and 'off' are for backward compatibility only and should not be used in new models or when updating existing models.	{'FromPortIcon'   'FromPortBlockName'   'Signal Name'   'none'   'on'   'off'}
BlockChoice	Block choice	{''}
TemplateBlock	Template block	string {''}

**Ports & Subsystems Library Block Parameters (Continued)**

<b>Block (Type)/Parameter</b>	<b>Dialog Box Prompt</b>	<b>Values</b>
MemberBlocks	Member blocks	string {''}
Permissions	Read/Write permissions	{'ReadWrite'   'ReadOnly'   'NoReadOrWrite'}
ErrorFcn	Name of error callback function	string {''}
PermitHierarchicalResolution	Permit hierarchical resolution	{'All'   'ParametersOnly'   'None'}
TreatAsAtomicUnit	Treat as atomic unit	{'on'   'off'}
MinAlgLoopOccurrences	Minimize algebraic loop occurrences	'on'   {'off'}
PropExecContextOutsideSubsystem	Propagate execution context across subsystem boundary	{'on'   'off'}
CheckFcnCallInpInsideContextMsg	Warn if function-call inputs are context-specific	'on'   {'off'}
SystemSampleTime	Sample time (-1 for inherited)	string {'-1'}
RTWSystemCode	Real-Time Workshop system code	{'Auto'   'Inline'   'Function'   'Reusable function'}
RTWFcnNameOpts	Real-Time Workshop function name options	{'Auto'   'Use subsystem name'   'User specified'}
RTWFcnName	Real-Time Workshop function name	string {''}
RTWFileNameOpts	Real-Time Workshop filename options	{'Auto'   'Use subsystem name'   'Use function name'   'User specified'}
RTWFileName	Real-Time Workshop filename (no extension)	string {''}

## Ports &amp; Subsystems Library Block Parameters (Continued)

Block (Type)/Parameter	Dialog Box Prompt	Values
DataTypeOverride	Specifies data type used to override fixed-point data types. Set by the <b>Data type override</b> control on the Fixed-Point Tool.	{ 'UseLocalSettings'   'ScaledDoubles'   'TrueDoubles'   'TrueSingles'   'ForceOff' }
MinMaxOverflowLogging	Setting for fixed-point logging. Set by the <b>Logging mode</b> option in the Fixed-Point Tool.	{ 'UseLocalSettings'   'MinMaxAndOverflow'   'OverflowOnly'   'ForceOff' }
In1 (Inport)		
Port	Port number	string {'1'}
IconDisplay	Icon display	'Signal name'   {'Port number'}   'Port number and signal name'
UseBusObject	Specify properties via bus object	'on'   {'off'}
BusObject	Bus object for validating input bus	string {'BusObject'}
BusOutputAsStruct	Output as nonvirtual bus	'on'   {'off'}
PortDimensions	Port dimensions (-1 for inherited)	string {'-1'}
SampleTime	Sample time (-1 for inherited)	string {'-1'}
OutMin	Minimum	string {'[]'}
OutMax	Maximum	string {'[]'}
OutDataTypeStr	Data type	string {'Inherit: auto'   'double'   'single'   'int8'   'uint8'   'int16'   'uint16'   'int32'   'uint32'   'boolean' }

**Ports & Subsystems Library Block Parameters (Continued)**

<b>Block (Type)/Parameter</b>	<b>Dialog Box Prompt</b>	<b>Values</b>
SignalType	Signal type	{'auto'}   'real'   'complex'
SamplingMode	Sampling mode	{'auto'}   'Sample based'   'Frame based'
LatchByDelaying OutsideSignal	Latch input by delaying outside signal	'on'   {'off'}
LatchByCopying InsideSignal	Latch input by copying inside signal	'on'   {'off'}
Interpolate	Interpolate data	{'on'}   'off'
<b>Model (ModelReference)</b>		
ModelName	Model name (without the .mdl extension)	string {'<Enter Model Name>'}
ParameterArgumentNames	Model arguments	string {''}
ParameterArgumentValues	Model argument values (for this instance)	string {''}
SimulationMode	Whether to simulate the model by generating and executing code or by interpreting the model in Simulink	{'Accelerator'}   'Normal'
AvailSigsInstanceProps		handle vector {''}
AvailSigsDefaultProps		handle vector {''}
UpdateSigLoggingInfo	For internal use	
DefaultDataLogging		'on'   {'off'}
<b>Out1 (Output)</b>		
Port	Port number	string {'1'}
IconDisplay	Icon display	'Signal name'   {'Port number'}   'Port number and signal name'



**Ports & Subsystems Library Block Parameters (Continued)**

<b>Block (Type)/Parameter</b>	<b>Dialog Box Prompt</b>	<b>Values</b>
UseBusObject	Specify properties via bus object	'on'   {'off'}
BusObject	Bus object for validating input bus	string {'BusObject'}
BusOutputAsStruct	Output as nonvirtual bus in parent model	'on'   {'off'}
PortDimensions	Port dimensions (-1 for inherited)	string {'-1'}
SampleTime	Sample time (-1 for inherited)	string {'-1'}
OutMin	Minimum	string {'[]'}
OutMax	Maximum	string {'[]'}
OutDataTypeStr	Data type	string {'Inherit: auto'   'double'   'single'   'int8'   'uint8'   'int16'   'uint16'   'int32'   'uint32'   'boolean'}
SignalType	Signal type	{'auto'}   'real'   'complex'
SamplingMode	Sampling mode	{'auto'}   'Sample based'   'Frame based'
OutputWhenDisabled	Output when disabled	{'held'}   'reset'
InitialOutput	Initial output	string {'[]'}
<b>Subsystem (SubSystem)</b>		
ShowPortLabels	Show port labels. The values 'on' and 'off' are for backward compatibility only and should not be used in new models or when updating existing models.	{'FromPortIcon'   'FromPortBlockName'   'Signal Name'   'none'   'on'   'off'}

**Ports & Subsystems Library Block Parameters (Continued)**

<b>Block (Type)/Parameter</b>	<b>Dialog Box Prompt</b>	<b>Values</b>
BlockChoice	Block choice	{ '' }
TemplateBlock	Template block	string { '' }
MemberBlocks	Member blocks	string { '' }
Permissions	Read/Write permissions	{ 'ReadWrite'   'ReadOnly'   'NoReadOrWrite' }
ErrorFcn	Name of error callback function	string { '' }
PermitHierarchicalResolution	Permit hierarchical resolution	{ 'All'   'ParametersOnly'   'None' }
TreatAsAtomicUnit	Treat as atomic unit	'on'   { 'off' }
MinAlgLoopOccurrences	Minimize algebraic loop occurrences	'on'   { 'off' }
PropExecContextOutsideSubsystem	Propagate execution context across subsystem boundary	{ 'on' }   'off'
CheckFcnCallInpInsideContextMsg	Warn if function-call inputs are context-specific	'on'   { 'off' }
SystemSampleTime	Sample time (-1 for inherited)	string { '-1' }
RTWSystemCode	Real-Time Workshop system code	{ 'Auto'   'Inline'   'Function'   'Reusable function' }
RTWFcnNameOpts	Real-Time Workshop function name options	{ 'Auto'   'Use subsystem name'   'User specified' }
RTWFcnName	Real-Time Workshop function name	string { '' }
RTWFileNameOpts	Real-Time Workshop filename options	{ 'Auto'   'Use subsystem name'   'Use function name'   'User specified' }

**Ports & Subsystems Library Block Parameters (Continued)**

<b>Block (Type)/Parameter</b>	<b>Dialog Box Prompt</b>	<b>Values</b>
RTWFileName	Real-Time Workshop filename (no extension)	string {''}
DataTypeOverride	Specifies data type used to override fixed-point data types. Set by the <b>Data type override</b> control on the Fixed-Point Tool.	{'UseLocalSettings'   'ScaledDoubles'   'TrueDoubles'   'TrueSingles'   'ForceOff'}
MinMaxOverflowLogging	Setting for fixed-point logging. Set by the <b>Logging mode</b> option in the Fixed-Point Tool.	{'UseLocalSettings'   'MinMaxAndOverflow'   'OverflowOnly'   'ForceOff'}
Virtual	For internal use	
Switch Case (SwitchCase)		
CaseConditions	Case conditions (e.g., {1,[2,3]})	string {'{1}'}
CaseShowDefault	Show default case	{'on'}   'off'
ZeroCross	Enable zero-crossing detection	{'on'}   'off'
SampleTime	Sample time (-1 for inherited)	string {'-1'}
Switch Case Action Subsystem (SubSystem)		
ShowPortLabels	Show port labels. The values 'on' and 'off' are for backward compatibility only and should not be used in new models or when updating existing models.	{'FromPortIcon'   'FromPortBlockName'   'Signal Name'   'none'   'on'   'off'}
BlockChoice	Block choice	{''}
TemplateBlock	Template block	string {''}
MemberBlocks	Member blocks	string {''}

**Ports & Subsystems Library Block Parameters (Continued)**

<b>Block (Type)/Parameter</b>	<b>Dialog Box Prompt</b>	<b>Values</b>
Permissions	Read/Write permissions	{ 'ReadWrite'   'ReadOnly'   'NoReadOrWrite' }
ErrorFcn	Name of error callback function	string { '' }
PermitHierarchicalResolution	Permit hierarchical resolution	{ 'All'   'ParametersOnly'   'None' }
TreatAsAtomicUnit	Treat as atomic unit	{ 'on'   'off' }
MinAlgLoopOccurrences	Minimize algebraic loop occurrences	'on'   { 'off' }
PropExecContextOutsideSubsystem	Propagate execution context across subsystem boundary	{ 'on'   'off' }
CheckFcnCallInpInsideContextMsg	Warn if function-call inputs are context-specific	'on'   { 'off' }
SystemSampleTime	Sample time (-1 for inherited)	string { '-1' }
RTWSystemCode	Real-Time Workshop system code	{ 'Auto'   'Inline'   'Function'   'Reusable function' }
RTWFcnNameOpts	Real-Time Workshop function name options	{ 'Auto'   'Use subsystem name'   'User specified' }
RTWFcnName	Real-Time Workshop function name	string { '' }
RTWFileNameOpts	Real-Time Workshop filename options	{ 'Auto'   'Use subsystem name'   'Use function name'   'User specified' }
RTWFileName	Real-Time Workshop filename (no extension)	string { '' }

**Ports & Subsystems Library Block Parameters (Continued)**

<b>Block (Type)/Parameter</b>	<b>Dialog Box Prompt</b>	<b>Values</b>
DataTypeOverride	Specifies data type used to override fixed-point data types. Set by the <b>Data type override</b> control on the Fixed-Point Tool.	{ 'UseLocalSettings'   'ScaledDoubles'   'TrueDoubles'   'TrueSingles'   'ForceOff' }
MinMaxOverflowLogging	Setting for fixed-point logging. Set by the <b>Logging mode</b> option in the Fixed-Point Tool.	{ 'UseLocalSettings'   'MinMaxAndOverflow'   'OverflowOnly'   'ForceOff' }
<b>Trigger (TriggerPort)</b>		
TriggerType	Trigger type	{ 'rising'   'falling'   'either'   'function-call' }
StatesWhenEnabling	States when enabling	{ 'held'   'reset'   'inherit' }
ShowOutputPort	Show output port	'on'   {'off'}
OutputDataType	Output data type	{ 'auto'   'double'   'int8' }
SampleTimeType	Sample time type	{ 'triggered'   'periodic' }
SampleTime	Sample time	string {'1'}
ZeroCross	Enable zero crossing detection	{ 'on'   'off' }
<b>Triggered Subsystem (SubSystem)</b>		
ShowPortLabels	Show port labels. The values 'on' and 'off' are for backward compatibility only and should not be used in new models or when updating existing models.	{ 'FromPortIcon'   'FromPortBlockName'   'Signal Name'   'none'   'on'   'off' }
BlockChoice	Block choice	{ '' }

**Ports & Subsystems Library Block Parameters (Continued)**

<b>Block (Type)/Parameter</b>	<b>Dialog Box Prompt</b>	<b>Values</b>
TemplateBlock	Template block	string {''}
MemberBlocks	Member blocks	string {''}
Permissions	Read/Write permissions	{'ReadWrite'   'ReadOnly'   'NoReadOrWrite'}
ErrorFcn	Name of error callback function	string {''}
PermitHierarchical Resolution	Permit hierarchical resolution	{'All'}   'ParametersOnly'   'None'
TreatAsAtomicUnit	Treat as atomic unit	{'on'}   'off'
MinAlgLoopOccurrences	Minimize algebraic loop occurrences	'on'   {'off'}
PropExecContext OutsideSubsystem	Propagate execution context across subsystem boundary	{'on'}   'off'
CheckFcnCallInp InsideContextMsg	Warn if function-call inputs are context-specific	'on'   {'off'}
SystemSampleTime	Sample time (-1 for inherited)	string {'-1'}
RTWSystemCode	Real-Time Workshop system code	{'Auto'}   'Inline'   'Function'   'Reusable function'
RTWFcnNameOpts	Real-Time Workshop function name options	{'Auto'}   'Use subsystem name'   'User specified'
RTWFcnName	Real-Time Workshop function name	string {''}
RTWFileNameOpts	Real-Time Workshop filename options	{'Auto'}   'Use subsystem name'   'Use function name'   'User specified'
RTWFileName	Real-Time Workshop filename (no extension)	string {''}

## Ports &amp; Subsystems Library Block Parameters (Continued)

Block (Type)/Parameter	Dialog Box Prompt	Values
DataTypeOverride	Specifies data type used to override fixed-point data types. Set by the <b>Data type override</b> control on the Fixed-Point Tool.	{ 'UseLocalSettings'   'ScaledDoubles'   'TrueDoubles'   'TrueSingles'   'ForceOff' }
MinMaxOverflowLogging	Setting for fixed-point logging. Set by the <b>Logging mode</b> option in the Fixed-Point Tool.	{ 'UseLocalSettings'   'MinMaxAndOverflow'   'OverflowOnly'   'ForceOff' }
While Iterator (WhileIterator)		
MaxIters	Maximum number of iterations (-1 for unlimited)	string {'5'}
WhileBlockType	While loop type	{ 'while' }   'do-while'
ResetStates	States when starting	{ 'held' }   'reset'
ShowIterationPort	Show iteration number port	'on'   {'off'}
OutputDataType	Output data type	{ 'int32' }   'int16'   'int8'   'double'
While Iterator Subsystem (SubSystem)		
ShowPortLabels	Show port labels. The values 'on' and 'off' are for backward compatibility only and should not be used in new models or when updating existing models.	{ 'FromPortIcon'   'FromPortBlockName'   'Signal Name'   'none'   'on'   'off' }
BlockChoice	Block choice	{ '' }
TemplateBlock	Template block	string { '' }
MemberBlocks	Member blocks	string { '' }
Permissions	Read/Write permissions	{ 'ReadWrite'   'ReadOnly'   'NoReadOrWrite' }

**Ports & Subsystems Library Block Parameters (Continued)**

<b>Block (Type)/Parameter</b>	<b>Dialog Box Prompt</b>	<b>Values</b>
ErrorFcn	Name of error callback function	string {''}
PermitHierarchicalResolution	Permit hierarchical resolution	{'All'}   'ParametersOnly'   'None'
TreatAsAtomicUnit	Treat as atomic unit	{'on'}   'off'
MinAlgLoopOccurrences	Minimize algebraic loop occurrences	'on'   {'off'}
PropExecContextOutsideSubsystem	Propagate execution context across subsystem boundary	{'on'}   'off'
CheckFcnCallInpInsideContextMsg	Warn if function-call inputs are context-specific	'on'   {'off'}
SystemSampleTime	Sample time (-1 for inherited)	string {'-1'}
RTWSystemCode	Real-Time Workshop system code	{'Auto'}   'Inline'   'Function'   'Reusable function'
RTWFcnNameOpts	Real-Time Workshop function name options	{'Auto'}   'Use subsystem name'   'User specified'
RTWFcnName	Real-Time Workshop function name	string {''}
RTWFileNameOpts	Real-Time Workshop filename options	{'Auto'}   'Use subsystem name'   'Use function name'   'User specified'
RTWFileName	Real-Time Workshop filename (no extension)	string {''}



**Ports & Subsystems Library Block Parameters (Continued)**

<b>Block (Type)/Parameter</b>	<b>Dialog Box Prompt</b>	<b>Values</b>
DataTypeOverride	Specifies data type used to override fixed-point data types. Set by the <b>Data type override</b> control on the Fixed-Point Tool.	{ 'UseLocalSettings'   'ScaledDoubles'   'TrueDoubles'   'TrueSingles'   'ForceOff' }
MinMaxOverflowLogging	Setting for fixed-point logging. Set by the <b>Logging mode</b> option in the Fixed-Point Tool.	{ 'UseLocalSettings'   'MinMaxAndOverflow'   'OverflowOnly'   'ForceOff' }

**Signal Attributes Library Block Parameters**

<b>Block (Type)/Parameter</b>	<b>Dialog Box Prompt</b>	<b>Values</b>
Data Type Conversion (DataTypeConversion)		
OutMin	Output minimum	string {'[]'}
OutMax	Output maximum	string {'[]'}
OutDataTypeStr	Output data type	string {'Inherit: Inherit via back propagation'   'double'   'single'   'int8'   'uint8'   'int16'   'uint16'   'int32'   'uint32'   'boolean' }
LockScale	Lock output scaling against changes by the autoscaling tool	'on'   {'off'}
ConvertRealWorld	Input and output to have equal	{ 'Real World Value (RWV)'   'Stored Integer (SI)' }
RndMeth	Round integer calculations toward	'Zero'   'Nearest'   'Ceiling'   {'Floor'}   'Simplest'

**Signal Attributes Library Block Parameters (Continued)**

<b>Block (Type)/Parameter</b>	<b>Dialog Box Prompt</b>	<b>Values</b>
SaturateOnInteger Overflow	Saturate on integer overflow	'on'   {'off'}
SampleTime	Sample time (-1 for inherited)	string {'-1'}
Data Type Conversion Inherited (Conversion Inherited) (masked subsystem)		
ConvertRealWorld	Input and Output to have equal	{'Real World Value'}   'Stored Integer'
RndMeth	Round toward	'Zero'   'Nearest'   'Ceiling'   {'Floor'}
DoSatur	Saturate to max or min when overflows occur	'on'   {'off'}
Data Type Duplicate (Data Type Duplicate) (masked subsystem)		
NumInputPorts	Number of input ports	string {'2'}
Data Type Propagation (Data Type Propagation) (masked subsystem)		
PropDataTypeMode	1. Propagated data type	'Specify via dialog'   {'Inherit via propagation rule'}
PropDataType	1.1. Propagated data type: ex. sfix(16), uint(8), float('single')	string {'sfix(16)'}
IfRefDouble	1.1. If any reference input is double, output is	{'double'}   'single'
IfRefSingle	1.2. If any reference input is single, output is	'double'   {'single'}
IsSigned	1.3. Is-Signed	'IsSigned1'   'IsSigned2'   {'IsSigned1 or IsSigned2'}   'TRUE'   'FALSE'

**Signal Attributes Library Block Parameters (Continued)**

<b>Block (Type)/Parameter</b>	<b>Dialog Box Prompt</b>	<b>Values</b>
NumBitsBase	1.4.1. Number-of-Bits: Base	'NumBits1'   'NumBits2'   {'max([NumBits1 NumBits2])}'   'min([NumBits1 NumBits2])'   'NumBits1+NumBits2'
NumBitsMult	1.4.2. Number-of-Bits: Multiplicative adjustment	string {'1'}
NumBitsAdd	1.4.3. Number-of-Bits: Additive adjustment	string {'0'}
NumBitsAllowFinal	1.4.4. Number-of-Bits: Allowable final values	string {'1:128'}
PropScalingMode	2. Propagated scaling	'Specify via dialog'   {'Inherit via propagation rule'}   'Obtain via best precision'
PropScaling	2.1. Propagated scaling: Slope or [Slope Bias] ex. 2 <sup>-9</sup>	string {'2 <sup>-10</sup> '}
ValuesUsedBestPrec	2.1. Values used to determine best precision scaling	string {'[5 -7]'}
SlopeBase	2.1.1. Slope: Base	'Slope1'   'Slope2'   'max([Slope1 Slope2])'   {'min([Slope1 Slope2])}'     'Slope1*Slope2'   'Slope1/Slope2'   'PosRange1'   'PosRange2'   'max([PosRange1 PosRange2])'   'min([PosRange1 PosRange2])'   'PosRange1*PosRange2'   'PosRange1/PosRange2'

**Signal Attributes Library Block Parameters (Continued)**

<b>Block (Type)/Parameter</b>	<b>Dialog Box Prompt</b>	<b>Values</b>
SlopeMult	2.1.2. Slope: Multiplicative adjustment	string {'1'}
SlopeAdd	2.1.3. Slope: Additive adjustment	string {'0'}
BiasBase	2.2.1. Bias: Base	{'Bias1'}   'Bias2'   'max([Bias1 Bias2])'   'min([Bias1 Bias2])'   'Bias1*Bias2'   'Bias1/Bias2'   'Bias1+Bias2'   'Bias1-Bias2'
BiasMult	2.2.2. Bias: Multiplicative adjustment	string {'1'}
BiasAdd	2.2.3. Bias: Additive adjustment	string {'0'}
Data Type Scaling Strip (Scaling Strip) (masked subsystem)		
IC (InitialCondition)		
Value	Initial value	string {'1'}
SampleTime	Sample time (-1 for inherited)	string {'-1'}
Probe (Probe)		
ProbeWidth	Probe width	{'on'}   'off'
ProbeSampleTime	Probe sample time	{'on'}   'off'
ProbeComplexSignal	Detect complex signal	{'on'}   'off'
ProbeSignalDimensions	Probe signal dimensions	{'on'}   'off'
ProbeFramedSignal	Detect framed signal	{'on'}   'off'

**Signal Attributes Library Block Parameters (Continued)**

<b>Block (Type)/Parameter</b>	<b>Dialog Box Prompt</b>	<b>Values</b>
ProbeWidthDataType	Data type for width	{'double'}   'single'   'int8'   'uint8'   'int16'   'uint16'   'int32'   'uint32'   'boolean'   'Same as input'
ProbeSampleTimeDataType	Data type for sample time	{'double'}   'single'   'int8'   'uint8'   'int16'   'uint16'   'int32'   'uint32'   'boolean'   'Same as input'
ProbeComplexityDataType	Data type for signal complexity	{'double'}   'single'   'int8'   'uint8'   'int16'   'uint16'   'int32'   'uint32'   'boolean'   'Same as input'
ProbeDimensionsDataType	Data type for signal dimensions	{'double'}   'single'   'int8'   'uint8'   'int16'   'uint16'   'int32'   'uint32'   'boolean'   'Same as input'
ProbeFrameDataType	Data type for signal frames	{'double'}   'single'   'int8'   'uint8'   'int16'   'uint16'   'int32'   'uint32'   'boolean'   'Same as input'
<b>Rate Transition (RateTransition)</b>		
Integrity	Ensure data integrity during data transfer	{'on'}   'off'

**Signal Attributes Library Block Parameters (Continued)**

<b>Block (Type)/Parameter</b>	<b>Dialog Box Prompt</b>	<b>Values</b>
Deterministic	Ensure deterministic data transfer (maximum delay)	{'on'}   'off'
X0	Initial conditions	string {'0'}
OutPortSampleTime	Output port sample time	string {'-1'}
Signal Conversion (SignalConversion)		
ConversionOutput	Output	{'Contiguous copy'}   'Bus copy'   'Virtual bus'   'Nonvirtual bus'
OverrideOpt	Override optimizations and always copy signal	'on'   {'off'}
Signal Specification (SignalSpecification)		
Dimensions	Dimensions (-1 for inherited)	string {'-1'}
SampleTime	Sample time (-1 for inherited)	string {'-1'}
OutMin	Minimum	string {'[]'}
OutMax	Maximum	string {'[]'}
OutDataTypeStr	Data type	string {'Inherit: auto'}   'double'   'single'   'int8'   'uint8'   'int16'   'uint16'   'int32'   'uint32'   'boolean'
SignalType	Signal type	{'auto'}   'real'   'complex'
SamplingMode	Sampling mode	{'auto'}   'Sample based'   'Frame based'
Weighted Sample Time (Sample Time Math) (masked subsystem)		
TsampMathOp	Operation	'+'   '-'   '*'   '/'   {'Ts Only'}   '1/Ts Only'
weightValue	Weight value	string {'1.0'}

**Signal Attributes Library Block Parameters (Continued)**

<b>Block (Type)/Parameter</b>	<b>Dialog Box Prompt</b>	<b>Values</b>
TsampMathImp	Implement using	{'Online Calculations'}   'Offline Scaling Adjustment'
OutputDataTypeScaling Mode	Output data type and scaling	{'Inherit via internal rule'}   'Inherit via back propagation'
RndMeth	Round toward	'Zero'   'Nearest'   'Ceiling'   {'Floor'}
DoSatur	Saturate to max or min when overflows occur	'on'   {'off'}
Width (Width)		
OutputDataTypeScaling Mode	Output data type mode	{'Choose intrinsic data type'}   'Inherit via back propagation'   'All ports same datatype'
DataType	Output data type	{'double'}   'single'   'int8'   'uint8'   'int16'   'uint16'   'int32'   'uint32'

**Signal Routing Library Block Parameters**

<b>Block (Type)/Parameter</b>	<b>Dialog Box Prompt</b>	<b>Values</b>
Bus Assignment (BusAssignment)		
AssignedSignals	Signals that are being assigned	string {''}
InputSignals	Signals in the bus	matrix {'{'}{'}'}
Bus Creator (BusCreator)		

## Signal Routing Library Block Parameters (Continued)

Block (Type)/Parameter	Dialog Box Prompt	Values
Inputs	Number of inputs. Can be an integer or a comma-separated list of signal names. For example, <code>set_param(gcb, 'a', 'b')</code> ; sets the currently selected Bus Creator block two have two inputs named a and b.	string {'2'}
DisplayOption		'none'   'signals'   {'bar'}
UseBusObject	Specify properties via bus object	'on'   {'off'}
BusObject	For internal use	
NonVirtualBus	Output as nonvirtual bus	'on'   {'off'}
Bus Selector (BusSelector)		
OutputSignals	Specifies the names of the input bus signals selected for output. Corresponds to the <b>Selected signals</b> list on the block's parameter dialog box.	string {'signal1,signal2'}
OutputAsBus	Output as bus	'on'   {'off'}
InputSignals	Specifies the names of the signal elements of the bus connected to the Bus Selector's input port.	matrix {'{'}{'}'}
Data Store Memory (DataStoreMemory)		
DataStoreName	Data store name	string {'A'}
ReadBeforeWriteMsg	Detect read before write	'none'   {'warning'}   'error'



**Signal Routing Library Block Parameters (Continued)**

<b>Block (Type)/Parameter</b>	<b>Dialog Box Prompt</b>	<b>Values</b>
WriteAfterWriteMsg	Detect write after write	'none'   {'warning'}   'error'
WriteAfterReadMsg	Detect write after read	'none'   {'warning'}   'error'
InitialValue	Initial value	string {'0'}
StateMustResolveToSignalObject	Data store name must resolve to Simulink signal object	'on'   {'off'}
RTWStateStorageClass	RTW storage class	{'Auto'}   'ExportedGlobal'   'ImportedExtern'   'ImportedExternPointer'
RTWStateStorageTypeQualifier	RTW type qualifier	string {' '}
VectorParams1D	Interpret vector parameters as 1-D	{'on'}   'off'
ShowAdditionalParam	Show additional parameters	'on'   {'off'}
OutMin	Minimum	string {'[]'}
OutMax	Maximum	string {'[]'}
OutDataTypeStr	Data type	string {'Inherit: auto'}   'double'   'single'   'int8'   'uint8'   'int16'   'uint16'   'int32'   'uint32'   'boolean'
SignalType	Signal type	{'auto'}   'real'   'complex'
<b>Data Store Read (DataStoreRead)</b>		
DataStoreName	Data store name	string {'A'}
SampleTime	Sample time	string {'0'}
<b>Data Store Write (DataStoreWrite)</b>		

**Signal Routing Library Block Parameters (Continued)**

<b>Block (Type)/Parameter</b>	<b>Dialog Box Prompt</b>	<b>Values</b>
DataStoreName	Data store name	string {'A'}
SampleTime	Sample time (-1 for inherited)	string {'-1'}
Demux (Demux)		
Outputs	Number of outputs	string {'2'}
DisplayOption	Display option	'none'   {'bar'}
BusSelectionMode	Bus selection mode	'on'   {'off'}
Environment Controller (Environment Controller) (masked subsystem)		
From (From)		
GotoTag	Goto tag	string {'A'}
IconDisplay	Icon display	'Signal name'   {'Tag'}   'Tag and signal name'
Goto (Goto)		
GotoTag	Tag	string {'A'}
IconDisplay	Icon display	'Signal name'   {'Tag'}   'Tag and signal name'
TagVisibility	Tag visibility	{'local'}   'scoped'   'global'
Goto Tag Visibility (GotoTagVisibility)		
GotoTag	Goto tag	string {'A'}
Index Vector (MultiPortSwitch)		
Inputs	Number of inputs	string {'1'}
zeroidx	Use zero-based indexing	{'on'}   'off'
InputSameDT	Require all data port inputs to have same data type	'on'   {'off'}

**Signal Routing Library Block Parameters (Continued)**

<b>Block (Type)/Parameter</b>	<b>Dialog Box Prompt</b>	<b>Values</b>
OutDataTypeMode	Output data type mode	{'Inherit via internal rule'}   'Inherit via back propagation'
RndMeth	Round integer calculations toward	'Zero'   'Nearest'   'Ceiling'   {'Floor'}
SaturateOnInteger Overflow	Saturate on integer overflow	'on'   {'off'}
SampleTime	Sample time (-1 for inherited)	string {'-1'}
<b>Manual Switch (Manual Switch) (masked subsystem)</b>		
sw	Current setting	string {'1'}
action	Action	string {'0'}
<b>Merge (Merge)</b>		
Inputs	Number of inputs	string {'2'}
InitialOutput	Initial output	string {'[]'}
AllowUnequalInput PortWidths	Allow unequal port widths	'on'   {'off'}
InputPortOffsets	Input port offsets	string {'[]'}
<b>Multiport Switch (MultiPortSwitch)</b>		
Inputs	Number of inputs	string {'3'}
zeroidx	Use zero-based indexing	'on'   {'off'}
InputSameDT	Require all data port inputs to have the same data type	'on'   {'off'}
OutMin	Output minimum	string {'[]'}
OutMax	Output maximum	string {'[]'}

**Signal Routing Library Block Parameters (Continued)**

<b>Block (Type)/Parameter</b>	<b>Dialog Box Prompt</b>	<b>Values</b>
OutDataTypeStr	Output data type	string {'Inherit: Inherit via internal rule'}   'Inherit: Inherit via back propagation'   'double'   'single'   'int8'   'uint8'   'int16'   'uint16'   'int32'   'uint32'
LockScale	Lock output scaling against changes by the autoscaling tool	'on'   {'off'}
RndMeth	Round integer calculations toward	'Zero'   'Nearest'   'Ceiling'   {'Floor'}
SaturateOnInteger Overflow	Saturate on integer overflow	'on'   {'off'}
SampleTime	Sample time (-1 for inherited)	string {'-1'}
<b>Mux (Mux)</b>		
Inputs	Number of inputs	string {'2'}
DisplayOption	Display option	'none'   'signals'   {'bar'}
UseBusObject	For internal use	
BusObject	For internal use	
NonVirtualBus	For internal use	
<b>Selector (Selector)</b>		
NumberOfDimensions	Number of input dimensions	string {'1'}
IndexMode	Index mode	'Zero-based'   {'One-based'}
IndexOptionArray	Index Option	'Select all'   {'Index vector (dialog)'}   'Index vector (port)'   'Starting index (dialog)'   'Starting index (port)'

**Signal Routing Library Block Parameters (Continued)**

<b>Block (Type)/Parameter</b>	<b>Dialog Box Prompt</b>	<b>Values</b>
IndexParamArray	Index	cell array
OutputSizeArray	Output Size	cell array
InputPortWidth	Input port size	string {'1'}
SampleTime	Sample time (-1 for inherited)	string {'-1'}
IndexOptions	See IndexOptionArray parameter for more information.	
Indices	See IndexParamArray parameter for more information.	
OutputSizes	See OutputSizeArray parameter for more information.	
Switch (Switch)		
Criteria	Criteria for passing first input	{'u2 >= Threshold'}   'u2 > Threshold'   'u2 ~= 0'
Threshold	Threshold	string {'0'}
InputSameDT	Require all data port inputs to have the same data type	'on'   {'off'}
OutMin	Output minimum	string {'[]'}
OutMax	Output maximum	string {'[]'}
OutDataTypeStr	Output data type	string {'Inherit: Inherit via internal rule'}   'Inherit: Inherit via back propagation'   'double'   'single'   'int8'   'uint8'   'int16'   'uint16'   'int32'   'uint32'

**Signal Routing Library Block Parameters (Continued)**

Block (Type)/Parameter	Dialog Box Prompt	Values
LockScale	Lock output scaling against changes by the autoscaling tool	'on'   {'off'}
RndMeth	Round integer calculations toward	'Zero'   'Nearest'   'Ceiling'   {'Floor'}
SaturateOnInteger Overflow	Saturate on integer overflow	'on'   {'off'}
ZeroCross	Enable zero crossing detection	{'on'}   'off'
SampleTime	Sample time (-1 for inherited)	string {'-1'}

**Sinks Library Block Parameters**

Block (Type)/Parameter	Dialog Box Prompt	Values
Display (Display)		
Format	Format	{'short'}   'long'   'short_e'   'long_e'   'bank'   'hex (Stored Integer)'   'binary (Stored Integer)'   'decimal (Stored Integer)'   'octal (Stored Integer)'
Decimation	Decimation	string {'1'}
Floating	Floating display	'on'   {'off'}
SampleTime	Sample time (-1 for inherited)	string {'-1'}
Floating Scope (Scope)		
Floating		{'on'}   'off'
Location		rectangle {'[376 294 700 533]'}

**Sinks Library Block Parameters (Continued)**

<b>Block (Type)/Parameter</b>	<b>Dialog Box Prompt</b>	<b>Values</b>
Open		'on'   {'off'}
NumInputPorts		string {'1'}
TickLabels		'on'   'off'   {'OneTimeTick'}
ZoomMode		{'on'}   'xonly'   'yonly'
AxesTitles		list
Grid		'off'   {'on'}   'xonly'   'yonly'
TimeRange		string {'auto'}
YMin		string {'-5'}
YMax		string {'5'}
SaveToWorkspace		'on'   {'off'}
SaveName		string {'ScopeData'}
DataFormat		{'StructureWithTime'}   'Structure'   'Array'
LimitDataPoints		{'on'}   'off'
MaxDataPoints		string {'5000'}
Decimation		string {'1'}
SampleInput		'on'   {'off'}
SampleTime		string {'0'}
<b>Out1 (Outputport)</b>		
Port	Port number	string {'1'}
IconDisplay	Icon display	'Signal name'   {'Port number'}   'Port number and signal name'

**Sinks Library Block Parameters (Continued)**

<b>Block (Type)/Parameter</b>	<b>Dialog Box Prompt</b>	<b>Values</b>
UseBusObject	Specify properties via bus object	'on'   {'off'}
BusObject	Bus object for validating input bus	string {'BusObject'}
BusOutputAsStruct	Output as nonvirtual bus in parent model	'on'   {'off'}
PortDimensions	Port dimensions (-1 for inherited)	string {'-1'}
SampleTime	Sample time (-1 for inherited)	string {'-1'}
OutMin	Minimum	string {'[]'}
OutMax	Maximum	string {'[]'}
OutDataTypeStr	Data type	string {'Inherit: auto'   'double'   'single'   'int8'   'uint8'   'int16'   'uint16'   'int32'   'uint32'   'boolean'}
SignalType	Signal type	{'auto'}   'real'   'complex'
SamplingMode	Sampling mode	{'auto'}   'Sample based'   'Frame based'
OutputWhenDisabled	Output when disabled	{'held'}   'reset'
InitialOutput	Initial output	string {'[]'}
<b>Scope (Scope)</b>		
Floating		'on'   {'off'}
Location		rectangle {'[188 390 512 629]'}
Open		'on'   {'off'}
NumInputPorts		string {'1'}



**Sinks Library Block Parameters (Continued)**

<b>Block (Type)/Parameter</b>	<b>Dialog Box Prompt</b>	<b>Values</b>
TickLabels		'on'   'off'   {'OneTimeTick'}
ZoomMode		{'on'}   'xonly'   'yonly'
AxesTitles		list
Grid		'off'   {'on'}   'xonly'   'yonly'
TimeRange		string {'auto'}
YMin		string {'-5'}
YMax		string {'5'}
SaveToWorkspace		'on'   {'off'}
SaveName		string {'ScopeData1'}
DataFormat		{'StructureWithTime'}   'Structure'   'Array'
LimitDataPoints		{'on'}   'off'
MaxDataPoints		string {'5000'}
Decimation		string {'1'}
SampleInput		'on'   {'off'}
SampleTime		string {'0'}
<b>Stop Simulation</b>		
<b>Terminator</b>		
<b>To File (ToFile)</b>		
Filename	Filename	string {'untitled.mat'}
MatrixName	Variable name	string {'ans'}
Decimation	Decimation	string {'1'}
SampleTime	Sample time (-1 for inherited)	string {'-1'}

**Sinks Library Block Parameters (Continued)**

<b>Block (Type)/Parameter</b>	<b>Dialog Box Prompt</b>	<b>Values</b>
To Workspace (ToWorkspace)		
VariableName	Variable name	string {'simout'}
MaxDataPoints	Limit data points to last	string {'inf'}
Decimation	Decimation	string {'1'}
SampleTime	Sample time (-1 for inherited)	string {'-1'}
SaveFormat	Save format	'Structure With Time'   { 'Structure' }   'Array'
FixptAsFi	Log fixed-point data as an fi object	'on'   {'off'}
XY Graph (XY scope) (masked subsystem)		
xmin	x-min	string {'-1'}
xmax	x-max	string {'1'}
ymin	y-min	string {'-1'}
ymax	y-max	string {'1'}
st	Sample time	string {'-1'}

**Sources Library Block Parameters**

<b>Block (Type)/Parameter</b>	<b>Dialog Box Prompt</b>	<b>Values</b>
Band-Limited White Noise (Band-Limited White Noise) (masked subsystem)		
Cov	Noise power	string {'[0.1]'}
Ts	Sample time	string {'0.1'}
seed	Seed	string {'[23341]'}
VectorParams1D	Interpret vector parameters as 1-D	{ 'on' }   'off'
Chirp Signal (chirp) (masked subsystem)		
f1	Initial frequency (Hz)	string {'0.1'}

**Sources Library Block Parameters (Continued)**

<b>Block (Type)/Parameter</b>	<b>Dialog Box Prompt</b>	<b>Values</b>
T	Target time (secs)	string {'100'}
f2	Frequency at target time (Hz)	string {'1'}
VectorParams1D	Interpret vectors parameters as 1-D	{'on'}   'off'
<b>Clock (Clock)</b>		
DisplayTime	Display time	'on'   {'off'}
Decimation	Decimation	string {'10'}
<b>Constant (Constant)</b>		
Value	Constant value	string {'1'}
VectorParams1D	Interpret vector parameters as 1-D	{'on'}   'off'
SamplingMode	Sampling mode	string {'Sample based'}   'Frame based'
OutMin	Output minimum	string {'[]'}
OutMax	Output maximum	string {'[]'}
OutDataTypeStr	Output data type	string {'Inherit: Inherit from 'Constant value''}   'Inherit: Inherit via back propagation'   'double'   'single'   'int8'   'uint8'   'int16'   'uint16'   'int32'   'uint32'   'boolean'
SampleTime	Sample time	string {'inf'}
FramePeriod	Frame period	string {'inf'}
<b>Counter Free-Running (Counter Free-Running) (masked subsystem)</b>		
NumBits	Number of Bits	string {'16'}

**Sources Library Block Parameters (Continued)**

<b>Block (Type)/Parameter</b>	<b>Dialog Box Prompt</b>	<b>Values</b>
tsamp	Sample time	string {'-1'}
Counter Limited (Counter Limited) (masked subsystem)		
uplimit	Upper limit	string {'7'}
tsamp	Sample time	string {'-1'}
Digital Clock (DigitalClock)		
SampleTime	Sample time	string {'1'}
From File (FromFile)		
FileName	Filename	string {'untitled.mat'}
SampleTime	Sample time	string {'0'}
From Workspace (FromWorkspace)		
VariableName	Data	string {'simin'}
SampleTime	Sample time	string {'0'}
Interpolate	Interpolate data	{'on'}   'off'
ZeroCross	Enable zero crossing detection	{'on'}   'off'
OutputAfterFinalValue	Form output after final data value by	{'Extrapolation'}   'Setting to zero'   'Holding final value'   'Cyclic repetition'
Ground		
In1 (Inport)		
Port	Port number	string {'1'}
IconDisplay	Icon display	'Signal name'   {'Port number'}   'Port number and signal name'
UseBusObject	Specify properties via bus object	'on'   {'off'}
BusObject	For internal use	

**Sources Library Block Parameters (Continued)**

<b>Block (Type)/Parameter</b>	<b>Dialog Box Prompt</b>	<b>Values</b>
BusOutputAsStruct	Output as nonvirtual bus	'on'   {'off'}
PortDimensions	Port dimensions (-1 for inherited)	string {'-1'}
SampleTime	Sample time (-1 for inherited)	string {'-1'}
OutMin	Minimum	string {'[]'}
OutMax	Maximum	string {'[]'}
OutDataTypeStr	Data type	string {'Inherit: auto'   'double'   'single'   'int8'   'uint8'   'int16'   'uint16'   'int32'   'uint32'   'boolean'}
SignalType	Signal type	{'auto'}   'real'   'complex'
SamplingMode	Sampling mode	{'auto'}   'Sample based'   'Frame based'
LatchByDelaying OutsideSignal	Latch input by delaying outside signal	'on'   {'off'}
LatchByCopying InsideSignal	Latch input by copying inside signal	'on'   {'off'}
Interpolate	Interpolate data	{'on'}   'off'
<b>Pulse Generator (DiscretePulseGenerator)</b>		
PulseType	Pulse type	{'Time based'}   'Sample based'
TimeSource	Time (t)	{'Use simulation time'}   'Use external signal'
Amplitude	Amplitude	string {'1'}
Period	Period	string {'2'}
PulseWidth	Pulse width	string {'50'}

**Sources Library Block Parameters (Continued)**

<b>Block (Type)/Parameter</b>	<b>Dialog Box Prompt</b>	<b>Values</b>
PhaseDelay	Phase delay	string {'0'}
SampleTime	Sample time	string {'1'}
VectorParams1D	Interpret vector parameters as 1-D	{'on'}   'off'
Ramp (Ramp) (masked subsystem)		
slope	Slope	string {'1'}
start	Start time	string {'0'}
X0	Initial output	string {'0'}
VectorParams1D	Interpret vector parameters as 1-D	{'on'}   'off'
Random Number (RandomNumber)		
Mean	Mean	string {'0'}
Variance	Variance	string {'1'}
Seed	Initial seed	string {'0'}
SampleTime	Sample time	string {'0'}
VectorParams1D	Interpret vector parameters as 1-D	{'on'}   'off'
Repeating Sequence (Repeating table) (masked subsystem)		
rep_seq_t	Time values	string {'[0 2]'}
rep_seq_y	Output values	string {'[0 2]'}
Repeating Sequence Interpolated (Repeating Sequence Interpolated) (masked subsystem)		
OutValues	Vector of output values	string {'[3 1 4 2 1].''}
TimeValues	Vector of time values	string {'[0 0.1 0.5 0.6 1].''}

**Sources Library Block Parameters (Continued)**

<b>Block (Type)/Parameter</b>	<b>Dialog Box Prompt</b>	<b>Values</b>
LookUpMeth	Lookup Method	{'Interpolation-Use End Values'}   'Use Input Nearest'   'Use Input Below'   'Use Input Above'
tsamp	Sample time	string {'0.01'}
OutMin	Output minimum	string {'[]'}
OutMax	Output maximum	string {'[]'}
OutDataTypeStr	Output data type	string {'float('double')'}   'Inherit: Inherit via back propagation'   'double'   'single'   'int8'   'uint8'   'int16'   'uint16'   'int32'   'uint32'
OutputDataTypeScaling Mode	Deprecated	
OutDataType	Deprecated	
OutScaling	Deprecated	
LockScale	Lock output scaling against changes by the autoscaling tool	'on'   {'off'}
<b>Repeating Sequence Stair (Repeating Sequence Stair) (masked subsystem)</b>		
OutValues	Vector of output values	string {'[3 1 4 2 1].''}
tsamp	Sample time	string {'-1'}
OutMin	Output minimum	string {'[]'}
OutMax	Output maximum	string {'[]'}

**Sources Library Block Parameters (Continued)**

<b>Block (Type)/Parameter</b>	<b>Dialog Box Prompt</b>	<b>Values</b>
OutDataTypeStr	Output data type	string {'float('double')'}   'Inherit: Inherit via back propagation'   'double'   'single'   'int8'   'uint8'   'int16'   'uint16'   'int32'   'uint32'
OutputDataTypeScaling Mode	Deprecated	
OutDataType	Deprecated	
ConRadixGroup	Deprecated	
OutScaling	Deprecated	
LockScale	Lock output scaling against changes by the autoscaling tool	'on'   {'off'}
Signal Builder (Sigbuilder block) (masked subsystem)		
Signal Generator (SignalGenerator)		
WaveForm	Wave form	{'sine'}   'square'   'sawtooth'   'random'
TimeSource	Time (t)	{'Use simulation time'}   'Use external signal'
Amplitude	Amplitude	string {'1'}
Frequency	Frequency	string {'1'}
Units	Units	'rad/sec'   {'Hertz'}
VectorParams1D	Interpret vector parameters as 1-D	{'on'}   'off'
Sine Wave (Sin)		
SineType	Sine type	{'Time based'}   'Sample based'



**Sources Library Block Parameters (Continued)**

<b>Block (Type)/Parameter</b>	<b>Dialog Box Prompt</b>	<b>Values</b>
TimeSource	Time (t)	{'Use simulation time'}   'Use external signal'
Amplitude	Amplitude	string {'1'}
Bias	Bias	string {'0'}
Frequency	Frequency (rad/sec)	string {'1'}
Phase	Phase (rad)	string {'0'}
Samples	Samples per period	string {'10'}
Offset	Number of offset samples	string {'0'}
SampleTime	Sample time	string {'0'}
VectorParams1D	Interpret vector parameters as 1-D	{'on'}   'off'
<b>Step (Step)</b>		
Time	Step time	string {'1'}
Before	Initial value	string {'0'}
After	Final value	string {'1'}
SampleTime	Sample time	string {'0'}
VectorParams1D	Interpret vector parameters as 1-D	{'on'}   'off'
ZeroCross	Enable zero crossing detection	{'on'}   'off'
<b>Uniform Random Number (UniformRandomNumber)</b>		
Minimum	Minimum	string {'-1'}
Maximum	Maximum	string {'1'}
Seed	Initial seed	string {'0'}

**Sources Library Block Parameters (Continued)**

Block (Type)/Parameter	Dialog Box Prompt	Values
SampleTime	Sample time	string {'0'}
VectorParams1D	Interpret vector parameters as 1-D	{'on'}   'off'

**User-Defined Functions Library Block Parameters**

Block (Type)/Parameter	Dialog Box Prompt	Values
Embedded MATLAB Fcn (Stateflow) (masked subsystem)		
Fcn (Fcn)		
Expr	Expression	string {'sin(u(1)*exp(2.3*(-u(2))))'}
SampleTime	Sample time (-1 for inherited)	string {'-1'}
Level-2 M-file S-Function (M-S-Function)		
FunctionName	M-file name	string {'mlfile'}
Parameters	Parameters	string {''}
MATLAB Fcn (MATLABFcn)		
MATLABFcn	MATLAB function	string {'sin'}
OutputDimensions	Output dimensions	string {'-1'}
OutputSignalType	Output signal type	{'auto'}   'real'   'complex'
Output1D	Collapse 2-D results to 1-D	{'on'}   'off'
SampleTime	Sample time (-1 for inherited)	string {'-1'}
S-Function (S-Function)		
FunctionName	S-function name	string {'system'}
Parameters	S-function parameters	string {''}

**User-Defined Functions Library Block Parameters (Continued)**

Block (Type)/Parameter	Dialog Box Prompt	Values
SFunctionModules	S-function modules	string {''}
S-Function Builder (S-Function Builder) (masked subsystem)		
FunctionName	S-function name	string {'system'}
Parameters	S-function parameters	string {''}
SFunctionModules	S-function modules	string {''}

**Additional Discrete Block Library Parameters**

Block (Type)/Parameter	Dialog Box Prompt	Values
Fixed-Point State-Space (Fixed-Point State-Space) (masked subsystem)		
A	State Matrix A	string {'[2.6020 -2.2793 0.6708; 1 0 0; 0 1 0]'} '}
B	Input Matrix B	string {'[ 1; 0; 0]'} '}
C	Output Matrix C	string {'[0.0184 0.0024 0.0055]'} '}
D	Direct Feedthrough Matrix D	string {'[0.0033]'} '}
X0	Initial condition for state	string {'0.0'}
InternalDataType	Data type for internal calculations: ex. sfix(16), uint(8), float('single')	string {'float('double')'} '}
StateEqScaling	Scaling for State Equation AX+BU: ex. 2 <sup>-9</sup>	string {'2^0'}
OutputEqScaling	Scaling for Output Equation CX+DU: ex. 2 <sup>-9</sup>	string {'2^0'}
LockScale	Lock output scaling against changes by the autoscaling tool	'on'   {'off'}
RndMeth	Round toward	'Zero'   'Nearest'   'Ceiling'   {'Floor'}

**Additional Discrete Block Library Parameters (Continued)**

<b>Block (Type)/Parameter</b>	<b>Dialog Box Prompt</b>	<b>Values</b>
DoSatur	Saturate to max or min when overflows occur	'on'   {'off'}
Transfer Fcn Direct Form II (Transfer Fcn Direct Form II) (masked subsystem)		
NumCoefVec	Numerator coefficients	string {'[0.2 0.3 0.2]'}
DenCoefVec	Denominator coefficients excluding lead (which must be 1.0)	string {'[-0.9 0.6]'}
vinit	Initial condition	string {'0.0'}
RndMeth	Round toward	'Zero'   'Nearest'   'Ceiling'   {'Floor'}
DoSatur	Saturate to max or min when overflows occur	'on'   {'off'}
Transfer Fcn Direct Form II Time Varying (Transfer Fcn Direct Form II Time Varying) (masked subsystem)		
vinit	Initial condition	string {'0.0'}
RndMeth	Round toward	'Zero'   'Nearest'   'Ceiling'   {'Floor'}
DoSatur	Saturate to max or min when overflows occur	'on'   {'off'}
Unit Delay Enabled (Unit Delay Enabled) (masked subsystem)		
vinit	Initial condition	string {'0.0'}
tsamp	Sample time	string {'-1'}
Unit Delay Enabled External IC (Unit Delay Enabled External Initial Condition) (masked subsystem)		
tsamp	Sample time	string {'-1'}
Unit Delay Enabled Resettable (Unit Delay Enabled Resettable) (masked subsystem)		
vinit	Initial condition	string {'0.0'}

**Additional Discrete Block Library Parameters (Continued)**

<b>Block (Type)/Parameter</b>	<b>Dialog Box Prompt</b>	<b>Values</b>
tsamp	Sample time	string {'-1'}
Unit Delay Enabled Resettable External IC (Unit Delay Enabled Resettable External Initial Condition) (masked subsystem)		
tsamp	Sample time	string {'-1'}
Unit Delay External IC (Unit Delay External Initial Condition) (masked subsystem)		
tsamp	Sample time	string {'-1'}
Unit Delay Resettable (Unit Delay Resettable) (masked subsystem)		
vinit	Initial condition	string {'0.0'}
tsamp	Sample time	string {'-1'}
Unit Delay Resettable External IC (Unit Delay Resettable External Initial Condition) (masked subsystem)		
tsamp	Sample time	string {'-1'}
Unit Delay With Preview Enabled (Unit Delay With Preview Enabled) (masked subsystem)		
vinit	Initial condition	string {'0.0'}
tsamp	Sample time	string {'-1'}
Unit Delay With Preview Enabled Resettable (Unit Delay With Preview Enabled Resettable) (masked subsystem)		
vinit	Initial condition	string {'0.0'}
tsamp	Sample time	string {'-1'}
Unit Delay With Preview Enabled Resettable External RV (Unit Delay With Preview Enabled Resettable External RV) (masked subsystem)		
vinit	Initial condition	string {'0.0'}
tsamp	Sample time	string {'-1'}
Unit Delay With Preview Resettable (Unit Delay With Preview Resettable) (masked subsystem)		

**Additional Discrete Block Library Parameters (Continued)**

<b>Block (Type)/Parameter</b>	<b>Dialog Box Prompt</b>	<b>Values</b>
vinit	Initial condition	string {'0.0'}
tsamp	Sample time	string {'-1'}
Unit Delay With Preview Resettable External RV (Unit Delay With Preview Resettable External RV) (masked subsystem)		
vinit	Initial condition	string {'0.0'}
tsamp	Sample time	string {'-1'}

**Additional Math: Increment - Decrement Block Parameters**

<b>Block (Type)/Parameter</b>	<b>Dialog Box Prompt</b>	<b>Values</b>
Decrement Real World (Real World Value Decrement) (masked subsystem)		
Decrement Stored Integer (Stored Integer Value Decrement) (masked subsystem)		
Decrement Time To Zero (Decrement Time To Zero) (masked subsystem)		
Decrement To Zero (Decrement To Zero) (masked subsystem)		
Increment Real World (Real World Value Increment) (masked subsystem)		
Increment Stored Integer (Stored Integer Value Increment) (masked subsystem)		

## Mask Parameters

### In this section...

“About Mask Parameters” on page 8-183

“Setting Mask Parameters” on page 8-188

“How Masked Parameters are Stored” on page 8-188

### About Mask Parameters

This section lists parameters that describe masked blocks. This table lists masking parameters, which correspond to Mask Editor dialog box parameters (see “Setting Mask Parameters” on page 8-188).

#### Mask Parameters

Parameter	Description/Prompt	Values
Mask	Turns mask on or off.	{ 'on' }   'off'
MaskCallbackString	Mask parameter callbacks that are executed when the respective parameter is changed on the dialog. Set by the <b>Dialog callback</b> field on the <b>Parameters</b> pane of the Mask Editor dialog box.	pipe-delimited string { ' ' }
MaskCallbacks	Cell array version of MaskCallbackString.	cell array { ' [ ] ' }
MaskDescription	Block description. Set by the <b>Mask description</b> field on the <b>Documentation</b> pane of the Mask Editor dialog box.	string { ' ' }
MaskDisplay	Drawing commands for the block icon. Set by the <b>Drawing commands</b> field on the <b>Icon</b> pane of the Mask Editor dialog box.	string { ' ' }

**Mask Parameters (Continued)**

<b>Parameter</b>	<b>Description/Prompt</b>	<b>Values</b>
MaskEditorHandle	For internal use.	
MaskEnableString	Option that determines whether a parameter is greyed out in the dialog. Set by the <b>Enable parameter</b> check box on the <b>Parameters</b> pane of the Mask Editor dialog box.	pipe-delimited string {' '}
MaskEnables	Cell array version of MaskEnableString.	cell array of strings, each either 'on' or 'off' {'[]'}
MaskHelp	Block help. Set by the <b>Mask help</b> field on the <b>Documentation</b> pane of the Mask Editor dialog box.	string {' '}
MaskIconFrame	Set the visibility of the icon frame (Visible is on, Invisible is off). Set by the <b>Frame</b> option on the <b>Icon</b> pane of the Mask Editor dialog box.	{'on'}   'off'
MaskIconOpaque	Set the transparency of the icon (Opaque is on, Transparent is off). Set by the <b>Transparency</b> option on the <b>Icon</b> pane of the Mask Editor dialog box.	{'on'}   'off'
MaskIconRotate	Set the rotation of the icon (Rotates is on, Fixed is off). Set by the <b>Rotation</b> option on the <b>Icon</b> pane of the Mask Editor dialog box.	'on'   {'off'}
MaskIconUnits	Set the units for the drawing commands. Set by the <b>Units</b> option on the <b>Icon</b> pane of the Mask Editor dialog box.	'pixel'   {'autoscale'}   'normalized'



**Mask Parameters (Continued)**

<b>Parameter</b>	<b>Description/Prompt</b>	<b>Values</b>
MaskInitialization	Initialization commands. Set by the <b>Initialization commands</b> field on the <b>Initialization</b> pane of the Mask Editor dialog box.	MATLAB command {''}
MaskNames	Cell array of mask dialog parameter names. Set inside the <b>Variable</b> column in the <b>Parameters</b> pane of the Mask Editor dialog box.	matrix {' []'}
MaskPrompts	List of dialog parameter prompts (see below). Set inside the <b>Dialog parameters</b> area on the <b>Parameters</b> pane of the Mask Editor dialog box.	cell array of strings {' []'}
MaskPromptString	List of dialog parameter prompts (see below). Set inside the <b>Dialog parameters</b> area on the <b>Parameters</b> pane of the Mask Editor dialog box.	string {''}
MaskPropertyNameString	Pipe-delimited version of <b>MaskNames</b> .	string {''}
MaskRunInitForIconRedraw	For internal use.	
MaskSelfModifiable	Indicates that the block can modify itself. Set by the <b>Allow library block to modify its contents</b> check box on the <b>Initialization</b> pane of the Mask Editor dialog box.	'on'   {'off'}

**Mask Parameters (Continued)**

<b>Parameter</b>	<b>Description/Prompt</b>	<b>Values</b>
MaskStyles	Determines whether the dialog parameter is a check box, edit field, or pop-up list. Set by the <b>Type</b> column in the <b>Parameters</b> pane of the Mask Editor dialog box.	cell array { ' []' }
MaskStyleString	Comma-separated version of <b>MaskStyles</b> .	string { ' ' }
MaskTabNameString	For internal use.	
MaskTabNames	For internal use.	
MaskToolTipsDisplay	Determines which mask dialog parameters to display in the data tip for this masked block (see "Block Data Tips" in the Using Simulink documentation). Specify as a cell array of 'on' or 'off' values, each of which indicates whether to display the parameter named at the corresponding position in the cell array returned by MaskNames.	cell array of 'on' and 'off' {''}
MaskToolTipString	Comma-delimited version of MaskToolTipsDisplay.	string { ' ' }
MaskTunableValues	Allows the changing of mask dialog values during simulation. Set by the <b>Tunable</b> column in the <b>Parameters</b> pane of the Mask Editor dialog box.	cell array of strings { ' []' }

**Mask Parameters (Continued)**

<b>Parameter</b>	<b>Description/Prompt</b>	<b>Values</b>
MaskTunableValueString	Comma-delimited string version of MaskTunableValues.	delimited string {''}
MaskType	Mask type. Set by the <b>Mask type</b> field on the <b>Documentation</b> pane of the Mask Editor dialog box.	string {'Stateflow'}
MaskValues	Dialog parameter values.	cell array {'[]'}
MaskValueString	Delimited string version of MaskValues.	delimited string {''}
MaskVarAliases	Specify aliases for a block's mask parameters. The aliases must appear in the same order as the parameters appear in the block's MaskValues parameter.	cell array {'[]'}
MaskVarAliasString	For internal use.	
MaskVariables	List of the dialog parameters' variables (see below). Set inside the <b>Dialog parameters</b> area on the <b>Parameters</b> pane of the Mask Editor dialog box.	string {''}
MaskVisibilities	Specifies visibility of parameters. Set with the <b>Show parameter</b> check box in the <b>Options for selected parameter</b> area on the <b>Parameters</b> pane of the Mask Editor dialog box.	matrix {'[]'}

## Mask Parameters (Continued)

Parameter	Description/Prompt	Values
MaskVisibilityString	Delimited string version of MaskVisibilities.	string { ' ' }
MaskWSVariables	List of the variables defined in the mask workspace (read only).	matrix { ' [ ] ' }

## Setting Mask Parameters

When you use the Mask Editor to create a dialog box parameter for a masked block, you provide this information:

- The prompt, which you enter in the **Prompt** field
- The variable that holds the parameter value, which you enter in the **Variable** field
- The type of field created, which you specify by selecting a control **Type**
- Whether the value entered in the field is to be evaluated or stored as a literal, which you specify by selecting an **Evaluate** type

## How Masked Parameters are Stored

The mask parameters, listed in the preceding table, store the values specified for the dialog box parameters in these ways:

- The **Prompt** field values for all dialog box parameters are stored in the MaskPromptString parameter as a string, with individual values separated by a vertical bar (|), as shown in this example:

```
"Slope: | Intercept: "
```

- The **Variable** field values for all dialog box parameters are stored in the MaskVariables parameter as a string, with individual assignments separated by a semicolon. A sequence number indicates the prompt that is associated with a variable. A special character preceding the sequence

number indicates the **Evaluate** type: @ indicates **Evaluate**, & indicates **Literal**.

For example, "a=@1;b=&2;" indicates that the value entered in the first parameter field is assigned to variable a and is evaluated in MATLAB before assignment, and the value entered in the second field is assigned to variable b and is stored as a literal, which means that its value is the string entered in the dialog box.

- The control **Type** field values for all dialog box parameters are stored in the MaskStyleString parameter as a string, with individual values separated by a comma. The **Popup strings** values appear after the popup type, as shown in this example:

```
"edit,checkbox,popup(red|blue|green) "
```

- The parameter values are stored in the MaskValueString mask parameter as a string, with individual values separated by a vertical bar. The order of the values is the same as the order in which the parameters appear on the dialog box. For example, these statements define values for the parameter field prompts and the values for those parameters:

```
MaskPromptString    "Slope: | Intercept: "  
MaskValueString     "2|5"
```



# Model File Format

---

Model File Contents (p. 9-2)

File formats for Simulink

## Model File Contents

In this section...
“About Model File Formats” on page 9-2
“Model Section” on page 9-4
“Simulink.ConfigSet Section” on page 9-5
“BlockDefaults Section” on page 9-5
“BlockParameterDefaults Section” on page 9-6
“AnnotationDefaults Section” on page 9-7
“LineDefaults Section” on page 9-7
“System Section” on page 9-7

### About Model File Formats

A model file is a structured ASCII file that contains keywords and parameter-value pairs that describe the model. The file describes model components in hierarchical order.

The structure of the model file is as follows.

```

Model {
  <Model Parameter Name> <Model Parameter Value>
  ...
  Array {
    Simulink.ConfigSet {
      $ObjectID <Object ID>
      <ConfigSet Parameter Name> <ConfigSet Parameter Value>
      ...
    }
  }
  Simulink.ConfigSet {
    $PropName "ActiveConfigurationSet"
    $ObjectID <Object ID>
  }
  BlockDefaults {
    <Block Parameter Name> <Block Parameter Value>
  }
}

```



```
    ...
  }
  BlockParameterDefaults {
    Block {
      <Block Parameter Name> <Block Parameter Value>
      ...
    }
  }
  AnnotationDefaults {
    <Annotation Parameter Name> <Annotation Parameter Value>
    ...
  }
  LineDefaults {
    <Line Parameter Name> <Line Parameter Value>
    ...
  }
  System {
    <System Parameter Name> <System Parameter Value>
    ...
    Block {
      <Block Parameter Name> <Block Parameter Value>
      ...
    }
    Line {
      <Line Parameter Name> <Line Parameter Value>
      ...
      Branch {
        <Branch Parameter Name> <Branch Parameter Value>
        ...
      }
    }
    Annotation {
      <Annotation Parameter Name> <Annotation Parameter Value>
      ...
    }
  }
}
```

See Chapter 8, “Model and Block Parameters” for descriptions of model and block parameters.

This reference contains examples of each section, extracted from the model file of the following model:

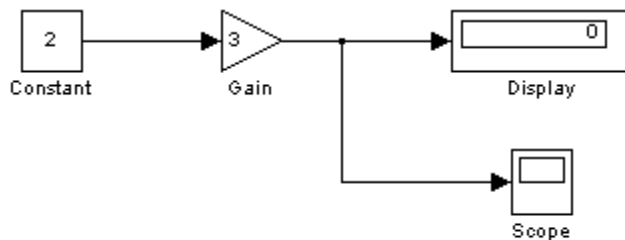

This model generates...

## Model Section

The Model section, located at the top of the model file, contains all other sections of the model file and defines the values for model-level parameters. These parameters include the model name, the version of Simulink last used to modify the model, and configuration set parameters (see “Configuration Sets” in the online Simulink documentation) among others.

The following example shows parts of the Model section for a model.

```

Model {
  Name          "my_model"
  Version       6.4
  MdlSubVersion 0
  GraphicalInterface {
    NumRootInports      0
    NumRootOutports     0
    ParameterArgumentNames ""
    ComputedModelVersion "1.10"
    NumModelReferences  0
    NumTestPointedSignals 0
  }
  SavedCharacterEncoding "windows-1252"
  SaveDefaultBlockParams on
  ...
  Array {
    Type          "Handle"
  }
}
  
```

```

Dimension          2
Simulink.ConfigSet {
  $ObjectID        1
  Version          "1.2.0"
  Array {
    Type           "Handle"
    Dimension      7
    Simulink.SolverCC {
      ...
    }
    ...
  }
  ...
}
...
}
...
}
...
}

```

## Simulink.ConfigSet Section

The `Simulink.ConfigSet` section appears after the configuration set parameters. This section identifies the active configuration set for the model (see “The Active Set” in the online Simulink documentation).

The following example shows the `Simulink.ConfigSet` section for a model.

```

Simulink.ConfigSet {
  $PropName        "ActiveConfigurationSet"
  $ObjectID        1
}

```

## BlockDefaults Section

The `BlockDefaults` section appears after the `Simulink.ConfigSet` section. This section defines the default values for common block parameters in the model. These values can be overridden by individual block parameters, defined in `Block` subsections of `System` sections.

The following example shows the `BlockDefaults` section for a model.

```

BlockDefaults {

```

```
Orientation      "right"
ForegroundColor  "black"
BackgroundColor  "white"
DropShadow      off
NamePlacement   "normal"
FontName        "Arial"
FontSize        10
FontWeight      "normal"
FontAngle       "normal"
ShowName        on
}
```

## BlockParameterDefaults Section

The `BlockParameterDefaults` section appears after the `BlockDefaults` section. This section defines the default values for block-specific parameters using `Block` subsections. Each `Block` subsection defines the default parameter-value pairs for a particular type of block in the model. These values can be overridden by individual block parameters, defined in `Block` subsections of `System` sections.

The following example shows part of the `BlockParameterDefaults` section for a model.

```
BlockParameterDefaults {
  Block {
    BlockType      Constant
  }
  Block {
    BlockType      Display
    Format          "short"
    Decimation     "10"
    Floating       off
    SampleTime     "-1"
  }
  ...
}
```

## AnnotationDefaults Section

The AnnotationDefaults section appears after the BlockParameterDefaults section. This section defines the default parameters for all annotations in the model (see Simulink.Annotation).

The following example shows the AnnotationDefaults section for a model.

```
AnnotationDefaults {
  HorizontalAlignment    "center"
  VerticalAlignment     "middle"
  ForegroundColor       "black"
  BackgroundColor       "white"
  DropShadow            off
  FontName               "Courier New"
  FontSize               10
  FontWeight             "normal"
  FontAngle              "normal"
}
```

## LineDefaults Section

The LineDefaults section appears after the AnnotationDefaults section. This section defines the default parameters for all lines in the model.

The following example shows the LineDefaults section for a model.

```
LineDefaults {
  FontName               "Courier New"
  FontSize               9
  FontWeight             "normal"
  FontAngle              "normal"
}
```

## System Section

The top-level system and each subsystem in the model are described in a separate System section. Each System section defines system-level parameters and includes Block, Line, and Annotation sections for each block, line, and annotation in the system. Each Line that contains a branch point includes a Branch section that defines the branch line.

The following example shows parts of the System section for a model.

```
System {
  Name           "my_model"
  Location       [480, 85, 1206, 386]
  Open           on
  ModelBrowserVisibility off
  ModelBrowserWidth 200
  ScreenColor    "white"
  PaperOrientation "landscape"
  ...
  Block {
    BlockType      Constant
    Name           "Constant"
    Position       [65, 100, 95, 130]
    Value          "2"
    ...
  }
  ...
  Line {
    SrcBlock       "Gain"
    SrcPort        1
    Points         [25, 0]
    Branch {
      Points       [0, 70]
      DstBlock     "Scope"
      DstPort      1
    }
    Branch {
      Points       [20, 0]
      DstBlock     "Display"
      DstPort      1
    }
  }
  ...
}
```

```
Annotation {  
  Name          "This model generates..."  
  Position      [149, 234]  
  UseDisplayTextAsClickCallback off  
}  
}
```





# Model Advisor Checks

---

Simulink Checks (p. 10-2)

Describes Model Advisor Checks for  
Simulink

## Simulink Checks

<b>In this section...</b>
“Simulink Overview” on page 10-3
“Check model, local libraries, and referenced models for known upgrade issues” on page 10-3
“Identify unconnected lines, input ports, and output ports” on page 10-5
“Check root model Inport block specifications” on page 10-6
“Check optimization settings” on page 10-7
“Check for parameter tunability information ignored for referenced models” on page 10-8
“Check for implicit signal resolution” on page 10-9
“Check for optimal bus virtuality” on page 10-10
“Check for Discrete-Time Integrator blocks with initial condition uncertainty” on page 10-11
“Identify disabled library links” on page 10-12
“Identify parameterized library links” on page 10-13
“Check for proper bus usage” on page 10-14
“Check for potentially delayed function-call subsystem return values” on page 10-15
“Identify block output signals with continuous sample time and non-floating point data type” on page 10-16
“Check for proper Merge block usage” on page 10-17

## Simulink Overview

Use the Simulink Model Advisor checks to configure your model for simulation.

### See Also

- Consulting Model Advisor in the Simulink documentation.
- Real-Time Workshop Model Advisor Check Reference in the Simulink documentation.
- Simulink Verification and Validation Model Advisor Check Reference.

## Check model, local libraries, and referenced models for known upgrade issues

Uses the `supdate` command analysis mode to check for common upgrade issues.

### Description

Check blocks, settings, and references in the model for compatibility issues resulting from using a new version of Simulink.

### Results and Recommended Actions

Condition	Recommended Action
Referenced models recommended for update.	Run Simulink update tool, <code>supdate</code> on the listed models.
Check library update status.	Verify that indicated libraries are valid.
Check update status for the Level 2 API S-functions.	Consider replacing Level 1 S-functions with Level 2.
Blocks have configuration sets or ports with undesired settings.	Run Simulink update tool, <code>supdate</code> in update mode.

### See Also

- `supdate` in the Simulink documentation.
- *Writing S-Functions* in the Simulink documentation.

## Identify unconnected lines, input ports, and output ports

Check for unconnected lines or ports.

### Description

This check lists unconnected lines or ports. These can have difficulty propagating signal attributes such as data type, sample time, and dimensions.

---

**Note** Ports connected to ground/terminator blocks will pass this test.

---

### Results and Recommended Actions

Condition	Recommended Action
Lines, input ports, or output ports are unconnected.	Ensure all signals are connected. Double-click the list of unconnected items to locate failure.

### Tips

Use the `PortConnectivity` command to obtain an array of structures describing block input or output ports.

### See Also

“Common Block Parameters” on page 8-66 in the Simulink documentation for information on the `PortConnectivity` command.

## Check root model Inport block specifications

Check that root model Inport blocks fully define dimensions, sample time, and data type.

### Description

Using root model Inport blocks that do not fully define dimensions, sample time, or data type can lead to undesired simulation results. Simulink back-propagates dimensions, sample times and data types from downstream blocks unless you explicitly assign them values.

### Results and Recommended Actions

Condition	Recommended Action
Root-level Inport blocks have undefined attributes.	Fully define the attributes of all root-level Inport blocks.

### See Also

- “Working with Data Types” in the Simulink documentation.
- “Determining Output Signal Dimensions” in the Simulink documentation.
- “Specifying Sample Time” in the Simulink documentation.

## Check optimization settings

Unselected optimizations during code generation can lead to suboptimal results.

### Description

This check lists code generation optimizations that have been turned off. Turning them on can improve code efficiency and simulation time.

### Results and Recommended Actions

Condition	Recommended Action
Listed optimizations not selected.	Turn on the listed optimizations in the Optimization pane Configurations Parameters dialog box.

## Check for parameter tunability information ignored for referenced models

Checks if parameter tunability information is included in the Model Parameter Configuration dialog box.

### Description

Simulink ignores tunability information specified in the Model Parameter Configuration dialog box. This check identifies those models containing parameter tunability information that Simulink will ignore if the model is referenced by other models.

### Results and Recommended Actions

Condition	Recommended Action
Model contains ignored parameter tunability information.	Click the links to convert to equivalent Simulink parameter objects in the MATLAB workspace.

### See Also

“Parameter Storage, Interfacing, and Tuning” in the Simulink documentation.



## Check for implicit signal resolution

Identify models that attempt to resolve named signals and states to Simulink.Signal objects.

### Description

Requiring Simulink to resolve all named signals and states is inefficient and slows incremental code generation and model reference. This check identifies those signals and states for which you may turn off implicit signal resolution and enforce resolution.

### Results and Recommended Actions

Condition	Recommended Action
Not all signals and states are resolved.	Turn off implicit signal resolution and enforce resolution for each signal and state that successfully resolves.

### See Also

“Resolving Signal Objects for Output Data” in the Simulink documentation.

## Check for optimal bus virtuality

Identify virtual buses that could be made nonvirtual. Making these buses nonvirtual improves generated code efficiency.

### Description

This check identifies blocks incorporating virtual buses that cross a model boundary. Changing these to nonvirtual improves generated code efficiency.

### Results and Recommended Actions

Condition	Recommended Action
Blocks that specify a virtual bus crossing a model boundary.	Change the highlighted bus to nonvirtual.

### See Also

- “Working with Signals” in the Simulink documentation.
- “Virtual and Nonvirtual Buses” in the Simulink documentation.

## Check for Discrete-Time Integrator blocks with initial condition uncertainty

Identify Discrete-Time Integrator blocks with state port and initial condition ports that are fed by neither an Initial Condition nor a Constant block.

### Description

Discrete-Time Integrator blocks with state port and initial condition ports might not be properly initialized unless they are fed from an Initial Condition or Constant block. This is more likely to happen when Discrete-Time Integrator blocks are used to model second-order or higher-order dynamic systems.

### Results and Recommended Actions

Condition	Recommended Action
Discrete-Time Integrator blocks are not initialized during the model initialization phase.	Add a Constant or Initial Condition block to feed the external Initial Condition port.

### See Also

- IC block
- Integrator block
- Constant block

## Identify disabled library links

Search model for disabled library links.

### Description

Disabled library links can cause unexpected simulation results. All disabled links should be resolved before a model is saved.

---

**Note** This check may overlap with “Check model, local libraries, and referenced models for known upgrade issues” on page 10-3.

---

### Results and Recommended Actions

Condition	Recommended Action
Library links are disabled.	Use Restore Link from the Link Options setting in the context menu.

### Tips

- Use the Model Browser to find library links.
- To enable a broken link, right-click a block in your model to display the context menu. Choose Link Options and click Restore Link.

### See Also

“The Model Browser” in the Simulink documentation.

## Identify parameterized library links

Search model for parameterized library links.

### Description

Parameterized library links that are unintentional can result in unexpected parameter settings in your model. This can result in improper model operation.

### Results and Recommended Actions

Condition	Recommended Action
Parameterized links are listed.	Verify that all parameterized links are intended.

### Tips

- Right-click a block in your model to display the context menu. Choose **Link Options** and click **Go To Library Block** to see the original block from the library.
- To parameterize a library link, choose **Look Under Mask**, from the context menu and select the parameter.

### See Also

“Creating Block Masks” in the Simulink documentation.

## Check for proper bus usage

Identify Mux blocks used as a bus creator and any bus signal that is treated as a vector.

### Description

Models should not contain bus signals that Simulink implicitly converts to vectors. Instead, either insert a Bus to Vector conversion block between the bus signal and the block input port that it feeds, or use the `Simulink.BlockDiagram.addBusToVector` command.

### Results and Recommended Actions

Condition	Recommended Action
Identify signals used as vectors.	In the Configuration Parameters dialog box, set Mux blocks used to create bus signals to error.
Model uses buses properly.	In the Configuration Parameters dialog set Bus signal treated as vector to error.
Bus signals are implicitly converted to vectors.	Use <code>Simulink.BlockDiagram.addBusToVector</code> or insert a Bus to Vector block.

### Tips

The Bus to Vector conversion block is located in the Simulink/Signal Attributes library.

### See Also

- Bus to Vector block
- `Simulink.BlockDiagram.addBusToVector` in the Simulink documentation.

## Check for potentially delayed function-call subsystem return values

Identify function-call return values that might be delayed because Simulink inserted an implicit Signal Conversion block.

### Description

To ensure that signals reside in contiguous memory, Simulink can automatically insert an implicit Signal Conversion block in front of function-call initiator block input ports. This can result in a one-step delay in returning signal values from calling function-call subsystems. The delay can be avoided by ensuring the signal originates from a signal block within the function-call system. Or, if the delay is acceptable, insert a Unit Delay block in front of the affected input ports.

### Results and Recommended Actions

Condition	Recommended Action
The listed block input ports could have an implicit Signal Conversion block.	Decide if a one-step delay in returning signal values is acceptable for the listed signals. <ul style="list-style-type: none"> <li>• If the delay is not acceptable, rework your model so that the input signal originates from within the calling subsystem.</li> <li>• If the delay is acceptable, insert a Unit Delay block in front of each listed input port.</li> </ul>

### See Also

Signal Conversion block

Unit Delay block

## Identify block output signals with continuous sample time and non-floating point data type

Find continuous sample time, non-floating-point output signals.

### Description

Non-floating-point signals cannot properly represent continuous variables.

### Results and Recommended Actions

Condition	Recommended Action
Signals with continuous sample times have a non-floating-point data type.	On the identified signals, either change the sample time to be discrete or fixed-in-minor-step ([0 1]).

### See Also

“Modeling and Simulating Discrete Systems” in the Simulink documentation.



## Check for proper Merge block usage

Analyze Merge blocks in the same tree as a group, and determine the possibility for them to execute at the same time step.

### Description

Blocks that directly drive the same tree of Merge blocks should have mutually exclusive execution in each time step. This check identifies those blocks that drive the same tree of Merge blocks, and so are likely to execute at the same time step.

### Results and Recommended Actions

Condition	Recommended Action
Merge blocks can be interconnected to form a tree structure.	Rework your model so that no blocks drive the same tree of Merge blocks.

### See Also

Merge block



## A

- Abs block 1-8 2-2
- absolute tolerance
  - simset parameter 4-145
  - specifying for a block state 2-370
- absolute value
  - generating 2-2
- Accumulator Resettable block 2-6
- Accumulator Resettable Limited block 2-6
- Action Port block 1-11 2-7
- Action subsystems
  - creating 2-7
  - with If block 2-332
  - with SwitchCase block 2-686
- Add block 2-675
- add\_block command 3-2 4-2
- add\_line command 3-2 4-6
- add\_param command 3-2 4-8
- Additional Discrete block library
  - block parameters 8-179
- Additional Math: Increment - Decrement block library
  - block parameters 8-182
- addterms command 3-2 4-9
- Algebraic Constraint block 1-8 2-11
- algebraic equations
  - modeling 2-11
- algebraic loops
  - integrator block reset or IC port 2-229
- analysis functions
  - perturbing model 2-349
- animate 6-6
- AnnotationDefaults section of mdl file 9-7
- annotations
  - annotation block. *See* Model Info block
- ashow debug command 6-7
- Assert block 1-10 2-13
- Assignment block 1-8 2-16
- Atomic Subsystem block 2-663
- atrace debug command 6-8

- attachConfigSet command 3-2 4-10
- attachConfigSetCopy command 3-2 4-12
- automatic scaling 4-58
  - and Look-Up Table (2D) block 2-415
  - autoscale safety margin 4-69
  - fixptbestprec 4-56
- autoscaling
  - fixptbestprec 4-56
- autoscaling Scope axes 2-591

## B

- Backlash block 1-3 2-23
- Backward Euler method 2-226
- Backward Rectangular method 2-226
- Band-Limited White Noise block 1-15 2-30
- bdclose command 3-2 4-14
- bdroot command 3-2 4-15
- bits
  - clear 2-41
  - mask 2-41
  - set 2-41
- block dialog boxes
  - closing 3-2 4-16
  - opening 3-3 4-113
- block parameters
  - Additional Discrete library 8-179
  - Additional Math: Increment - Decrement library 8-182
  - changing during simulation 4-124
  - common 8-66
  - Continuous library 8-80
  - Discontinuities library 8-83
  - Discrete library 8-86
  - Logic and Bit Operations library 8-96
  - Lookup Tables library 8-100
  - Math library 8-107
  - Model Verification block library 8-123
  - Model-Wide Utilities library 8-127
  - Ports & Subsystems library 8-129

- Signal Attributes library 8-153
  - Signal Routing library 8-159
  - Sinks library 8-166
  - Sources library 8-170
  - User-defined functions library 8-178
  - Block Support Table block 2-45
  - BlockDefaults section of mdl file 9-5
  - BlockParameterDefaults section of mdl file 9-6
  - blocks 8-79
    - Accumulator Resettable 2-6
    - Accumulator Resettable Limited 2-6
    - adding to model 3-2 4-2
    - Compare To Zero 2-107
    - Counter Limited 2-129
    - current 3-3 4-77
    - Data Type Propagation 2-157
    - Decrement Stored Integer 2-177
    - Decrement Time To Zero 2-178
    - Decrement To Zero 2-179
    - deleting
      - delete\_block command 3-2 4-20
    - Detect Decrease 2-192
    - Detect Fall Negative 2-194
    - Detect Fall Nonpositive 2-195
    - Detect Increase 2-197
    - Detect Rise Nonnegative 2-199
    - Detect Rise Positive 2-201
    - Filter Direct Form II 2-714
    - Filter Direct Form II Time Varying 2-717
    - Filter First Order 2-720
    - Filter Lead or Lag 2-722
    - Filter Real Zero 2-725
    - handle of current 3-3 4-78
    - Increment Stored Integer 2-346
    - Index Vector 2-347
    - Interval Test Dynamic 2-391
    - Product of Elements Inverted 2-519
    - Repeating Sequence Stair 2-569
    - Sample Time Divide 2-799
    - Sample Time Multiply 2-800
    - Sample Time Probe 2-800
    - Sample Time Subtract 2-800
    - Unit Delay Enabled External IC 2-756
    - Unit Delay Enabled Resettable 2-758
    - Unit Delay Enabled Resettable External IC 2-761
    - Unit Delay External IC 2-764
    - Unit Delay Resettable 2-766
    - Unit Delay Resettable External IC 2-768
    - Unit Delay With Preview Enabled 2-770
    - Unit Delay With Preview Enabled Resettable 2-773
    - Unit Delay With Preview Enabled Resettable External RV 2-776
    - Unit Delay With Preview Resettable 2-779
    - Unit Delay With Preview Resettable External RV 2-782
    - See also* block parameters
  - bode function 4-100
  - Boolean expressions
    - modeling 2-99
  - break debug command 6-11
  - bshow debug command 6-13
  - Bus Assignment block 1-14 2-46
  - Bus Creator block 1-2 1-14 2-49
  - Bus Selector block 1-2 1-14 2-55
  - Bus to Vector block 1-13 2-58
- ## C
- capping unconnected blocks
    - using the Terminator block 2-695
  - character encoding, model 4-179
  - Check Discrete Gradient block 1-10 2-60
  - Check Dynamic Gap block 1-10 2-63
  - Check Dynamic Lower Bound block 1-10 2-66
  - Check Dynamic Range block 1-10 2-69
  - Check Dynamic Upper Bound block 1-10 2-72
  - Check Input Resolution block 1-10 2-75
  - Check Static Gap block 1-10 2-78

- Check Static Lower Bound block 1-10 2-82
  - Check Static Range block 1-10 2-86
  - Check Static Upper Bound block 1-10 2-90
  - Chirp Signal block 1-15 2-94
  - clear debug command 6-14
  - clearing bits 2-41
  - Clock block 1-15 2-97
  - close\_system command 3-2 4-16
  - closeDialog command 3-2 4-19
  - clutch demo 2-326
  - code generation
    - scaling 2-151
  - color command 5-4
  - Combinatorial Logic block 1-5 2-99
  - combining input lines into vector line 2-483
  - commands, simulation
    - Simulink.BlockDiagram.getChecksum 4-158
    - Simulink.BlockDiagram.getInitialState 4-161
    - Simulink.SubSystem.getChecksum 4-173
  - Compare To Zero block 2-107
  - Complex to Magnitude-Angle block 1-8 2-109
  - Complex to Real-Imag block 1-8 2-111
  - Configurable Subsystem block 1-11 2-113
  - configuration parameters
    - closing dialog 3-2 4-19
    - opening dialog 3-3 4-116
  - configuration reference
    - activating 3-3 4-126
    - attaching 3-2 4-10
    - copying and attaching 3-2 4-12
    - detaching 3-2 4-23
    - obtaining 3-3 4-85
      - active 3-3 4-83
      - list of names 3-3 4-86
  - configuration set
    - activating 3-3 4-126
    - attaching 3-2 4-10
    - copying and attaching 3-2 4-12
    - detaching 3-2 4-23
    - obtaining 3-3 4-85
      - active 3-3 4-83
      - list of names 3-3 4-86
  - Constant block 1-2 1-15 2-119
  - constant value
    - generating 2-119
  - continue debug command 6-15
  - Continuous block library
    - block parameters 8-80
  - control flow diagrams
    - Action subsystem 2-7
    - do-while
      - While Iterator block 2-804
    - for
      - For Iterator block 2-284
    - if-else
      - If block 2-332
    - switch
      - Switch Case block 2-686
    - while
      - While Iterator block 2-804
  - Coulomb and Viscous Friction block 1-3 2-125
  - Coulomb friction 2-125
  - Counter Limited block 2-129
  - Create Subsystem menu item 2-663
  - current block
    - getting pathname 3-3 4-77
    - handle 3-3 4-78
  - current system
    - getting pathname 3-3 4-79
- ## D
- data object classes
    - Simulink.AliasType 7-7
    - Simulink.Bus 7-32
    - Simulink.BusElement 7-35
    - Simulink.ModelDataLogs 7-79
    - Simulink.ModelWorkspace 7-84
    - Simulink.NumericType 7-105

- Simulink.Parameter 7-112
- Simulink.ParamRTWInfo 7-118
- Simulink.Signal 7-133
- Simulink.StructElement 7-141
- Simulink.StructType 7-143
- Simulink.SubsysDataLogs 7-146
- Simulink.TimeInfo 7-148
- Simulink.TsArray 7-151
- Data Store Memory block 1-14 2-131
- Data Store Read block 1-14 2-140
- Data Store Write block 1-14 2-143
- Data Type Conversion block 1-2 1-13 2-145
- Data Type Propagation block 2-157
- data types
  - propagation 2-157
- Dead Zone block 1-3 2-170
- deadband 2-23
- debug
  - simset parameter 4-145
- debug commands
  - ashow 6-7
  - atrace 6-8
  - break 6-11
  - bshow 6-13
  - clear 6-14
  - continue 6-15
  - disp 6-16
  - emode 6-21
  - etrace 6-22
  - help 6-23
  - nanbreak 6-24
  - next 6-25
  - probe 6-26
  - quit 6-27
  - run 6-29
  - states 6-32
  - status 6-33
  - step 6-34
  - stop 6-37
  - strace 6-38
  - systems 6-40
  - tbreak 6-41
  - trace 6-42
  - undisp 6-43
  - untrace 6-44
  - xbreak 6-47
  - zcbreak 6-48
  - zclist 6-49
- decimation factor 4-145
- decision tables
  - modeling 2-99
- Decrement Stored Integer block 2-177
- Decrement Time To Zero block 2-178
- Decrement To Zero block 2-179
- delaying input by variable amount 2-785
- delete\_block command 3-2 4-20
- delete\_line command 3-2 4-21
- delete\_param command 3-2 4-22
- demos
  - hardstop 2-326
  - sldemo\_clutch 2-326
- Demux block 1-2 1-14 2-180
- Derivative block 1-3 2-187
  - accuracy of 2-187
- derivatives
  - calculating 2-187
  - limiting 2-537
- detachConfigSet command 3-2 4-23
- Detect Decrease block 2-192
- Detect Fall Negative block 2-194
- Detect Fall Nonpositive block 2-195
- Detect Increase block 2-197
- Detect Rise Nonnegative block 2-199
- Detect Rise Positive block 2-201
- differential/algebraic systems
  - modeling 2-11
- Digital Clock block 1-15 2-206
- Discontinuities block library
  - block parameters 8-83
- Discrete block library

- block parameters 8-86
- Discrete Filter block 1-4 2-219
- Discrete State-Space block 1-4 2-222
- discrete state-space model 4-99
- Discrete Transfer Fcn block 1-4 2-242
- Discrete Zero-Pole block 1-4 2-245
- Discrete-Time Integrator block 1-2 1-4 2-225
- discrete-time systems
  - linearization 4-99
- disp command 5-6
- disp debug command 6-16
- Display block 1-15 2-248
  - as floating display 2-250
- displaying
  - signals graphically 2-587
- dlinmod function 4-95
- DocBlock block 1-11 2-253
- Dot Product block 1-8 2-256
- dpoly command 5-7
- droots command 5-7

## E

- eigenvalues of linearized matrix 4-100
- emode debug command 6-21
- Enable block 1-11 2-264
- Enabled and Triggered Subsystem block 1-11 2-266
- Enabled Subsystem block 1-11 2-267
- enabled subsystems
  - Enable block 2-264
- etrace debug command 6-22
- expressions
  - applying to block inputs 2-274
    - MATLAB Fcn block 2-445
- external inputs
  - flag 4-105
  - from workspace 2-349
  - ut 4-135

## F

- Fcn block 1-17 2-274
  - compared to Math Function block 2-438
  - compared to Rounding Function block 2-576
  - compared to Trigonometric Function block 2-742
- files
  - reading from 2-295
  - writing to
    - To File block 2-700
- Filter Direct Form II block 2-714
- Filter Direct Form II Time Varying block 2-717
- Filter First Order block 2-720
- Filter Lead or Lag block 2-722
- Filter Real Zero block 2-725
- find\_system command 3-3 4-30
- finding objects 3-3 4-30
- Finite Impulse Response filter 2-219
- finite-state machines
  - implementing 2-99
- First-Order Hold block 1-4 2-278
- fixdt function 4-36
- fixed step size 4-146
- Fixed-Point Tool 4-58
- fixpt\_interp1 function 4-40
- fixpt\_look1\_func\_approx function 4-42
- fixpt\_look1\_func\_plot function 4-50
- fixpt\_set\_all function 4-52
- fixptbestexp function 4-53
- fixptbestprec function 4-55
  - autoscaling 4-56
- flip-flops
  - implementing 2-99
- float function 4-57
- floating scope
  - definition 2-602
- Floating Scope block 2-587
- for control flow diagram
  - creating 2-284
- For Iterator block 2-284

For Iterator Subsystem block 1-11 2-291  
For subsystems  
  creating 2-284  
format for exporting model states and outputs  
  specifying via `simset` command 4-148  
Forward Euler method 2-225  
Forward Rectangular method 2-225  
`fprintf` command 5-10  
From block 1-14 2-292  
From File block 1-16 2-295  
From Workspace block 1-16 2-299  
Function-Call Generator block 1-12 2-306  
Function-Call Subsystem block 1-12 2-309  
functions  
  `fixdt` 4-36  
  `fixpt_interp1` 4-40  
  `fixpt_look1_func_approx` 4-42  
  `fixpt_look1_func_plot` 4-50  
  `fixpt_set_all` 4-52  
  `fixptbestexp` 4-53  
  `fixptbestprec` 4-55  
  `float` 4-57  
  `fxptdlg` 4-58  
  `num2fixpt` 4-110  
  `sfix` 4-127  
  `sfrac` 4-128  
  `sint` 4-176  
  `ufix` 4-204  
  `ufrac` 4-205  
  `uint` 4-206  
`fxptdlg` function 4-58

## G

gain  
  varying during simulation 2-649  
Gain block 1-2 1-8 2-310  
`gcb` command 3-3 4-77  
`gcbh` command 3-3 4-78  
`gcs` command 3-3 4-79

`get_param` command 3-3 4-80  
`getActiveConfigSet` command 3-3 4-83  
`getConfigSet` command 3-3 4-85  
`getConfigSets` command 3-3 4-86  
global Goto tag visibility 2-317  
Goto block 1-14 2-317  
Goto Tag Visibility block 1-14 2-322  
graphics  
  displaying on mask icon 5-14  
Greek letters  
  displaying on mask icons 5-6  
  using the `text` function 5-18  
Ground block 1-2 1-16 2-324  
GUI  
  Fixed-Point Tool 4-58

## H

handle of current block 3-3 4-78  
hardstop demo 2-326  
`help debug` command 6-23  
Hide Name menu item  
  suppressing display of port label 2-486  
Hit Crossing block 1-4 2-326  
hybrid systems  
  linearization 4-99

## I

IC block 1-13 2-329  
If Action Subsystem block 1-12 2-344  
If block 1-12 2-332  
`if-else` control flow diagram  
  creating 2-332  
image  
  displaying on mask icon 5-11  
  drawing on mask icon using `patch` 5-13  
`image` command 5-11  
Increment Stored Integer block 2-346  
Index Vector block 2-347



- inf values
  - in mask plotting commands 5-14
- Infinite Impulse Response filter 2-219
- inherited
  - data types
    - by backpropagation 2-157
  - scaling
    - by backpropagation 2-157
- initial conditions
  - setting 2-329
- initial states 4-146
- initial step size 4-146
- Inport block 1-2 1-12 1-16 2-348
- Inport blocks
  - in subsystem 2-663
  - linmod function 4-99
- input ports
  - unconnected 2-324
- inputs
  - applying expressions to 2-274
  - applying MATLAB function to
    - Fcn block 2-274
    - MATLAB Fcn block 2-445
  - combining into vector line 2-483
  - delaying by variable amount 2-785
  - external 4-135
  - from outside system 2-348
  - from previous time step 2-453
  - from workspace 2-349
  - generating step between two levels 2-658
  - interpolated mapping 2-422
  - logical operations on 2-396
  - multiplying block inputs during
    - simulation 2-649
  - outputting minimum or maximum 2-463
  - passing through stair-step function 2-530
  - piecewise linear mapping of two 2-413
  - plotting 2-813
  - reading from file 2-295
  - width of 2-810

- integration
  - block input 2-361
  - discrete-time 2-225
- Integrator block 1-2 to 1-3 2-361
- interpolated mapping 2-422
- Interpolation Using Prelookup block 1-7 2-380
- Interval Test Dynamic block 2-391

**J**

- Jacobians 4-99

**L**

- left-hand approximation 2-225
- legacy\_code function 4-88
- limiting
  - signals 2-578
- limiting derivative of signal 2-537
- limiting integral 2-363
- linear models
  - extracting
    - linmod function 4-99
- linearization
  - discrete-time systems 4-99
  - linmod function 4-99
- linearized matrix
  - eigenvalues 4-100
- LineDefaults section of mdl file 9-7
- lines
  - adding 3-2 4-6
  - deleting 3-2 4-21
- linmod function 4-95
  - Transport Delay block 2-728
- linmod2 function 4-95
- linmodv5 function 4-95
- local Goto tag visibility 2-317
- Logic and Bit Operations block library
  - block parameters 8-96
- logic circuits

- modeling 2-99
- Logical Operator block 2-396
- Look-Up Table (2-D) block 1-7 2-413
- Look-Up Table (n-D) block 1-7 2-422
- Lookup Table block 1-7 2-403
- Lookup Tables block library
  - block parameters 8-100

## M

### MACs

- propagating data type information for 2-163

- Magnitude-Angle to Complex block 1-8 2-433

- Manual Switch block 1-14 2-436

- mask icon 5-4

- displaying graphics on 5-14
- displaying image on 5-11
- displaying port label on 5-16
- displaying symbols and Greek letters on 5-18
- displaying text on 5-6
- displaying text using fprintf 5-10
- displaying text using text 5-18
- displaying transfer function on 5-7
- using the patch function 5-13

- mask icons

- changing plot colors on 5-4
- displaying symbols and Greek letters on 5-6
- question marks in 5-14

- mask parameters

- undefined 5-8

- masked blocks

- parameters 8-183

- masked subsystems

- question marks in icon 5-14

- masking bits 2-41

- Math block library

- block parameters 8-107

- Math Function block 1-8 2-437

- mathematical functions

- performing

- Math Function block 2-437

- Rounding Function block 2-576

- Trigonometric Function block 2-742

- mathematical symbols

- displaying on mask icons 5-6

- displaying on mask icons using text 5-18

- MATLAB character encoding, changing 3-4 4-179

- MATLAB Fcn block 1-17 2-445

- MATLAB functions

- applying to block input

- Fcn block 2-274

- MATLAB Fcn block 2-445

- matrices

- writing to 2-704

- Matrix Concatenate block 2-448

- maximum number of output rows 4-147

- maximum order of ode15s solver 4-146

- maximum step size

- simset command 4-147

- mdl file 9-2

- Memory block 1-4 2-453

- memory region

- shared

- Data Store Memory block 2-131

- Data Store Read block 2-140

- Data Store Write block 2-143

- Merge block 1-14 2-457

- minimum step size

- simset command 4-147

- MinMax block 1-8 2-463

- model files 9-2

- Model Info block 1-11 2-474

- model parameters

- table 8-2

- Model Verification block library

- block parameters 8-123

- Model-Wide Utilities block library

- block parameters 8-127

- models
  - closing 3-2 4-14
  - creating
    - new\_system command 3-3 4-108
  - getting name 3-2 4-15
  - parameters 8-2
  - replacing blocks 3-3 4-117
  - simulating 3-6 4-133
- multiplying block inputs
  - during simulation 2-649
- Multiport Switch block 1-14 2-477
- multirate systems
  - linearization 4-99
- Mux block 1-2 1-14 2-483

## N

- Nan values
  - in mask plotting commands 5-14
- nanbreak debug command 6-24
- new\_system command 3-3 4-108
- next debug command 6-25
- nonlinear systems
  - spectral analysis of 2-94
- normally distributed random numbers 2-534
- num2fixpt function 4-110

## O

- objects
  - finding 3-3 4-30
- obsolete blocks, replacing 3-5 4-194
- ode113 solver
  - Memory block 2-453
- ode14x solver
  - extrapolation order 4-146
  - number of Newton iterations 4-147
- ode15s solver
  - maximum order property 4-146
  - Memory block 2-453

- open\_system command 3-3 4-113
- openDialog command 3-3 4-116
- opening
  - block dialog boxes 3-3 4-113
  - Simulink Library Browser 3-4 4-150
  - system windows 3-3 4-113
- operating point 4-96
- options structure
  - getting values 3-6 4-137
  - setting values 3-6 4-144
- Output block 1-2 1-12 1-15 2-486
- Output blocks
  - in subsystem 2-663
  - linmod function 4-99
- output
  - maximum rows 4-147
  - outside system 2-486
  - refine factor 4-147
  - selected elements of input vector 2-611
  - selected information about the signal on
    - input 2-520
  - specifying points 4-147
  - switching between two inputs 2-436
  - values
    - displaying 2-248
  - variables 4-147
  - writing to file
    - To File block 2-700
  - writing to workspace
    - To Workspace block 2-704
  - zero within range 2-170
- output ports
  - capping unconnected 2-695

## P

- parameters
  - adding 3-2 4-8
  - block
    - list 8-66

- deleting 3-2 4-22
- getting values of 3-3 4-80
- masked blocks 8-183
- model 8-2
- setting values of
  - set\_param command 3-4 4-124
- patch command 5-13
- phase-shifted wave 2-624
- piecewise linear mapping
  - two inputs 2-413
- piecewise linear signal
  - generating
    - Signal Builder block 2-624
- plot command 5-14
- plotting input signals
  - Scope block 2-587
  - XY Graph block 2-813
- plotting simulation data 3-6 4-139
- port label
  - displaying on mask icon 5-16
- port labels
  - suppressing display 2-486
- port\_label command 5-16
- Ports & Subsystems block library
  - block parameters 8-129
- precision
  - best 4-53
  - maximum 4-55
- probe debug command 6-26
- Product block 1-2 1-9 2-512
- Product of Elements Inverted block 2-519
- programmable logic arrays
  - modeling 2-99
- propagation of data types 2-157
- properties of Scope block 2-597
- Pulse Generator block 1-16 2-524

## Q

- Quantizer block 1-4 2-530

- question marks in mask icon 5-14
- quit debug command 6-27

## R

- random noise
  - generating 2-534
- Random Number block 1-16 2-534
  - and Band-Limited White Noise block 2-30
  - compared to Band-Limited White Noise block 2-534
- random numbers
  - generating normally distributed 2-30
  - normally distributed 2-534
  - uniformly distributed 2-747
- Rate Limiter block 1-4 2-537
- Rate Transition block 1-13 2-541
- reading data
  - from data store 2-140
  - from file 2-295
  - from workspace 2-299
- Real-Imag to Complex block 1-9 2-547
- refine factor
  - simset command 4-147
- region of zero output 2-170
- regular expressions 4-33
- relative tolerance 4-148
- Repeating Sequence block 1-16 2-561
- Repeating Sequence Stair block 2-569
- repeating signals 2-561
- replace obsolete blocks 3-5 4-194
- replace\_block command 3-3 4-117
- replacing blocks in model 3-3 4-117
- Reshape block 1-9 2-573
- right-hand approximation 2-226
- Rounding Function block 1-9 2-576
- run debug command 6-29

**S**

- S-Function block 2-616
- S-Function Builder block 2-619
- Sample Time Divide block 2-799
- Sample Time Multiply block 2-800
- Sample Time Probe block 2-800
- Sample Time Subtract block 2-800
- sample-and-hold
  - applying to block input 2-453
- sampling interval
  - generating simulation time 2-206
- Saturation block 2-578
- save\_system command 3-3 4-119
- sawtooth wave
  - generating 2-628
- Scope axes
  - autoscaling 2-591
- Scope block 2-587
  - properties 2-597
  - saving axes settings 2-597
- Scope Block
  - displaying multiple signals 2-589
  - trace colors 2-589
- Scope Viewer
  - displaying signals 2-588
  - line styles 2-588
  - trace colors 2-588
- scoped Goto tag visibility 2-317
- Selector block 2-611
- separating vector signal 2-180
- sequence of signals 2-524
- sequential circuits
  - implementing 2-101
- set\_param command 3-4 4-124
- setActiveConfigSet command 3-3 4-126
- setting bits 2-41
- setting parameter values 3-4 4-124
- sfix function 4-127
- sfrac function 4-128
- shared data store
  - Data Store Memory block 2-131
  - Data Store Read block 2-140
  - Data Store Write block 2-143
- Sign block 2-622
- Signal Attributes block library
  - block parameters 8-153
- Signal Generator block 2-628
- Signal Inspection block 1-13 2-520
- signal logging
  - enabling
    - simset command 4-149
- signal logging name
  - specifying
    - simset command 4-149
- Signal Routing block library
  - block parameters 8-159
- Signal Specification block 2-633
- Signal Viewer Scope 2-587
- signals
  - displaying graphically 2-587
  - displaying vector 2-588
  - displaying X-Y plot of 2-813
  - generating pulses 2-524
  - limiting 2-578
  - limiting derivative of 2-537
  - passed from Goto block 2-292
  - passing to From block 2-317
  - plotting
    - Scope block 2-587
    - XY Graph block 2-813
  - repeating 2-561
- sim command 3-6 4-133
- simget command 3-6 4-137
- simplot command
  - plotting simulation data 3-6 4-139
- simset command 3-6 4-144
- simulating models 3-6 4-133
- simulation

- parameters
    - specifying using `simset` command 3-6 4-144
  - stopping
    - Stop Simulation block 2-661
  - simulation commands
    - `Simulink.BlockDiagram.getChecksum` 4-158
    - `Simulink.BlockDiagram.getInitialState` 4-161
    - `Simulink.SubSystem.getChecksum` 4-173
  - simulation time
    - generating at sampling interval 2-206
    - outputting 2-97
  - `simulink` command 3-4 4-150
  - Simulink Library Browser
    - opening 3-4 4-150
  - `Simulink.AliasType` 7-7
  - `Simulink.BlockDiagram.addBusToVector`
    - command 3-4 4-151
  - `Simulink.BlockDiagram.copyContentsToSubSystem`
    - command 3-4 4-155
  - `Simulink.BlockDiagram.deleteContents`
    - command 3-4 4-157
  - `Simulink.BlockDiagram.getChecksum` command
    - description 4-158
  - `Simulink.BlockDiagram.getInitialState`
    - command
    - description 4-161
  - `Simulink.Bus` 7-32
  - `Simulink.Bus.cellToObject` command 3-4 4-163
  - `Simulink.Bus.createObject` command 3-4 4-164
  - `Simulink.Bus.objectToCell` command 3-4 4-165
  - `Simulink.Bus.save` command 3-4 4-166
  - `Simulink.BusElement` 7-35
  - `Simulink.ConfigSet` section of mdl file 9-5
  - `Simulink.ModelDataLogs` 7-79
  - `Simulink.ModelWorkspace` 7-84
  - `Simulink.NumericType` 7-105
  - `Simulink.Parameter` 7-112
  - `Simulink.ParamRTWInfo` 7-118
  - `Simulink.Signal` 7-133
  - `Simulink.StructElement` 7-141
  - `Simulink.StructType` 7-143
  - `Simulink.SubsysDataLogs` 7-146
  - `Simulink.SubSystem.convertToModelReference`
    - command 3-4 4-167
  - `Simulink.SubSystem.copyContentsToBlockDiagram`
    - command 3-4 4-170
  - `Simulink.SubSystem.deleteContents`
    - command 3-4 4-172
  - `Simulink.SubSystem.getChecksum` command
    - description 4-173
  - `Simulink.TimeInfo` 7-148
  - `Simulink.TsArray` 7-151
- sine wave
    - generating
      - Signal Generator block 2-628
      - Sine Wave block 2-642
    - generating with increasing frequency
      - Chirp Signal block 2-94
  - Sine Wave block 2-642
  - Sinks block library
    - block parameters 8-166
  - `sint` function 4-176
  - Slider Gain block 1-9 2-649
  - `slreplace_mux` command 3-5 4-192
  - `slupdate` command 3-5 4-194
  - solvers
    - properties
      - specifying 3-6 4-144
      - specifying using `simset` command 4-148
  - Sources block library
    - block parameters 8-170
  - spectral analysis of nonlinear systems 2-94
  - square wave
    - generating 2-628
  - Squeeze block 2-651
  - `ss2tf` function 4-101

- ss2zp function 4-101
- stair-step function
  - passing signal through 2-530
- state derivatives
  - setting to zero 4-196
- state space in discrete system 2-222
- State-Space block 2-653
- states
  - initial 4-146
  - outputting 4-147
  - resetting 2-364
  - saving at end of simulation 4-146
  - specifying absolute tolerance for 2-370
- states debug command 6-32
- status debug command 6-33
- Step block 2-658
- step debug command 6-34
- stop debug command 6-37
- Stop Simulation block 2-661
- stopping simulation 2-661
- strace debug command 6-38
- Subsystem block 2-663
- subsystems
  - and Inport blocks 2-348
  - enabled 2-264
- Subtract block 2-675
- Sum block 2-675
- Sum of Elements block 2-675
- Switch Case Action Subsystem block 2-691
- switch control flow diagram
  - creating 2-686
- switching output between inputs
  - Manual Switch block 2-436
- switching output between two inputs 2-436
- System section of mdl file 9-7
- system windows
  - closing 3-2 4-16
- systems
  - current 3-3 4-79
  - saving 3-3 4-119

- systems debug command 6-40

## T

- tbreak debug command 6-41
- Terminator block 2-695
- terminators
  - adding 3-2 4-9
- TeX formatting commands
  - using in mask icon text 5-18
  - using with disp 5-6
- text command 5-18
- tf2ss utility
  - converting Transfer Fcn to state-space form 2-710
- time delay
  - simulating 2-727
- Time-Based Linearization block 2-696
- To File block 2-700
- To Workspace block 2-704
- Trace colors
  - Scope Block 2-589
  - Scope Viewer 2-588
- trace debug command 6-42
- tracing facilities 4-148
- Transfer Fcn block 2-709
- transfer function form
  - converting to 4-101
- transfer functions
  - discrete 2-242
  - displaying on mask icon 5-7
  - linear 2-709
  - poles and zeros 2-820
    - discrete 2-245
- Transport Delay block 2-727
- Trapezoidal method 2-227
- Trigger block 2-731
- Trigger-Based Linearization block 2-737
- Triggered Subsystem block 2-741
- triggered subsystems

- Trigger block 2-731
- Trigonometric Function block 2-742
- trim function 4-196
- truth tables
  - implementing 2-99

## U

- ufix function 4-204
- ufrac function 4-205
- uint function 4-206
- unconnected input ports 2-324
- unconnected output ports
  - using the Terminator block 2-695
- undisp debug command 6-43
- Uniform Random Number block 2-747
  - compared to Band-Limited White Noise block 2-747
- uniformly distributed random numbers 2-747
- Unit Delay block
  - compared to Transport Delay block 2-727
- Unit Delay Enabled External IC block 2-756
- Unit Delay Enabled Resetable block 2-758
- Unit Delay Enabled Resetable External IC block 2-761
- Unit Delay External IC block 2-764
- Unit Delay Resetable block 2-766
- Unit Delay Resetable External IC block 2-768
- Unit Delay With Preview Enabled block 2-770
- Unit Delay With Preview Enabled Resetable block 2-773
- Unit Delay With Preview Enabled Resetable External RV block 2-776
- Unit Delay With Preview Resetable block 2-779
- Unit Delay With Preview Resetable External RV block 2-782
- untrace debug command 6-44
- Update Diagram menu item
  - changing block parameters during simulation 4-124

- User-defined functions block library
  - block parameters 8-178

## V

- variable time delay 2-785
- Variable Time Delay block 1-3 2-785
- Variable Transport Delay block 2-785
- vdp model
  - Scope block 2-591
- Vector Concatenate block 2-448
- vector signals
  - displaying 2-588
  - generating from inputs 2-483
  - separating 2-180
- viscous friction 2-125
- visibility of Goto tag 2-322

## W

- while control flow diagram
  - creating 2-804
- While Iterator block 2-804
- While Iterator Subsystem block 2-809
- While subsystems
  - creating 2-804
- white noise
  - generating 2-30
- Width block 2-810
- workspace
  - destination 4-146
  - reading data from 2-299
  - source 4-148
  - writing output to 2-704
- writing data to data store 2-143
- writing output to file 2-700
- writing output to workspace 2-704

## X

- xbreak debug command 6-47



XY Graph block 2-813

## **Z**

zcbreak debug command 6-48

zclist debug command 6-49

zero crossings

    detecting

        Hit Crossing block 2-326

        simset command 4-149

zero output in region

    generating 2-170

Zero-Pole block 2-820

zero-pole form

    converting to 4-101

zooming in on displayed data 2-593